

## AIMB-216

**AIMB-216 Intel® Pentium N3710  
& Celeron N3160/N3010 Mini-ITX  
DVI-D/HDMI (or LVDS)/DP (or  
eDP), 6 COM, and Dual LAN, 6  
USB, 1 MiniPCle and 1 M.2 B key,  
PCIe x1**

---

## Copyright

The documentation and the software included with this product are copyrighted 2018 by Advantech Co., Ltd. All rights are reserved. Advantech Co., Ltd. reserves the right to make improvements in the products described in this manual at any time without notice. No part of this manual may be reproduced, copied, translated or transmitted in any form or by any means without the prior written permission of Advantech Co., Ltd. Information provided in this manual is intended to be accurate and reliable. However, Advantech Co., Ltd. assumes no responsibility for its use, nor for any infringements of the rights of third parties, which may result from its use.

## Acknowledgements

IBM and PC are trademarks of International Business Machines Corporation. Intel® Pentium/Celeron N3710/N3160/N3010 is trademark of Intel Corporation WinBond is a trademark of Winbond Corporation.

All other product names or trademarks are the property of their respective owners.

# Message to the Customer

## Advantech Customer Services

Every Advantech product is built with the most exact specifications to ensure reliable performance in the harsh and demanding conditions typical of industrial environments. Whether your new Advantech equipment is destined for a laboratory or factory floor, be assured that your product can provide the reliability and ease of operation for which the name Advantech is renowned.

Your satisfaction is our primary concern. A guide to Advantech's customer services is provided below. To ensure that you receive the full benefit of our services, please follow the instructions below.

## Technical Support

We want you to get the maximum performance from your products. Should you encounter any technical difficulties, we are available to provide assistance. Answers to the most frequently asked questions are provided in the product documentation. These answers are typically a lot more detailed than the ones provided over the phone.

So please consult this manual first. If you still cannot find the answer, gather all relevant information or questions that apply to your problem, and with the product close to hand, call your dealer. Our dealers are well trained and ready to provide the support required for you to experience the most from your Advantech products. Most of the problems reported are minor and can be easily solved over the phone.

In addition, free technical support from Advantech engineers is available every business day. We are always willing to give advice on application requirements or specific information regarding the installation and operation of any of our products.

---

# Declaration of Conformity

## FCC Class B

This device complies with the requirements in Part 15 of the FCC regulations: Operation is subject to the following two conditions:

- This device may not cause harmful interference.
- This device must accept any interference received, including interference that may cause undesired operation.

This equipment has been tested and found to comply with the limits for a Class B digital device, pursuant to Part 15 of the FCC Regulations. These limits are designed to provide reasonable protection against harmful interference when the equipment is operated in a commercial environment. This equipment generates, uses, and can radiate radio frequency energy and, if not installed and used in accordance with the instruction manual, may cause harmful interference to radio communications. Operation of this device in a residential area is likely to cause harmful interference, in which case users are required to correct the interference at their own expense. The user is advised that any equipment changes or modifications not expressly approved by the party responsible for compliance would void compliance with the FCC regulations and, therefore, the user's authorization to operate the equipment.

**Caution!** *There is a risk of a new battery exploding if incorrectly installed. Do not attempt to recharge, force open, or heat the battery. Replace the battery only with the same or equivalent type recommended by the manufacturer. Discard used batteries according to the manufacturer's instructions.*





# Memory Compatibility

## AIMB-216 Memory Compatibility List

Category	Speed	Capacity	Chip_Vendor	Chip_PN	ADVANTECH P/N	Result
DDR3L	1600	2GB	Advantech	SEC 310 XYK0 K4B2G084GD	AQD-SD3L2GN16-SQ	PASS
DDR3L	1600	4GB	Advantech	SEC 407 XYK0 K4B4G0846B	AQD-SD3L4GN16-SG	
PASS						
DDR3L	1600	4GB	ATP	4JE77 D9QBJ	N/A	PASS
DDR3L	1600	4GB	Advantech	SEC 546 BYNA K4B2G0846Q	AQD-SD3L4GN16-SQ	PASS
DDR3L	1333	2GB	Transcend	SEC 234 HYK0 K4B2G0846D	N/A	PASS
DDR3L	1333	4GB	Apacer	4JE77 D9QBJ	96SD3L-4G1333NN-AP	PASS
DDR3L	1600	4GB	Kingston	KVR16LS11/4	N/A	PASS
DDR3L	1600	1GB	Advantech	SK hynix	AQD-SD3L1GN16-HC	PASS
DDR3L	1333	4GB	Apacer	78.B2GCY.AT00C	N/A	PASS
DDR3L	1600	4GB	Kingston	KVR16LS11/4	N/A	PASS
DDR3L	1600	8GB	Advantech	SEC 422 BYK0 K4B4G0846D	SQR-SD3I-8G1600SNL	PASS
DDR3L	1600	8GB	ADATA	Micron	N/A	PASS

## Ordering Information

P/N	CPU	Memory	HDMI or LVDS	DVI-D	DP/ eDP	GbE LAN	COM	SATA III	USB 3.0/ 2.0	Mini-PCIe	M.2	TPM	AMP	PCIe x1	Thermal solution
AIMB-216D-S6A1E	N3710	2	1	1	1 / (1)	2	6	2	4/2	1 x F/S	1	(1)	(2 x 6W)	1	Passive
AIMB-216N-S6A1E	N3160	2	1	1	1 / (1)	2	6	2	4/2	1 x F/S	1	(1)	(2 x 6W)	1	Passive
AIMB-216U-S6A1E	N3010	2	1	1	1 / (1)	2	6	2	4/2	1 x F/S	1	(1)	(2 x 6W)	1	Passive
AIMB-216L-S6A1E	N3160	2	1 (LVDS only)	1	0	1	2	1(SAT A1)	4(USB1-4)	1 x F/S	0	(1)	(2 x 6W)	1	Passive

\* ( ) is not populated when MP

---

## Product Warranty (2 years)

Advantech warrants to you, the original purchaser, that each of its products will be free from defects in materials and workmanship for two years from the date of purchase.

This warranty does not apply to any products which have been repaired or altered by persons other than repair personnel authorized by Advantech, or which have been subject to misuse, abuse, accident or improper installation. Advantech assumes no liability under the terms of this warranty as a consequence of such events.

Because of Advantech's high quality-control standards and rigorous testing, most of our customers never need to use our repair service. If an Advantech product is defective, it will be repaired or replaced at no charge during the warranty period. For out-of-warranty repairs, you will be billed according to the cost of replacement materials, service time and freight. Please consult your dealer for more details.

If you think you have a defective product, follow these steps:

1. Collect all the information about the problem encountered. (For example, CPU speed, Advantech products used, other hardware and software used, etc.) Note anything abnormal and list any onscreen messages you get when the problem occurs.
2. Call your dealer and describe the problem. Please have your manual, product, and any helpful information readily available.
3. If your product is diagnosed as defective, obtain an RMA (return merchandise authorization) number from your dealer. This allows us to process your return more quickly.
4. Carefully pack the defective product, a fully-completed Repair and Replacement Order Card and a photocopy proof of purchase date (such as your sales receipt) in a shippable container. A product returned without proof of the purchase date is not eligible for warranty service.
5. Write the RMA number visibly on the outside of the package and ship it prepaid to your dealer.

## Initial Inspection

Before installing the motherboard, please ensure that the following items are included in your shipment:

- 1x AIMB-216 Intel® Pentium N3710 & Celeron N3160/N3010 Mini-ITX motherboard
- 1 x SATA HDD cable
- 1 x SATA power cable
- 1 x Serial port cable (1 to 4), for AIMB-216D/N/U SKU only
- 2 x Serial port cable (1 to 1)
- 1 x I/O port bracket
- 1 x startup manual
- 1 x warranty card
- 1 x on-board CPU heat sink

If any of these items are missing or damaged, contact your distributor or sales representative immediately. All AIMB-216 devices are mechanically and electrically inspected before shipment. Thus, your product should be free of marks and scratches and in perfect working order upon receipt. While unpacking AIMB-216, check the product for signs of shipping damage (for example, a damaged box, scratches, dents, etc.). If the device is damaged or fails to meet the specifications, notify our service department or your local sales representative immediately. Please also notify the carrier. Retain the shipping carton and packing material for inspection by the carrier. After this inspection, we will make arrangements to repair or replace the unit.



# Contents

<b>Chapter 1</b>	<b>General Information .....</b>	<b>1</b>
1.1	Introduction .....	2
1.2	Features .....	2
1.3	Specifications .....	2
1.3.1	System .....	2
1.3.2	Memory .....	3
1.3.3	Input/Output .....	3
1.3.4	Graphics.....	3
1.3.5	Ethernet LAN .....	3
1.3.6	Industrial Features .....	3
1.3.7	Mechanical and Environmental Specifications.....	3
1.4	Jumpers and Connectors .....	4
	Table 1.1: Connector / Header List.....	4
1.5	Board Layout: Jumper and Connector Locations.....	6
	Figure 1.1 Jumper and Connector Locations.....	6
	Figure 1.2 I/O Connectors .....	6
1.6	AIMB-216 Board Diagram .....	7
	Figure 1.3 AIMB-216 Board Diagram .....	7
1.7	Safety Precautions .....	8
1.8	Jumper Options.....	9
1.8.1	Setting Jumpers .....	9
1.8.2	CMOS Mode Selection (JCMOS1) .....	9
	Table 1.2: CMOS Mode Selection (JCMOS1).....	9
1.8.3	COM3 RS-232/422/485 Mode Selector (JSETCOM3).....	10
	Table 1.3: COM3 RS-232/422/485 (JSETCOM3) .....	10
	Table 1.4: COM3 RS-232/422/485 (JSETCOM3) .....	10
1.8.4	LVDS Panel Voltage Selection (JLVDS1).....	11
	Table 1.5: LVDS Panel Voltage Selection (JLVDS1) .....	11
1.8.5	PSON1: ATX and AT Mode Selector .....	11
	Table 1.6: PSON1: ATX and AT Mode Selector.....	11
1.8.6	JWDT1 + JOBS1: Watchdog Timer Output and OBS Beep .....	12
	Table 1.7: JWDT1 + JOBS1: Watchdog Output & OBS Beep... ..	12
1.8.7	Case Open Pin Header Selection (JCASEOP_SW1).....	12
	Table 1.8: Case Open Pin Header (JCASEOP_SW1) .....	12
1.8.8	Power Switch/HDD LED/SMBus/Speaker (JFP1 + JFP2) .....	12
	Table 1.9: Power Switch/HDD LED/SMBus/Speaker (JFP1 + JFP2).....	12
1.8.9	EDP Panel Voltage Selection (JEDP1) (Optional).....	13
	Table 1.10:EDP Panel Voltage Selection (JEDP1) (Optional)....	13
1.8.10	JEIDA/VESA Selection (VCON1).....	13
	Table 1.11:JEIDA/VESA Selection (VCON1) .....	13
1.8.11	RS-485/422 Terminal Resistor Jumper (SW_422_1) .....	14
	Table 1.12:RS-485/422 Terminal Resistor (SW_422_1) .....	14
1.8.12	COM6 5V/12V selection (JSETCOM6_V1).....	14
	Table 1.13:COM6 5V/12V selection (JSETCOM6_V1) .....	14
	Table 1.14: .....	14
1.8.13	LVDS1 backlight control (JVBR1).....	15
	Table 1.15:LVDS1 backlight control (JVBR1).....	15
1.8.14	eDP and LVDS2 backlight control (JVBR2).....	15
	Table 1.16:LVDS1 backlight control (JVBR2).....	15
1.8.15	For SATA1 to support SATA DOM (JSATAPWR1) .....	16
	Table 1.17:For SATA1 to support SATA DOM (JSATAPWR1)..	16
1.8.16	Power LED and PS2 keyboard control (JFP3).....	16
	Table 1.18:Power LED and PS2 keyboard control (JFP3) .....	16

## Chapter 2 Connecting Peripherals..... 19

2.1	Introduction .....	20
2.2	LAN and USB Ports .....	20
	Table 2.1: LAN LED Indicators .....	20
2.3	DVI-D Connector (DVI_1) .....	21
2.4	Serial Ports (COM1 ~ COM6) .....	21
2.5	PS/2 Keyboard and Mouse Connector (KBMS1) .....	22
2.6	Display Port Connector (DP1) .....	22
2.7	HDMI connector (HDMI1) .....	23
2.8	CPU and System FAN Connector (CPU1 and SYSFAN1) .....	23
2.9	Front Panel Connectors (JFP3/JFP1 + JFP2) .....	24
2.9.1	ATX Soft Power Switch (JFP1 + JFP2/PWR_SW) .....	24
2.9.2	Reset (JFP1 + JFP2/RESET) .....	24
2.9.3	HDD LED (JFP1 + JFP2/HDDLED) .....	24
2.9.4	External Speaker (JFP1 + JFP2/SPEAKER) .....	24
2.9.5	Power LED and Keyboard Lock Connector (JFP3/PWR_LED and KEY LOCK) .....	25
	Table 2.2: ATX Power Supply LED Status (AT power not support- ed) .....	25
2.10	Line-Out Connector (AUDIO1) .....	25
2.11	Serial ATA Interface (SATA1/2) & SATADOM Power Pin Header (JSATAPWR1) .....	26
2.12	PCI-Express x1 Slot (PCIEX1_1) .....	26
2.13	Front Panel Audio Connector (FP_AUDIO1) .....	27
2.14	ATX 12V Power Connector (ATX12V1) .....	27
2.15	SPI Flash Connector(SPI1_1) .....	28
2.16	LVDS Backlight Inverter Power Connector (INV1) .....	28
2.17	LVDS Connector (LVDS1) .....	29
2.18	General Purpose I/O Connector (GPIO1) .....	29
2.19	CMOS Battery Wafer Box (BAT1) .....	30
2.20	SPI BIOS Socket (BIOS1) .....	30
2.21	SPDIF Interface Pin Header (SPDIF_OUT1) .....	31
2.22	Audio Amplifier Output Pin Header (JAMP1) (BOM Optional) .....	31
2.23	ATX Power Supply (5VSB) Connector (ATX_5V1) .....	32
2.24	SATA Power Connector (SATA_PWR1/2) .....	32
2.25	Case Open Pin Header (JCASE1) .....	33
2.26	DDR3L SODIMM Socket (DIMM1/2) .....	33
2.27	Mini-PCIe Connector (MINIPCI1) .....	34
2.28	M.2 B key connector (NGFF1) .....	34
2.29	RTC Reset Pin Header (JCMOS1) .....	35
2.30	eDP Connector (eDP1), BOM optional .....	35
2.31	eDP & LVDS2 Backlight Inverter Power Connector (INV2), BOM optional 36	
2.32	LVDS2 control signal pin header (LVDS2), BOM optional .....	36

## Chapter 3 BIOS Operation ..... 37

3.1	Introduction .....	38
3.2	BIOS Setup .....	38
3.2.1	Main Menu .....	39
3.2.2	Advanced BIOS Features .....	40
3.2.3	Chipset .....	61
3.2.4	Security .....	71
3.2.5	Boot .....	73
3.2.6	Save and Exit .....	74

## Chapter 4 Software and Service Introduction. 75

4.1	Introduction .....	76
4.2	Value-Added Software Services .....	76
4.2.1	Software API .....	76
4.2.2	Software Utility .....	78
<b>Chapter 5</b>	<b>Chipset Software Install Utility .....</b>	<b>79</b>
5.1	Before Installation .....	80
5.2	Introduction .....	80
<b>Chapter 6</b>	<b>VGA Setup .....</b>	<b>81</b>
6.1	Introduction .....	82
6.2	Windows 7/8.1/10 .....	82
<b>Chapter 7</b>	<b>LAN Configuration .....</b>	<b>83</b>
7.1	Introduction .....	84
7.2	Features .....	84
7.3	Installation .....	84
7.4	Windows 7/8.1/10 Driver Setup (Realtek 8111G) .....	84
<b>Chapter 8</b>	<b>XHCI Driver Installation for USB Setup</b>	<b>85</b>
8.1	Introduction .....	86
8.2	Installation .....	86
<b>Appendix A</b>	<b>Programming the Watchdog Timer ..</b>	<b>87</b>
A.1	Programming the Watchdog Timer .....	88
A.1.1	Watchdog Timer Overview .....	88
A.1.2	Programming the Watchdog Timer .....	88
	Table A.1: Watchdog Timer Registers .....	90
A.1.3	Example Program .....	91
<b>Appendix B</b>	<b>I/O Pin Assignments .....</b>	<b>97</b>
B.1	ATX Power Supply (5VSB) Connector (ATX_5V1) .....	98
	Table B.1: ATX_5V1 .....	98
B.2	eDP Connector (eDP1), BOM optional .....	98
	Table B.2: EDP1 .....	98
B.3	LVDS2 Control Signal Pin Header (LVDS2), (BOM option) .....	99
	Table B.3: LVDS2 .....	99
B.4	Inverter Power Connector (INV2), (BOM option) .....	99
	Table B.4: INV2 .....	99
B.5	LVDS1 Control Signal Pin Header (LVDS1) .....	100
	Table B.5: LVDS1 .....	100
B.6	Audio Amplifier Output Pin Header (JAMP1), (BOM option) .....	101
	Table B.6: JAMP1 .....	101
B.7	Front Panel Audio Connector (FP_AUDIO1) .....	102
	Table B.7: FP_AUDIO1 .....	102
B.8	LVDS Backlight Inverter Power Connector (INV1) .....	102
	Table B.8: INV1 .....	102

B.9	SPDIF Interface Pin Header (SPDIF_OUT1).....	103
	Table B.9: SPDIF_OUT1 .....	103
B.10	COM1 Box Header (COM1).....	103
	Table B.10:COM1 .....	103
B.11	COM2 Pin Header (COM2).....	104
	Table B.11:COM2 .....	104
B.12	USB2.0 Pin Header (USB0506).....	104
	Table B.12:USB0506 .....	104
B.13	USB2.0 Pin Header (USB0708), (BOM option) .....	105
	Table B.13:USB0708 .....	105
B.14	COM3 ~ COM6 Box Header (COM3456) .....	105
	Table B.14:COM3456 .....	105
B.15	SATA Power Connector (SATA_PWR1/2).....	106
	Table B.15:SATA_PWR1,SATA_PWR2.....	106
B.16	Power LED and Keyboard Lock Pin Header (JFP3).....	107
	Table B.16:JFP3 .....	107
B.17	General Purpose I/O Connector (GPIO1).....	107
	Table B.17:GPIO1 .....	107
B.18	CPU Fan and System Fan Connectors (CPUFAN1,SYSFAN1).....	108
	Table B.18:CPUFAN1,SYSFAN1 .....	108
B.19	Front Panel Connectors (JFP1 + JFP2).....	108
	Table B.19:JFP1+JFP2 .....	108
B.20	PS/2 Keyboard and PS/2 Mouse Connector (KBMS1).....	109
	Table B.20:KBMS1 .....	109
B.21	USB2.0 Connector (USB0910), (BOM option).....	109
	Table B.21:USB0910 .....	109
B.22	Case Open Pin Header (JCASE1).....	110
	Table B.22:JCASE1 .....	110
B.23	CMOS Battery Wafer Box (BAT1).....	110
	Table B.23:BAT1 .....	110
B.24	SPI BIOS Socket (SPI1_1) .....	110
	Table B.24:SPI1_1.....	110
B.25	ATX 12 V Power Supply Connector (ATX12V1).....	111
	Table B.25:ATX12V1 .....	111
B.26	HD Analog Audio Interface (AUDIO1).....	111
	Table B.26:AUDIO1 .....	111
B.27	High Definition Connector (HDMI1) .....	112
	Table B.27:HDMI1 .....	112
B.28	Display Port Connector (DP1).....	113
	Table B.28:DP1 .....	113
B.29	Digital Visual Interface (DVI_1).....	114
	Table B.29:DVI_1 .....	114



# Chapter 1

General Information

## 1.1 Introduction

The AIMB-216 with Intel® Pentium N3710 & Celeron N3160/N3010 processor is designed for industrial applications that require enhanced computing performance and power management capabilities. The motherboard features an onboard Intel® Pentium™ N3710 quad-core 1.6 GHz and Celeron N3160 quad-core 1.6 GHz and N3010 dual-core 1.04 GHz CPU with DDR3L 1600 MHz of up to 8 GB.

The AIMB-216 offers rich I/O connectivity with four USB 3.0 and six USB 2.0 ports (USB78910 is an optional BOM), as well as six COM ports integrated in a standard 170 x 170 mm form factor. The system also supports triple display for DVI-D, HDMI (or LVDS), DP (or eDP). AIMB-216 also features numerous connectivity and expansion options, including PCIe x1, 8-bit GPIO, two SATA III 6 GB/s connectors, an optional TPM security feature, and one Mini-PCIe and one M.2 (B key) expansion slots for easy integration. A dual Realtek chipset and 10/100/1000 Mbps Ethernet ports are also provided to deliver high-speed networking.

AIMB-216 is powered by the newest Intel® Pentium/Celeron™ processor, which is built on 14nm process technology. The thermal design power rating for the Intel N3010 dual-core architecture is only 4 W, and that for the quad-core N3710/N3160 design is only 6 W, allowing additional power reductions, smaller system footprint, and performance improvements to be implemented in the future. All these features are incorporated into a space-saving, power-efficient, and cost-effective Mini-ITX form factor.

## 1.2 Features

- Supports Intel® Pentium N3710 and Celeron N3160/N3010 processors
- Two 204-pin SODIMM, up to 8 GB DDR3L 1600 MHz SDRAM
- Supports 1 PCIe x1, and 1 MiniPCIe & 1 M.2 (B key) expansion ports, six serial ports, 4 USB 3.0 & 6 USB 2.0 (USB78910 is BOM optional), and two SATA III ports
- Lower total ownership costs with DC12V functionality; supports triple displays of
- DVI-D, DP (or eDP), HDMI (or LVDS)
- Onboard TPM 1.2/2.0 support (optional)
- Supports a dual-channel 6 W amplifier (optional)
- Supports embedded software APIs and utilities

## 1.3 Specifications

### 1.3.1 System

- **CPU:** Intel® Pentium N3710 and Celeron N3160/N3010
- **BIOS:** SPI 64-Mbit BIOS
- **SATA hard disk drive interface:** Two onboard SATA connectors with a data transmission rate of up to 6 Gb/s

**Note!** *M.2 storage support is only available when SATA 2 is not in use; M.2 storage and SATA2 cannot be used concurrently.*



Note!

### 1.3.2 Memory

- RAM: 2 x SO-DIMM DDR3L 1600 MHz up to 8 GB

**Note!** AIMB-216 supports 1.35 V memory only. Users must install the memory module on the DIMM1 socket first.



### 1.3.3 Input/Output

- **PCI bus:** One PCIe x1 slot, one full size MiniPCIe and one M.2 2242 & 2280 (B key) socket
- **Serial ports:** Six serial ports; COM3 comprises RS-232/422/485 and five RS-232 serial ports
- **Keyboard and PS/2 mouse connector:** Supports one standard PS/2 keyboard and one standard PS/2 mouse (onboard six-pin wafer box)
- **USB port:** Supports four USB 3.0 port with a transmission rate of up to 5Gbps and two USB 2.0 ports with transmission rates of up to 480 Mbps
- **GPIO connector:** One 8-bit general purpose input/output

**Note!** PCIe x 1 support is only available when MiniPCIe is not in use; MiniPCIe and PCIe x1 cannot be used concurrently.



### 1.3.4 Graphics

- **Controller:** Embedded Gen8, Gfx frequency 400/320/320 MHz for N3710/N3160/N3010
- **DVI-D:** Supports a display resolution of up to 3840 x 2160 @ 30 Hz
- **HDMI:** Supports a display resolution up to 3840 x 2160 @ 30 Hz, colay LVDS
- **LVDS:** Supports a display resolution of up to 1920 x 1200 @ 60 Hz, colay HDMI
- **DisplayPort:** Supports up to 3840 x 2160 @ 30 Hz, colay eDP
- **eDP:** Supports up to 3840 x 2160 @ 30 Hz, colay DP

### 1.3.5 Ethernet LAN

- Supports dual 10/100/1000 Mbps Ethernet port (s) via PCI Express x1 bus, which provides a data transmission rate of 500 MB/s
- **Controller:** LAN1: Realtek 8111G; LAN2: Realtek 8111G

### 1.3.6 Industrial Features

- **Watchdog timer:** Can generate a system reset. The watchdog timer is programmable, with each unit equal to one second or one minute (255 levels)

### 1.3.7 Mechanical and Environmental Specifications

- **Operating temperature:** 0 ~ 60 °C (32 ~ 140 °F, depending on the CPU)
- **Storage temperature:** -40 ~ 85 °C (-40 ~ 185 °F)
- **Humidity:** 5 ~ 95% non-condensing
- **Power supply voltage:** +12 V
- **Power consumption:** +12 V @ 2.01 A (Intel N3710 1.6 GHz processor/DDR3L 1600 MHz 4 GB x 2)
- **Board size:** 170 x 170 mm (6.69 x 6.69")
- **Board weight:** 0.365 kg

## 1.4 Jumpers and Connectors

The AIMB-216 motherboard is equipped with connectors for linking the board to external devices such as hard disk drives and a keyboard. The board also features several jumpers for configuring the system according to specific applications.

The function of each board jumper and connector is listed in the table below. The procedure for setting jumpers is explained in subsequent sections of this chapter. Instructions for connecting external devices to the motherboard are provided in Chapter 2.

**Table 1.1: Connector / Header List**

	<b>Description</b>	<b>Part Reference</b>
1	DC-IN adaptor connector	DCIN1
2	DisplayPort connector	DP1
3	EDP and LVDS2 panel power 3.3V/5V/ TION (optional)	12V SELEC- JEDP1
4	DVI-D connector	DVI_1
6	SATADOM power pin header	JSATAPWR1
7	Serial ATA interface connector	SATA1/2
8	CMOS battery wafer box	BAT1
9	CPU fan connector	CPUFAN1
10	USB3.0 stack connector	USB0102 & USB0304
11	SPI BIOS socket	BIOS1
12	COM1 box header	COM1
13	Watchdog timer output and OBS beep	JWDT1+JOBS1
14	RJ45(LAN1+LAN2) connector	LAN12
15	SPDIF interface pin header	SPDIF_OUT1
16	HD analog audio interface	AUDIO1
17	Front panel audio pin header	FPAUD1
18	Audio amplifier output pin header (optional)	JAMP1
19	PCI-Express x1 slot	PCIEX1_1
20	LVDS VESA, JEIDA format selection pin header	VCON1
21	LVDS panel connector	LVDS1
22	Dual port USB2.0 pin header	USB0506
23	DDR3L SO-DIMM socket	DIMM1/2
24	LVDS1 panel power3.3V/5V/12V selection	JLVDS1
25	COM6 RI# selection pin header	JSETCOM6_V1
26	LVDS Backlight inverter power connector	INV1
27	8-bit General Purpose I/O pin header	GPIO1
28	COM3 ~ COM6 box header	COM3456
29	AT/ATX Mode selection	PSON1
30	ATX Power supply(5VSB) connector	ATX_5V1
31	COM3 RS232,RS422,RS485 selection pin header	JSETCOM3
32	SATA power connector	SATA_PWR1/2
33	COM2 box header	COM2
34	System fan connector	SYSFAN1
35	Case open selection pin header	JCASEOP_SW1
36	Case open pin header	JCASE1

Table 1.1: Connector / Header List		
37	PS/2 keyboard and PS/2 mouse connector	KBMS1
38	MINIPCIE connector	MINI_PCIE1
39	M.2 B key connector	NGFF1
41	Low pin count interface header	LPC1
42	BIOS flash pin header	SPI1_1
43	RTC reset pin header	JCMOS1
45	Dual port USB2.0 pin header (optional)	USB0708 & USB0910
46	eDP connector (optional)	eDP1
47	Power LED and keyboard lock pin header	JFP3
48	Power switch/HDD LED/ SMBus/Speaker pin header	JFP1+JFP2
49	LVDS2 control signal pin header (optional)	LVDS2
50	eDP & LVDS2 Backlight inverter power connect or (optional)	INV2
51	ATX 12V power supply connector	ATX12V1
52	RS-485/RS-422 terminal resistor jumper	SW_422_1

# 1.5 Board Layout: Jumper and Connector Locations

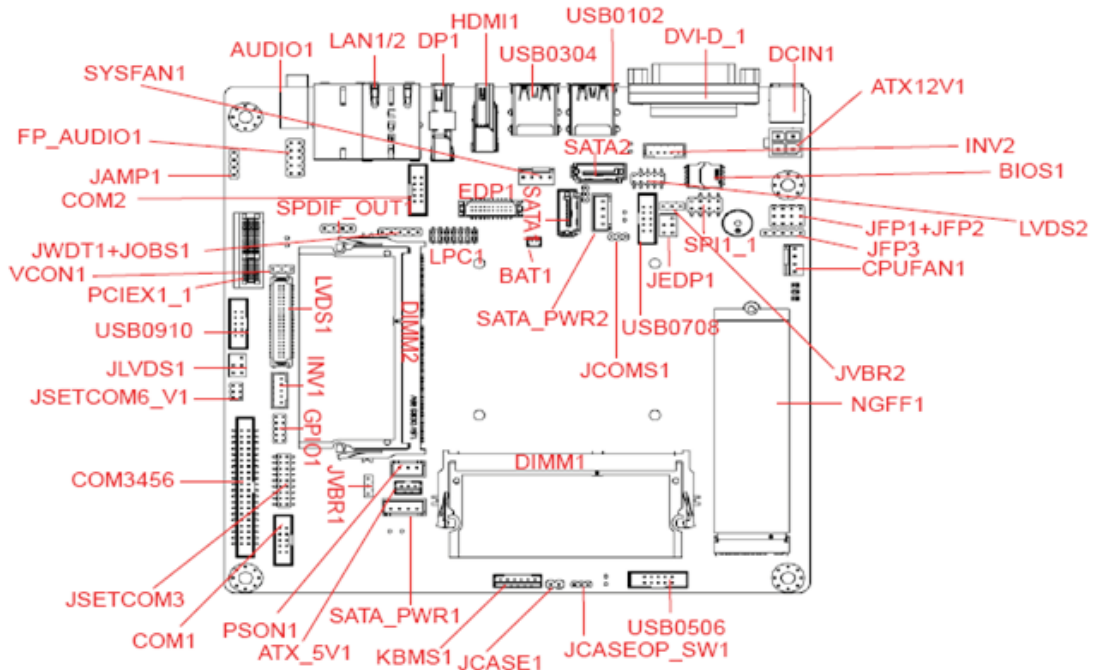

Figure 1.1 Jumper and Connector Locations

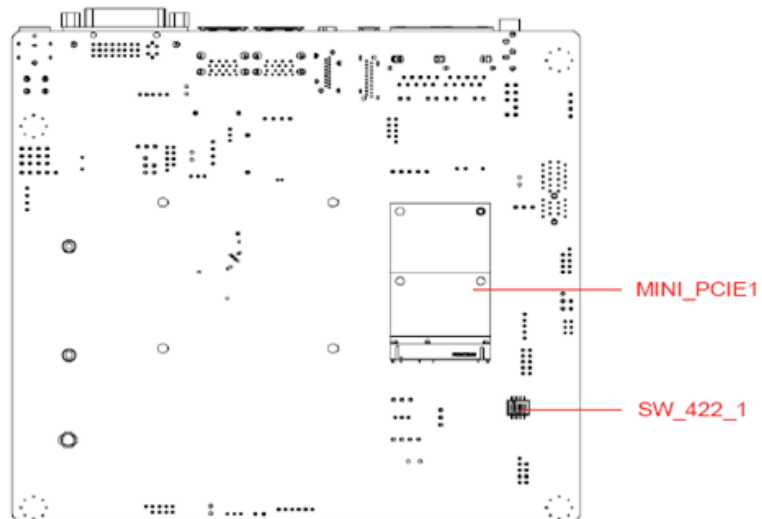

Figure 1.2 I/O Connectors

## 1.6 AIMB-216 Board Diagram

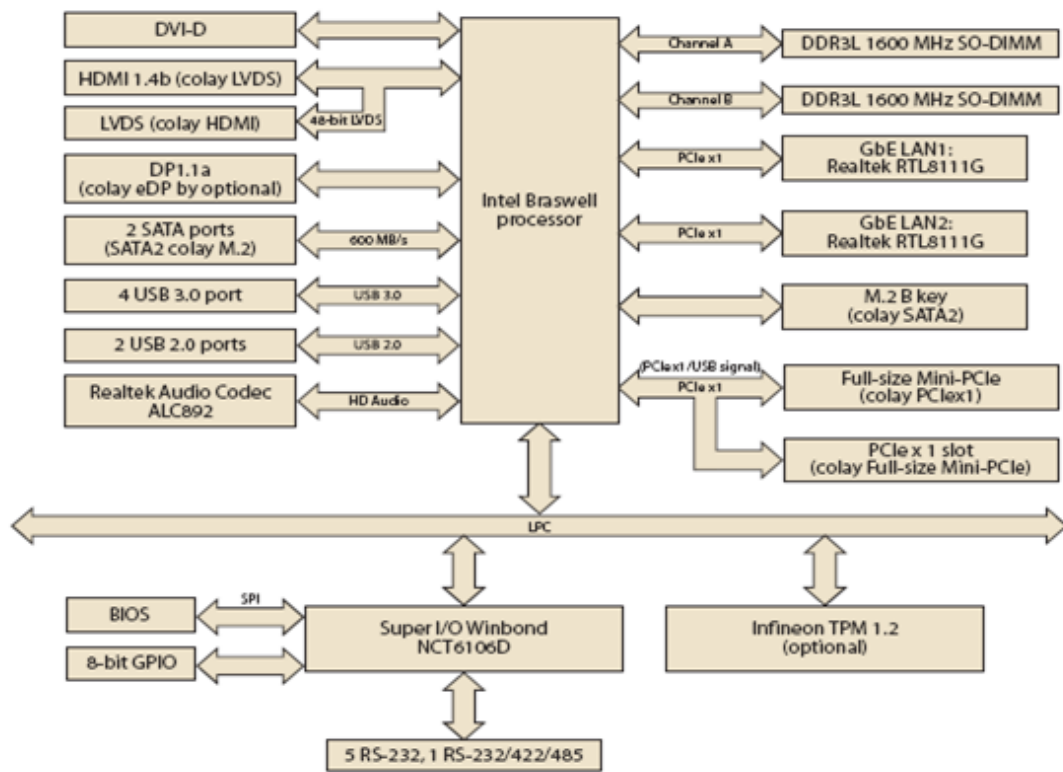

Figure 1.3 AIMB-216 Board Diagram

---

## 1.7 Safety Precautions

**Warning!** *Always completely disconnect the power cord from the chassis when working with the hardware. Do not connect devices while the power is on. Sensitive electronic components can be damaged by sudden power surges. Only experienced electronics personnel should open the PC chassis.*



**Caution!** *Always ground yourself to remove any static charge before touching the motherboard. Modern electronic devices are very sensitive to electrostatic discharges. As a safety precaution, use a grounding wrist strap at all times. Place all electronic components on a static-dissipative surface or in a static-shielded bag when not in the chassis.*



**Caution!** *The computer is provided with a battery-powered real-time clock circuit. There is a danger of explosion if the battery is incorrectly replaced. Replace only with the same or equivalent type recommended by the manufacturer. Discard used batteries according to the manufacturer's instructions.*



**Caution!** *There is a danger of a new battery exploding if incorrectly installed. Do not attempt to recharge, force open, or heat the battery. Replace the battery only with the same or equivalent type recommended by the manufacturer. Discard used batteries according to the manufacturer's instructions.*





## 1.8 Jumper Options

This section provides instructions on how to configure the motherboard by setting jumpers, and also outlines the default motherboard settings and options for each jumper.

### 1.8.1 Setting Jumpers

The motherboard can be configured according to the application requirements with the setting of jumpers. A jumper is a metal bridge used to close an electrical circuit. Jumpers typically consist of two metal pins and a small metal clip (often protected by a plastic cover) that slides over the pins to connect them. To “close” (or turn ON) a jumper, connect the pins with the clip. To “open” (or turn OFF) a jumper, simply remove the clip. Some jumpers comprise a set of three pins, labeled 1, 2, and 3. With these jumpers, simply connect either Pins 1 and 2, or Pins 2 and 3. A pair of needle-nose pliers may be necessary for setting jumpers.

### 1.8.2 CMOS Mode Selection (JCMOS1)

The AIMB-216 motherboard contains a jumper that can erase CMOS data and reset the system BIOS information. This jumper is typically set with Pins 1 and 2 being closed. To reset the CMOS data, set J1 to Pins 2 and 3 as closed for a few seconds before moving the jumper back to Pins 1 and 2 as closed. This procedure resets the CMOS to its default settings.

**Table 1.2: CMOS Mode Selection (JCMOS1)**

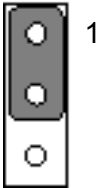
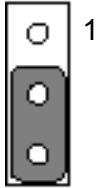
Function	Setting
Normal (Default)	
Clear CMOS	

### 1.8.3 COM3 RS-232/422/485 Mode Selector (JSETCOM3)

Users can select between the RS-232/422/485 modes for COM3 using JSETCOM3. The default setting is “RS-232”.

**Table 1.3: COM3 RS-232/422/485 (JSETCOM3)**

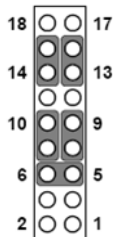
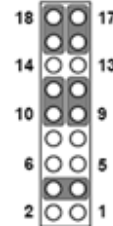
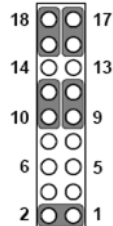
Function	Setting
Set COM3 as RS-232 (default)	
Set COM3 as RS-422	
Set COM3 as RS-485	

**Table 1.4: COM3 RS-232/422/485 (JSETCOM3)**

Function	Jumper Settings
RS-232*	(5-6) + (7-9) + (8-10) + (13-15) + (14-16) closed
RS-422	(3-4) + (9-11) + (10-12) + (15-17) + (16-18) closed
RS-485	(1-2) + (9-11) + (10-12) + (15-17) + (16-18) closed
*default	

## 1.8.4 LVDS Panel Voltage Selection (JLVDS1)

**Table 1.5: LVDS Panel Voltage Selection (JLVDS1)**

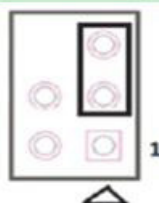
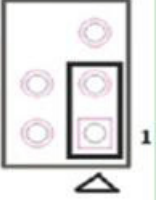
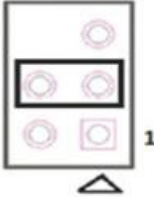
Function	Settings
Set the LVDS panel as +5 V (3-5)	
Set LVDS panel as +3.3 V (default) (1-3)	
Set the LVDS panel as +12 V (3-4)	

## 1.8.5 PSON1: ATX and AT Mode Selector

**Table 1.6: PSON1: ATX and AT Mode Selector**

Closed Pins	Result
1-2	AT Mode
2-3*	ATX Mode

\*Default

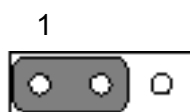

AT Mode  
1-2 closed

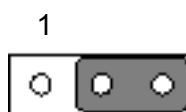

ATX Mode  
2-3 closed

## 1.8.6 JWDT1 + JOBS1: Watchdog Timer Output and OBS Beep

**Table 1.7: JWDT1 + JOBS1: Watchdog Output & OBS Beep**

Closed Pins	Result
2-3*	Watchdog reset
4-5*	OBS alarm

\*default

Function	Settings
Watchdog Timer Output (2-3) (default) OBS BEEP (4-5) (default)	
Watchdog Timer disabled (1-2) OBS BEEP (4-5) (default)	

## 1.8.7 Case Open Pin Header Selection (JCASEOP\_SW1)

**Table 1.8: Case Open Pin Header (JCASEOP\_SW1)**

Function	Settings
Normal Close	
Normal Open (default)	

## 1.8.8 Power Switch/HDD LED/SMBus/Speaker (JFP1 + JFP2)

**Table 1.9: Power Switch/HDD LED/SMBus/Speaker (JFP1 + JFP2)**

Function	Settings
JFP1 (7-10) (default)	
PWR_BTN	
HDD_LED	
SPEAKER	

### 1.8.9 EDP Panel Voltage Selection (JEDP1) (Optional)

**Table 1.10: EDP Panel Voltage Selection (JEDP1) (Optional)**

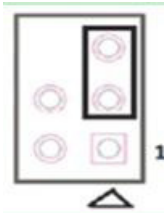
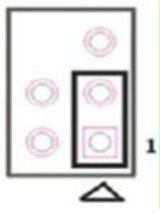
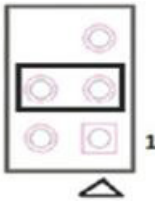
Function	Settings
Set the EDP panel as +5 V (3-5)	
Set the EDP panel as +3.3 V (default) (1-3)	
Set the EDP panel as +12 V (3-4)	

### 1.8.10 JEIDA/VESA Selection (VCON1)

**Table 1.11: JEIDA/VESA Selection (VCON1)**

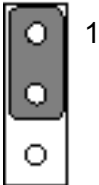
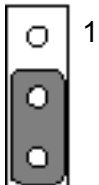
Function	Settings
Pull high to +3.3V (default) (JEIDA or VESA base on panel definition)	
Pull down to GND (JEIDA or VESA base on panel definition)	

### 1.8.11 RS-485/422 Terminal Resistor Jumper (SW\_422\_1)

**Table 1.12: RS-485/422 Terminal Resistor (SW\_422\_1)**

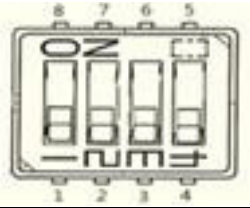
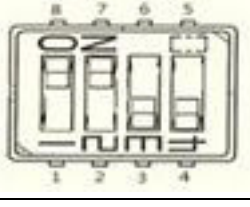
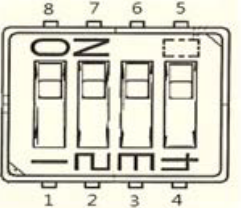
Function	Settings
Default	
Add RS-485 terminator	
Add RS-422 terminator	

### 1.8.12 COM6 5V/12V selection (JSETCOM6\_V1)

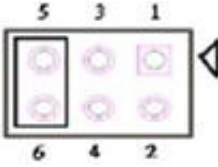
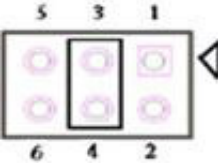
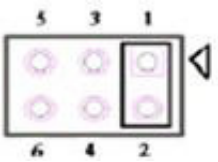

**Table 1.13: COM6 5V/12V selection (JSETCOM6\_V1)**

**Table 1.14:**

Function	Settings
Set COM6_RI# as Ring (Default)	
Set COM6_RI# as 5V	
Set COM6_RI# as 12V	



### 1.8.13 LVDS1 backlight control (JVBR1)

**Table 1.15: LVDS1 backlight control (JVBR1)**

Function	Setting
DC mode (1-2)	 1
PWM mode (2-3) (Default)	 1



### 1.8.14 eDP and LVDS2 backlight control (JVBR2)

**Table 1.16: LVDS1 backlight control (JVBR2)**

Function	Setting
DC mode (1-2)	 1
PWM mode (2-3) (Default)	 1

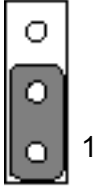

### 1.8.15 For SATA1 to support SATA DOM (JSATAPWR1)

**Table 1.17: For SATA1 to support SATA DOM (JSATAPWR1)**

Function	Setting
5V for DOM (1-2)	
GND for normal SATA connector (2-3) (Default)	

### 1.8.16 Power LED and PS2 keyboard control (JFP3)

**Table 1.18: Power LED and PS2 keyboard control (JFP3)**

Function	Setting
1-3: For power LED (Pin1: Anode, Pin3: Cathode)	
4-5: Enable PS2 keyboard	







# Chapter 2

Connecting  
Peripherals

## 2.1 Introduction

Most of the device connectors can be accessed from the top of the board during installation in the chassis. If the system is installed with several cards or the chassis is packed, partial removal of the card may be necessary to make all connections.

## 2.2 LAN and USB Ports

AIMB-216 provides up to four USB 3.0 and six USB 2.0 ports. Four USB 3.0 are located on the rear side, and six USB 2.0 are located internally. The USB interface complies with the USB specification revision 2.0 that supports transmission rates of up to 480 Mbps, revision 3.0 that supports transmission rates of up to 5 Gbps, and is also fuse protected. Furthermore, the USB interface can be disabled in the system BIOS setup menu.

The AIMB-216 system is equipped with two high-performance 1000 Mbps Ethernet LAN adapters, both of which are supported by all major network operating systems. The RJ-45 jacks on the rear panel facilitate convenient LAN connection.

**Note!** (USB0708 & USB0910 is USB 2.0 and is BOM optional)

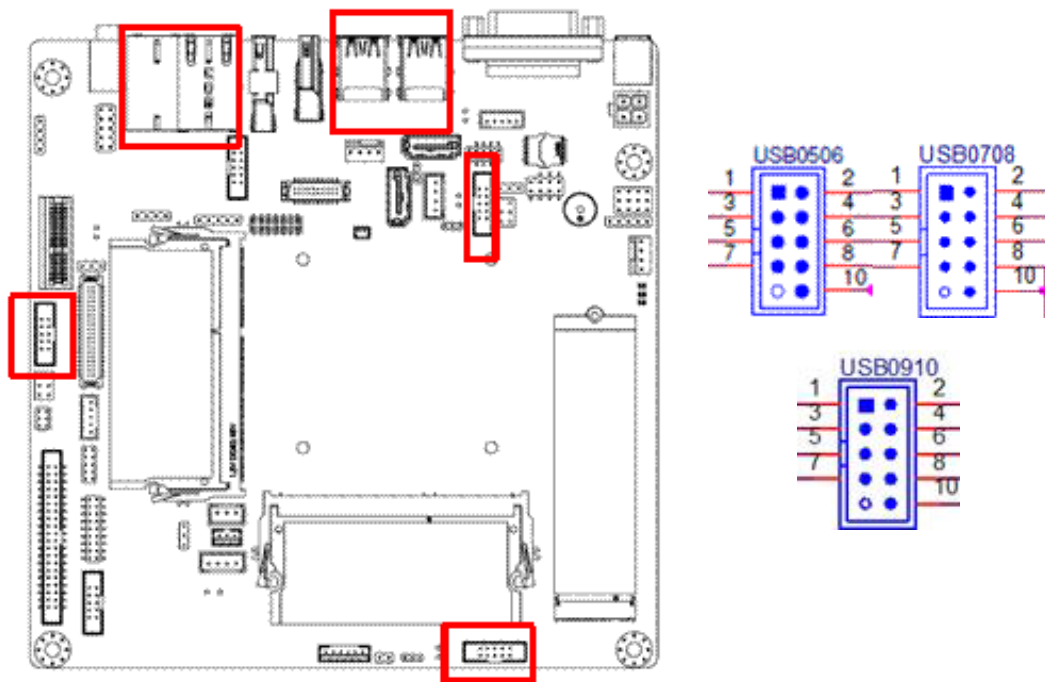

**Table 2.1: LAN LED Indicators**

LAN Mode	LAN Indicator
1 Gbps link on	LED1 Green on
100 Mbps link on	LED1 Orange on
Active	LED2 Green flashing

## 2.3 DVI-D Connector (DVI\_1)

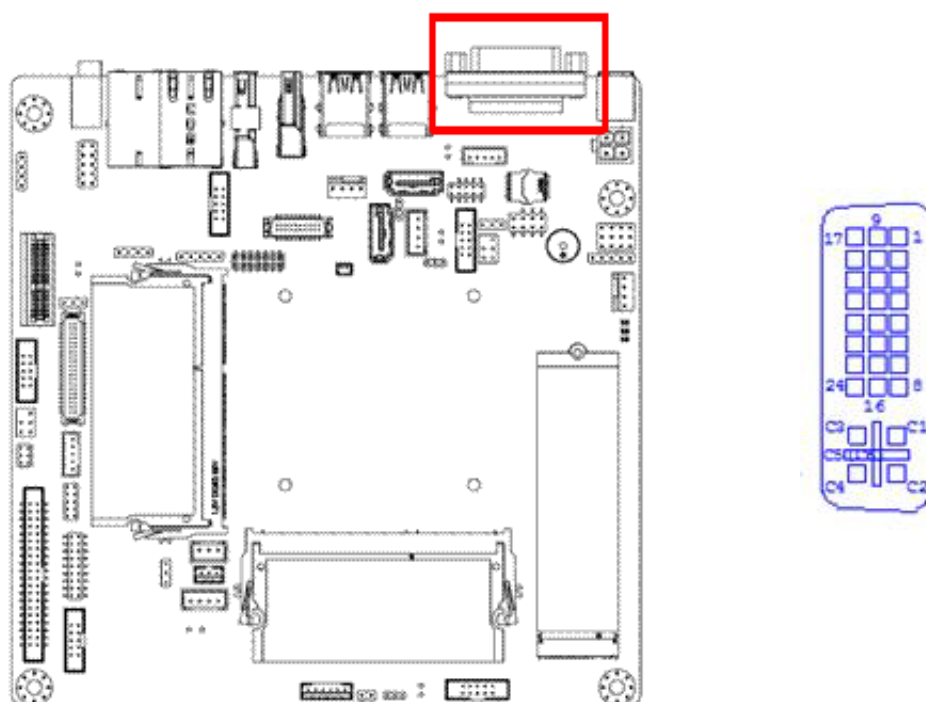

## 2.4 Serial Ports (COM1 ~ COM6)

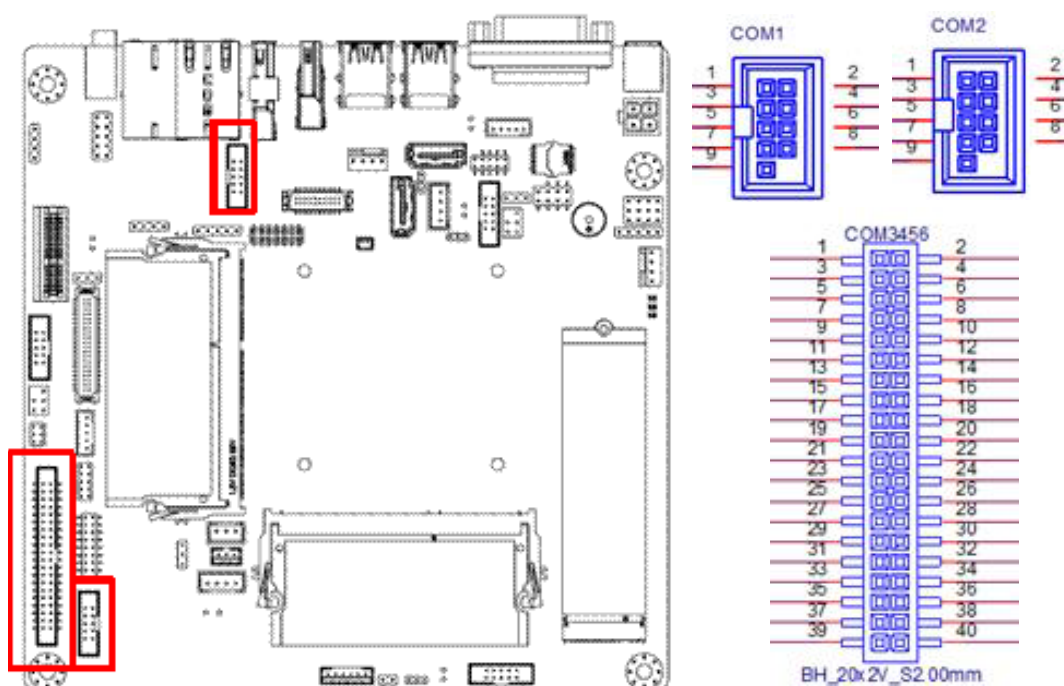

AIMB-216 supports six serial ports. COM3 is RS-232/422/485 and COM1/2/4/5/6 are RS-232. COM6 also supports 5 V/12V according to jumper selection. Users can employ JSETCOM3 to select between the RS-232/422/485 modes for COM3. Such ports can be connected to serial devices, such as a mouse or printer, or to a communications network.

The IRQ and address ranges for both ports are fixed. However, users can disable the port or change the parameters via the system BIOS setup.

Various devices implement the RS-232/422/485 standards in different manners. Users who experience problems with a serial device are advised check the connector pin assignments.

## 2.5 PS/2 Keyboard and Mouse Connector (KBMS1)

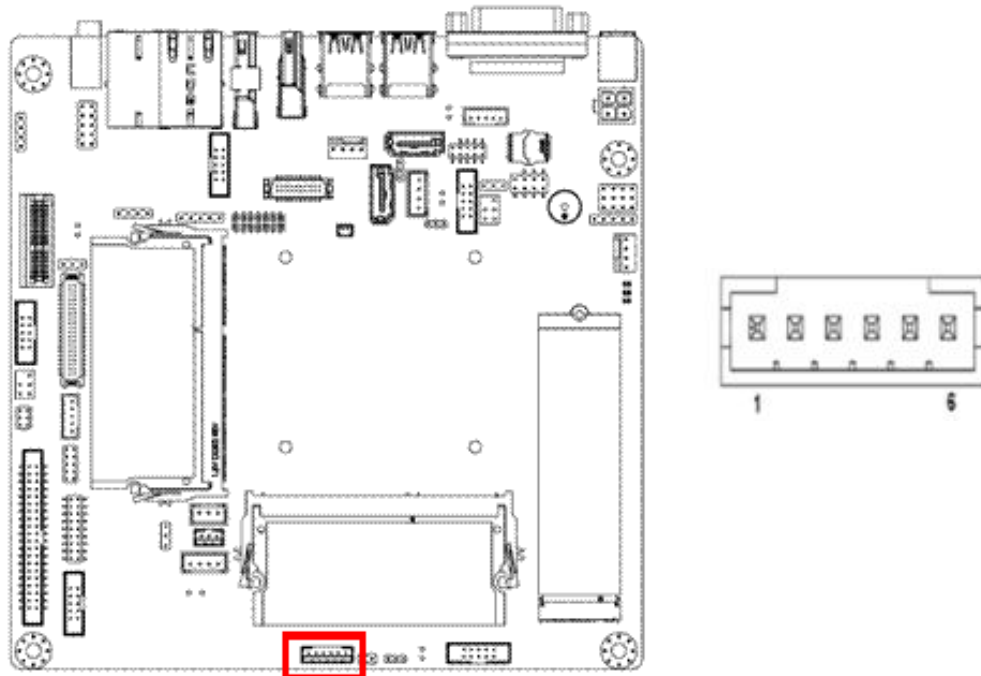

Onboard six-pin wafer box connector, which supports one standard PS/2 keyboard and one standard PS/2 mouse.

## 2.6 Display Port Connector (DP1)

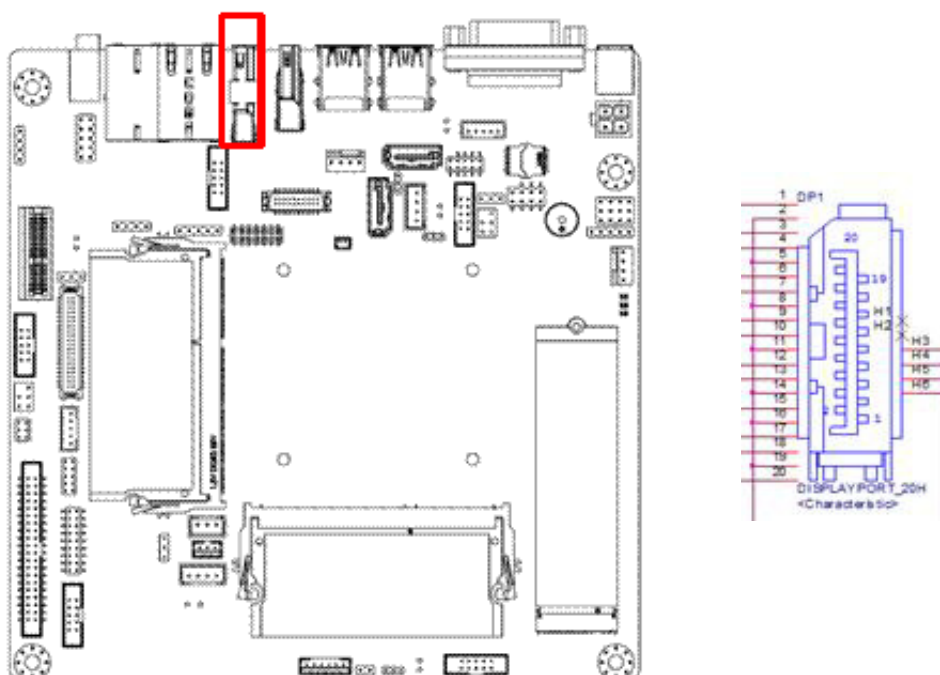

## 2.7 HDMI connector (HDMI1)

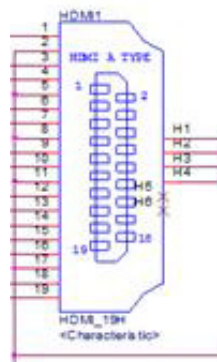
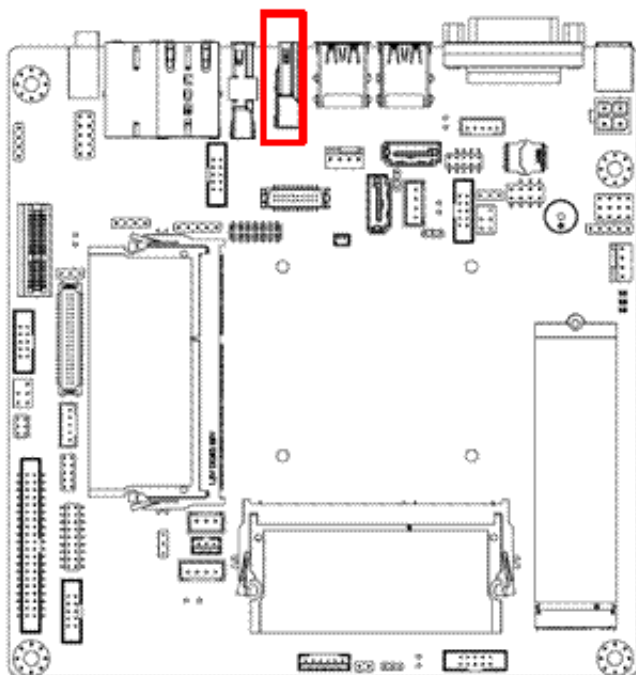

## 2.8 CPU and System FAN Connector (CPU1 and SYSFAN1)

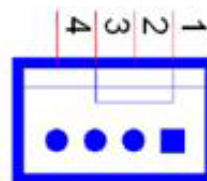
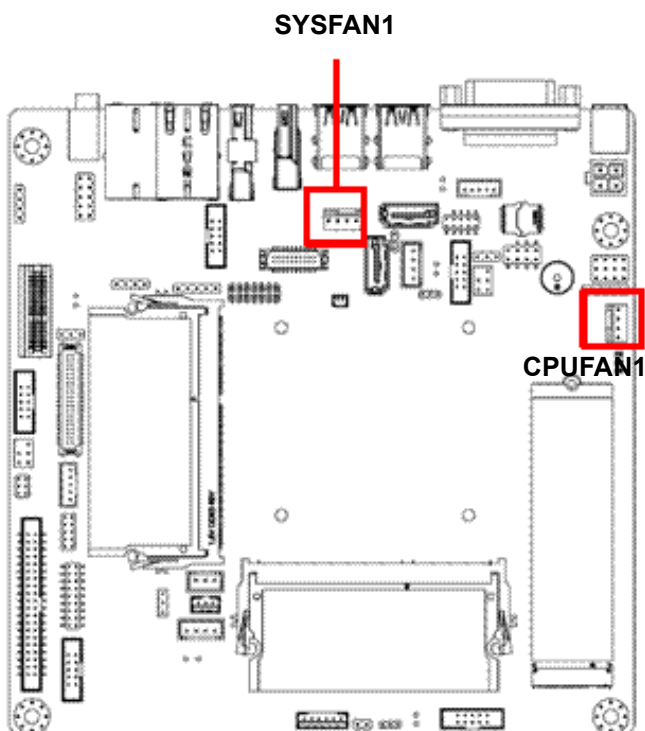

For devices with a fan installed, this connector supports cooling fans of up to 500 mA (6 W).

## 2.9 Front Panel Connectors (JFP3/JFP1 + JFP2)

Several external switches are provided for monitoring and controlling the AIMB-216.

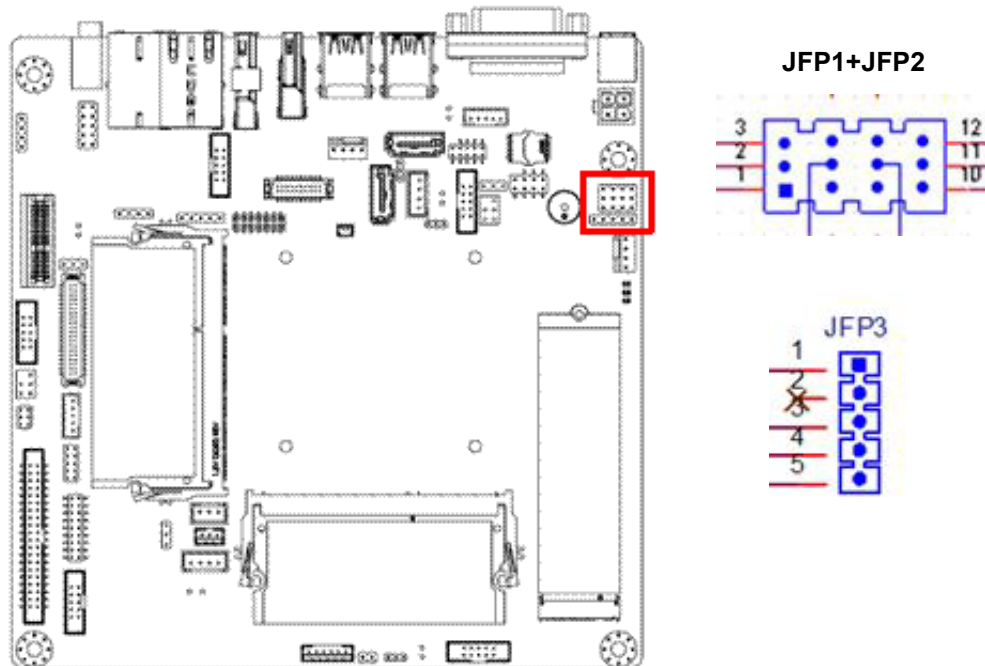

### 2.9.1 ATX Soft Power Switch (JFP1 + JFP2/PWR\_SW)

For computer cases equipped with ATX power supply, users should connect the Power On/Off button on the computer case to (JFP1 + JFP2/PWR\_SW) for convenient Power On/Off functionality.

### 2.9.2 Reset (JFP1 + JFP2/RESET)

Many computer cases offer the convenience of a specific reset button. Connect the wire for the reset button.

### 2.9.3 HDD LED (JFP1 + JFP2/HDDLED)

An LED can be linked to the connector (JFP2/HDDLED) to indicate when the HDD is active.

### 2.9.4 External Speaker (JFP1 + JFP2/SPEAKER)

(JFP1 + JFP2/SPEAKER) is a four-pin connector for an external speaker. If no external speaker is available, the AIMB-216 provides an onboard buzzer as an alternative. To enable the buzzer, set Pins 7-10 as closed.



## 2.9.5 Power LED & K/b Lock (JFP3/PWR\_LED & KEY LOCK)

(JFP3/PWR\_LED and KEY LOCK) is a five-pin connector for the Power-On LED and Key Lock function. Refer to Appendix B for detailed information regarding the pin assignments. The Power LED cable should be connected to Pins 1-3. The key lock button cable should be connected to Pins 4 and 5.

Three power supply connection modes exist. The first is the ATX power mode, where the system is powered on/off by momentarily pressing the power button. The second is the AT power mode, where the system is powered on/off using the power supply switch. The third is another AT power mode that involves the front panel power switch. The status differences indicated by the power LED are listed in the following table:

**Table 2.2: ATX PSU LED Status (AT power not supported)**

Power mode	LED (ATX power mode) (On/off by momentarily pressing the power button)	LED (AT power mode) (Powered on/off using the power supply switch)	LED (AT power mode) (Powered on/off using the front panel switch)
PSON1 (on the back plane) jumper setting	Pins 2-3 closed	Pins 1-2 closed	Connect Pins 1 and 2 to the panel switch via cable
System On	On	On	On
S3	Fast flashing	N/A	N/A
S4	Slow flashing	N/A	N/A
System Off	Off	Off	Off

## 2.10 Line-Out Connector (AUDIO1)

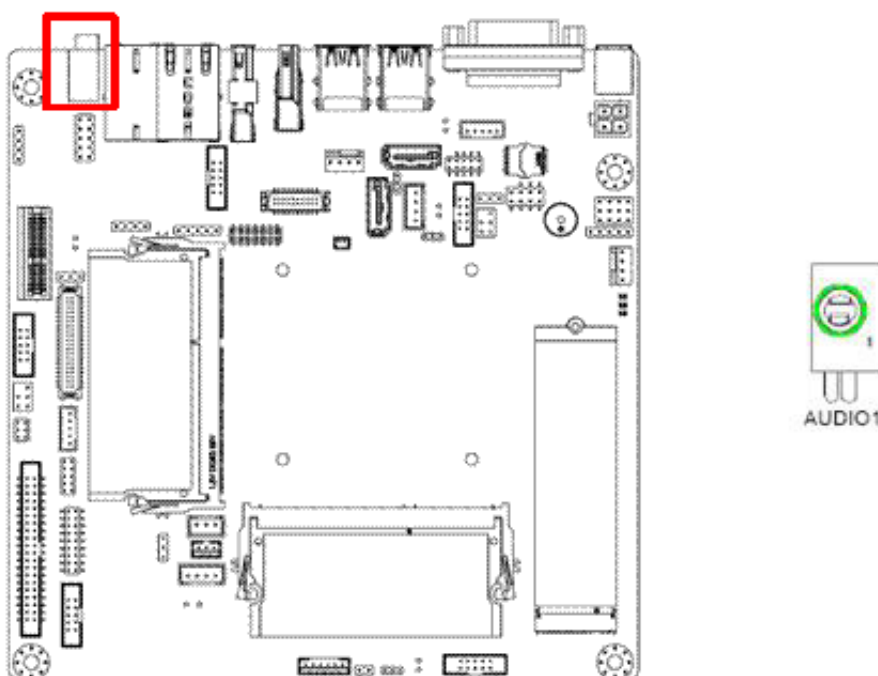

This connector supports line-out, mic-in, and line-in functions. (Default: line-out)

## 2.11 Serial ATA Interface (SATA1/2) & SATADOM Power Pin Header (JSATAPWR1)

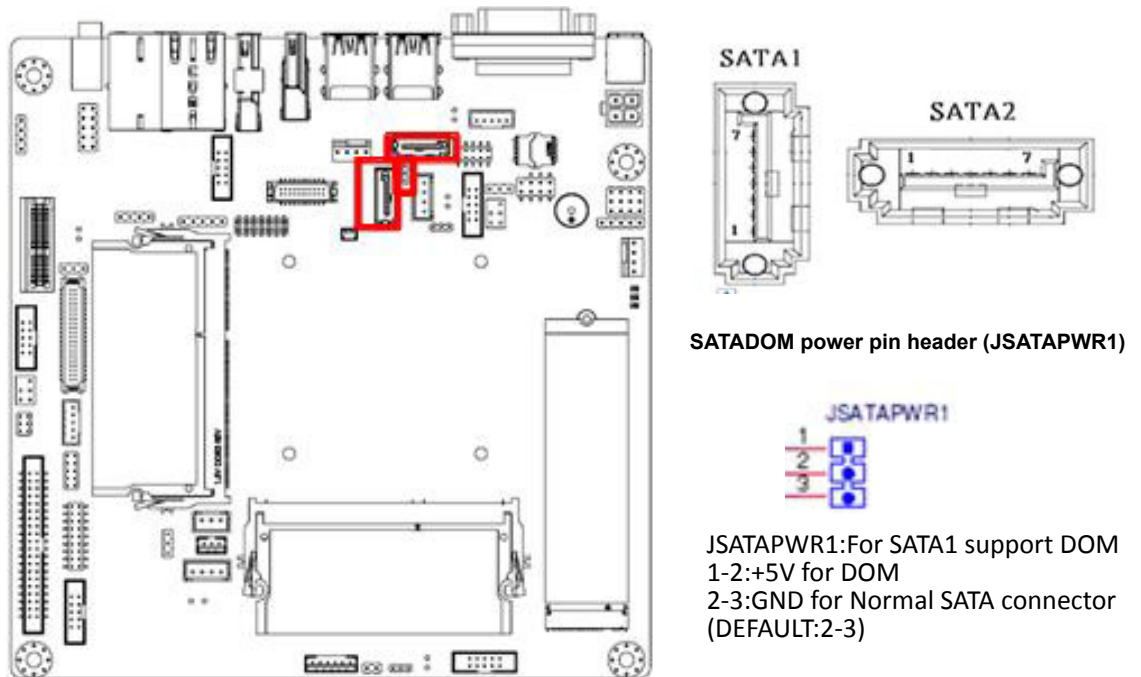

This connector supports line-out, mic-in, and line-in functions. (Default: line-out)

## 2.12 PCI-Express x1 Slot (PCIEX1\_1)

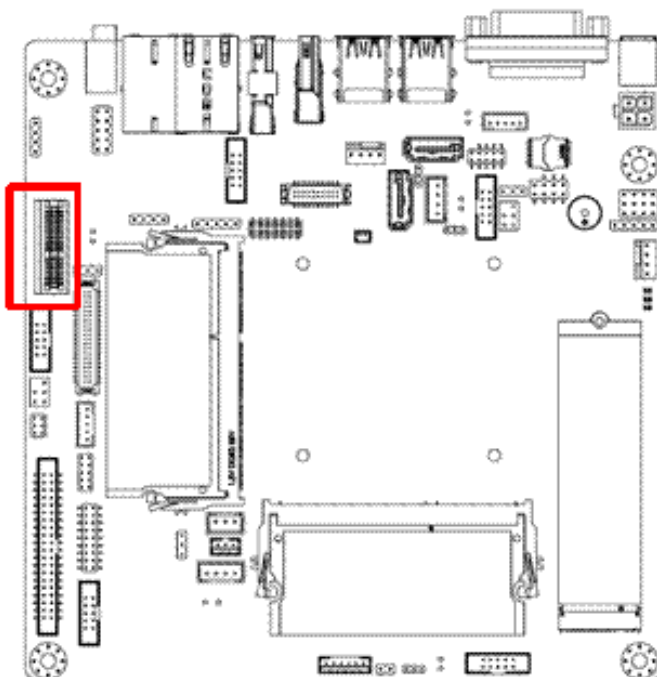

AIMB-216 features one PCIe x1 slot.

## 2.13 Front Panel Audio Connector (FP\_AUDIO1)

This connector is for a chassis-mounted front-panel audio I/O module that supports HD audio. This connector is attached using the front panel audio I/O module cable.

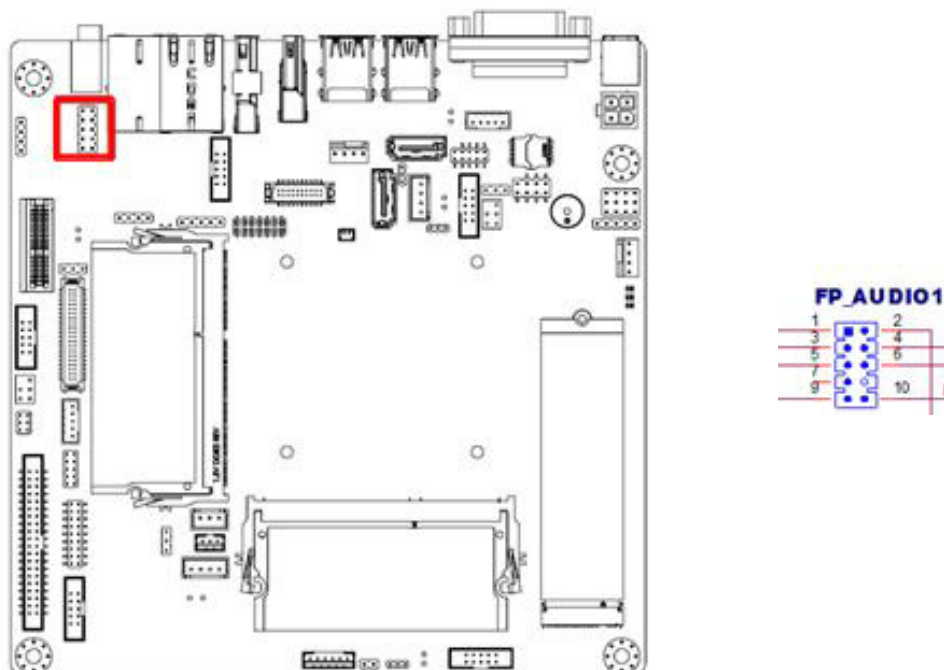

## 2.14 ATX 12V Power Connector (ATX12V1)

This connector is for an ATX Micro-Fit power supply. The plugs from the power supply are designed to fit these connectors in only one direction. Determine the correct orientation and press firmly until the connectors mate completely.

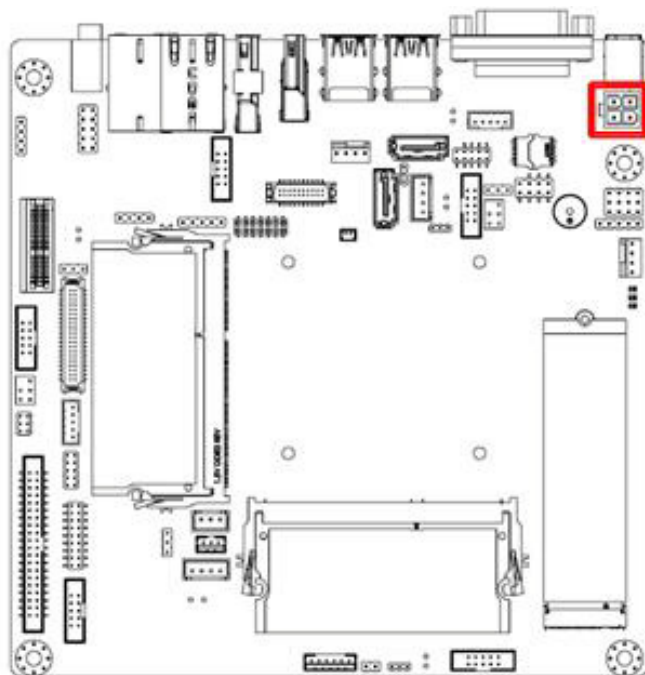

## 2.15 SPI Flash Connector(SPI1\_1)

The SPI flash card pin header may be used to flash the BIOS if the AIMB-216 cannot be powered on.

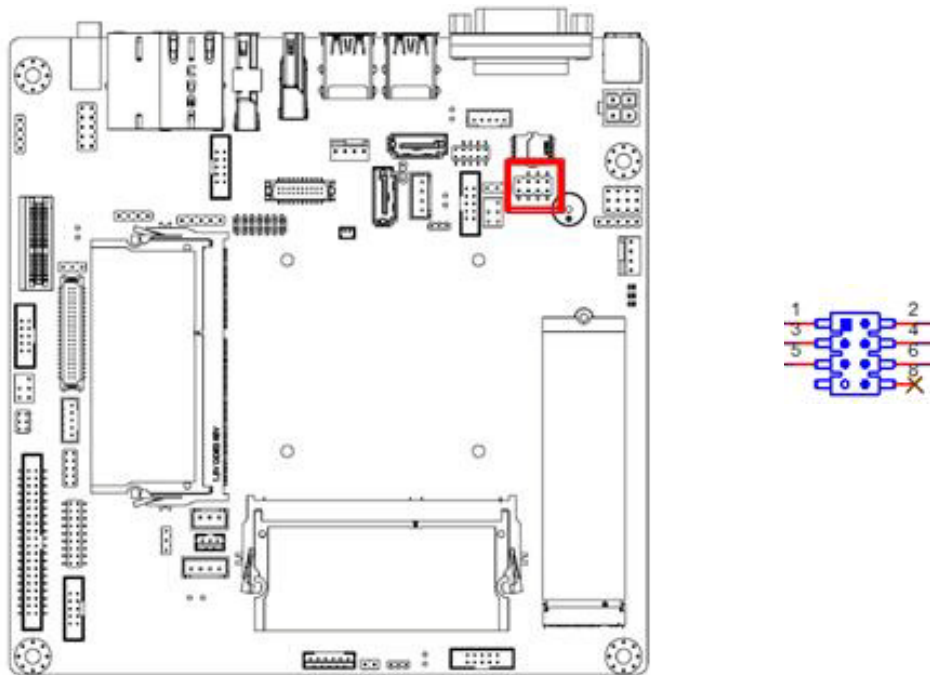

## 2.16 LVDS Backlight Inverter Power Connector (INV1)

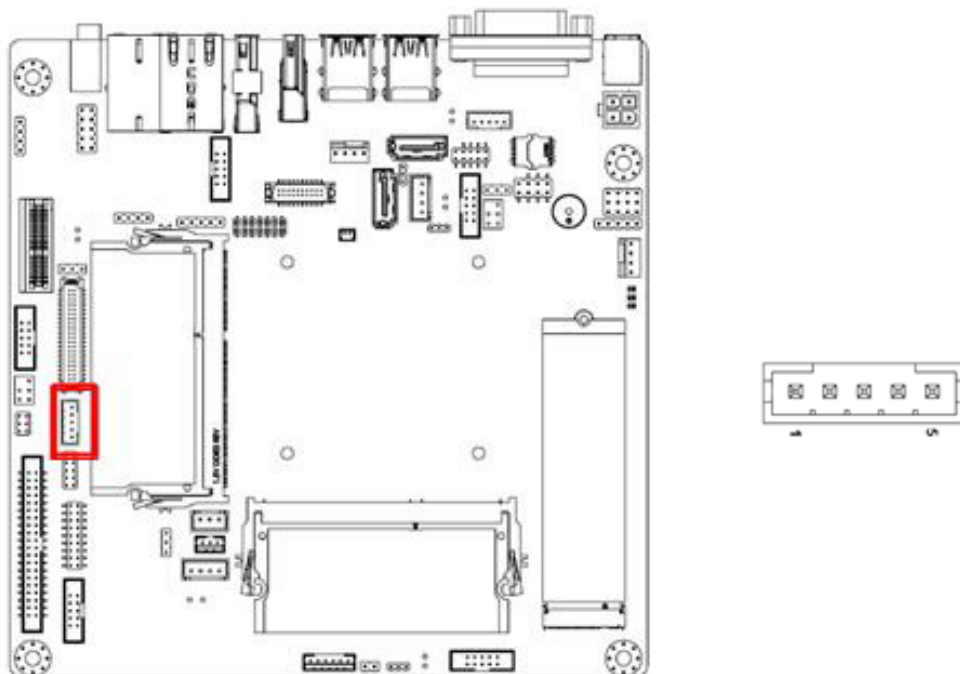

**Note!**



**Signal Description**

**Signal**  
VR  
ENBKL

**Signal Description**

**Vadj=0.75 V**  
(Recommended: 4.7 K $\Omega$ , > 1/16 W)  
LCD backlight ON/OFF control signal

## 2.17 LVDS Connector (LVDS1)

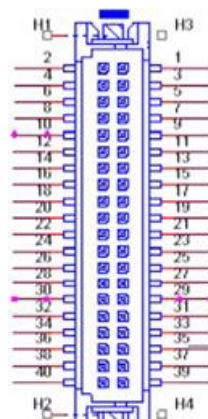
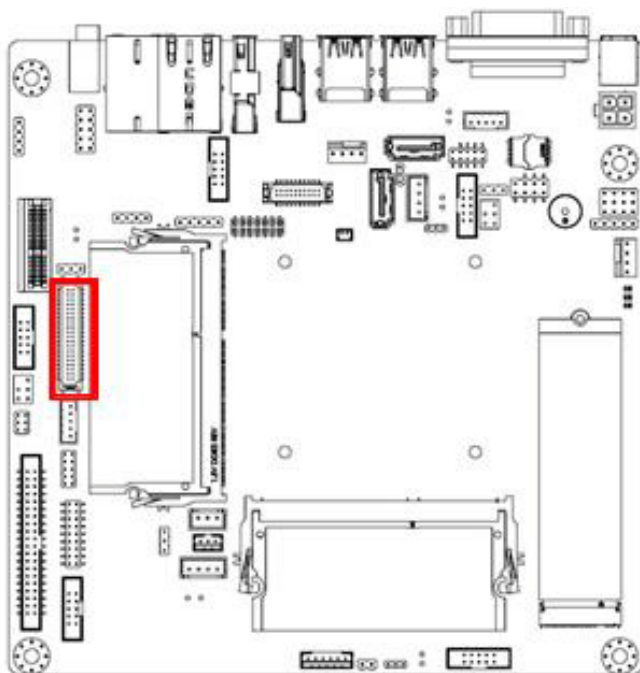

LVDS1

Pin 3: GND →  
 anel connected  
 NC/3.3V → No panel

## 2.18 General Purpose I/O Connector (GPIO1)

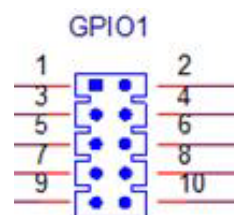
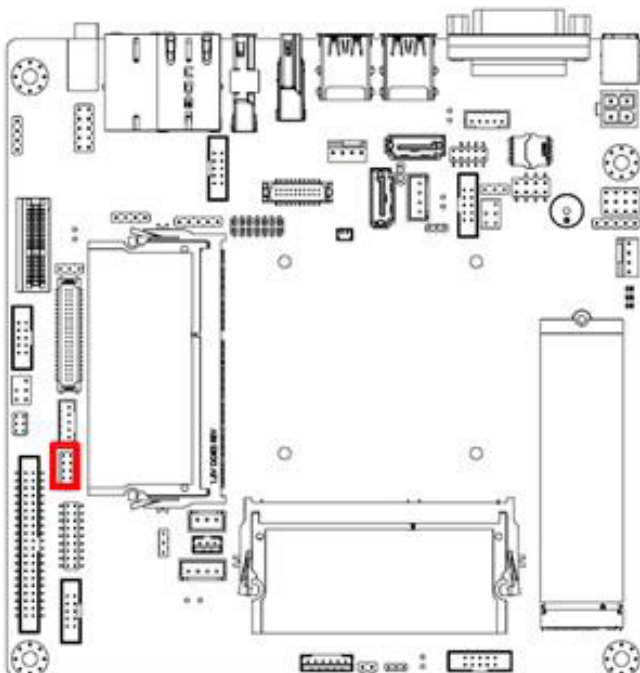

## 2.19 CMOS Battery Wafer Box (BAT1)

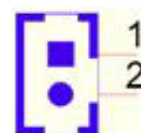

## 2.20 SPI BIOS Socket (BIOS1)

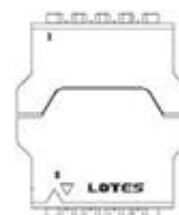
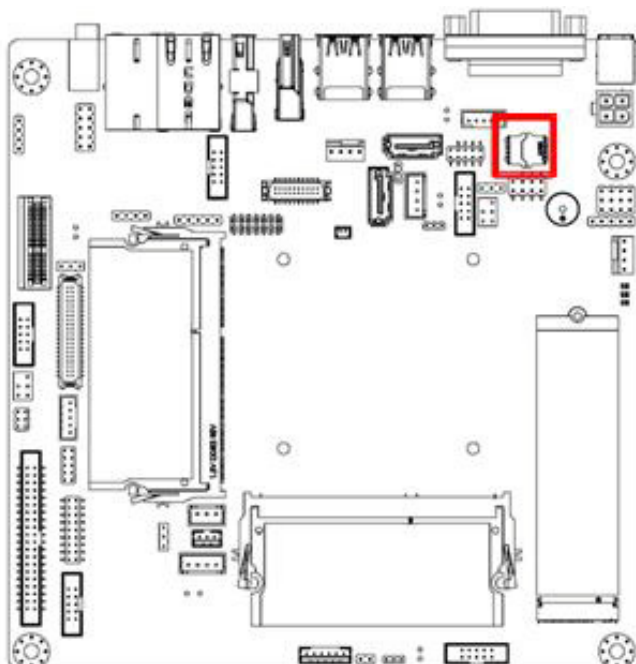



## 2.21 SPDIF Interface Pin Header (SPDIF\_OUT1)

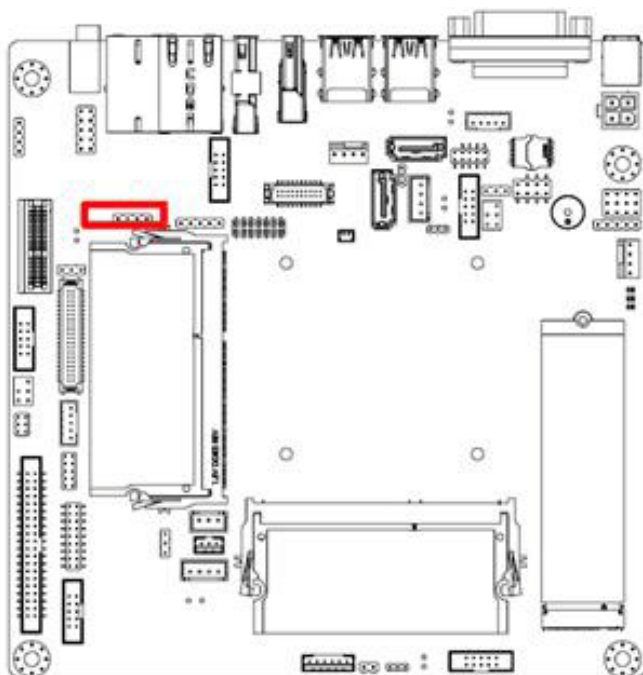

**SPDIF\_OUT1**

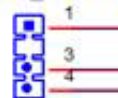

## 2.22 Audio Amplifier Output Pin Header (JAMP1) (BOM Optional)

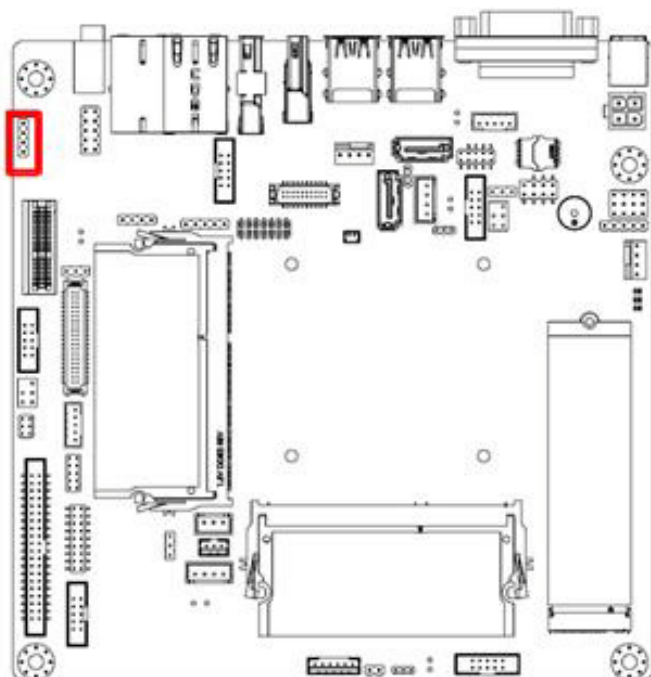

**JAMP1**

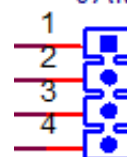

## 2.23 ATX Power Supply (5VSB) Connector (ATX\_5V1)

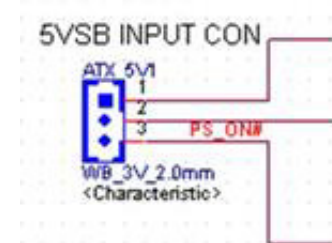
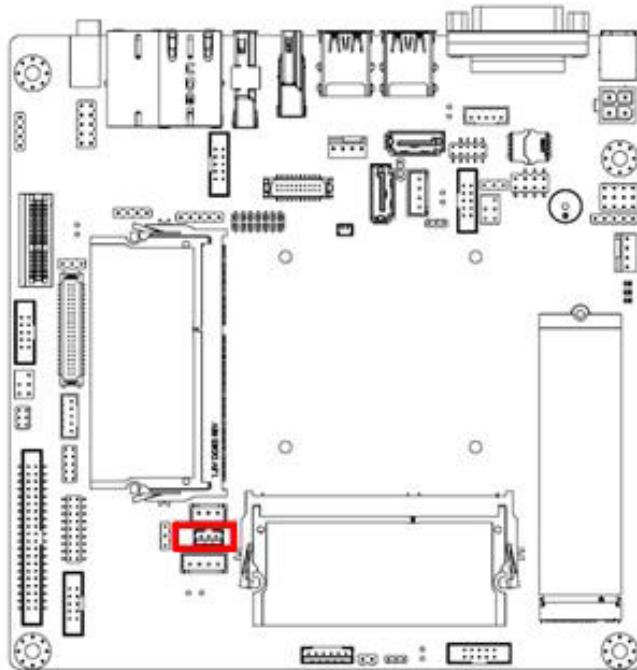

## 2.24 SATA Power Connector (SATA\_PWR1/2)

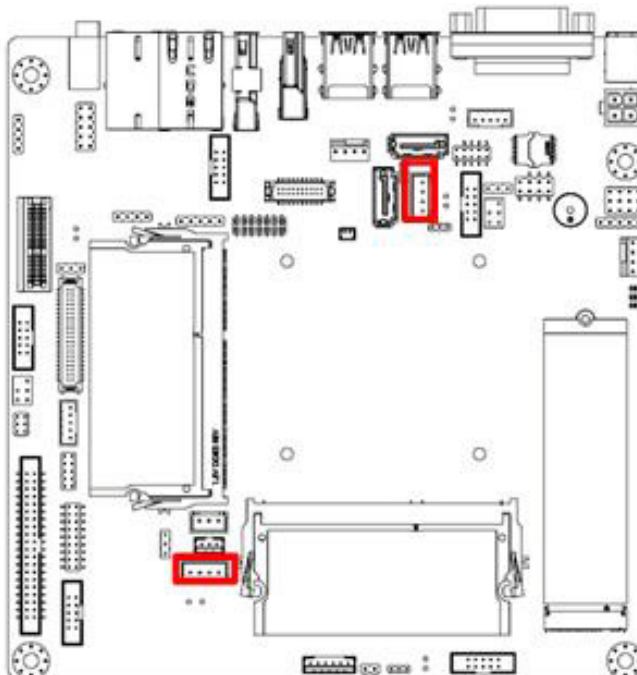



## 2.25 Case Open Pin Header (JCASE1)

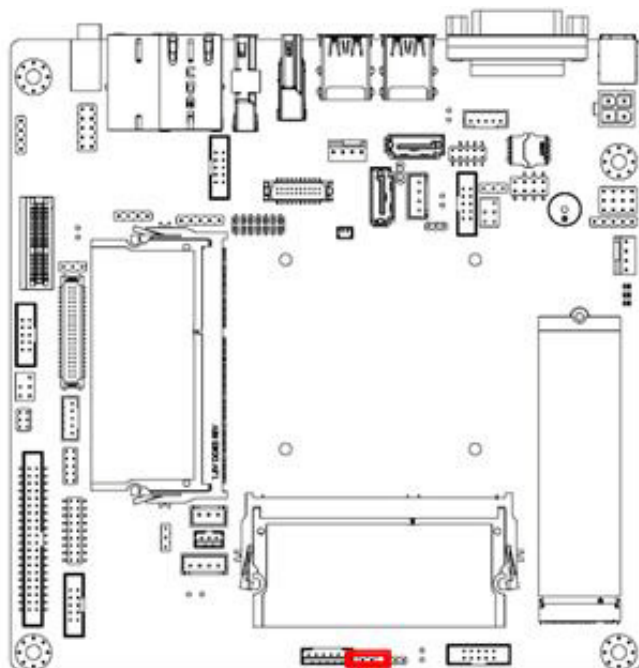

## 2.26 DDR3L SODIMM Socket (DIMM1/2)

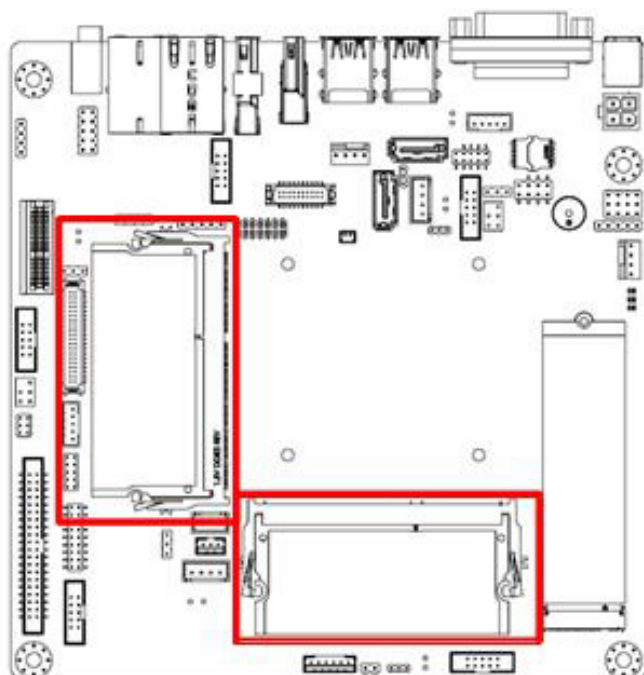

**Note!** AIMB-216 supports 1.35 V memory only. Users must populate the memory on socket DIMM1 first.



Users are advised to use memory modules of the same type, speed, and frequency for each motherboard. Memory modules of different types and speeds should not be used.

## 2.27 Mini-PCle Connector (MINIPCI-E1)

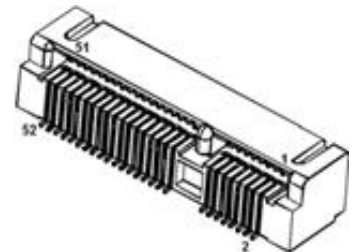
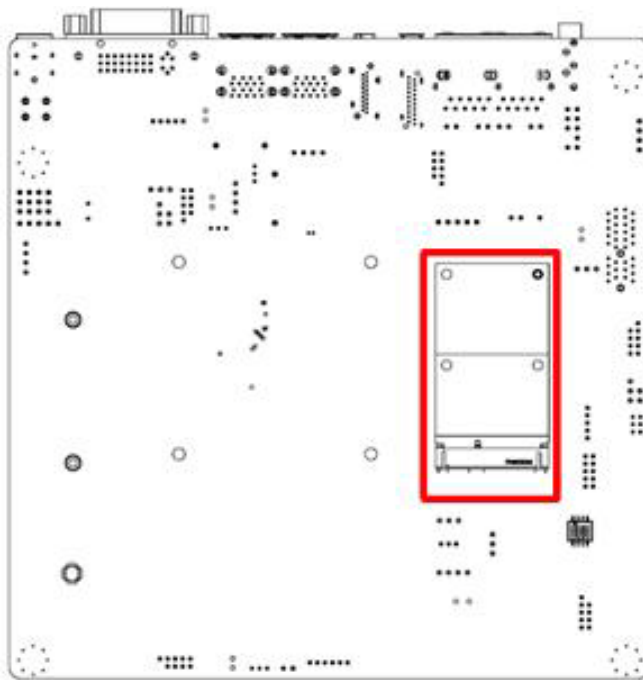

## 2.28 M.2 B Key Connector (NGFF1)

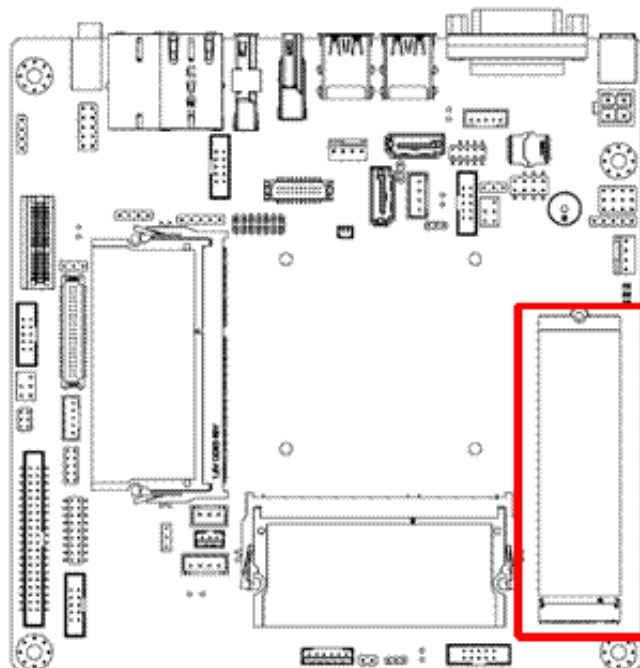

## 2.29 RTC Reset Pin Header (JCMOS1)

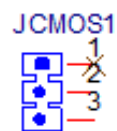
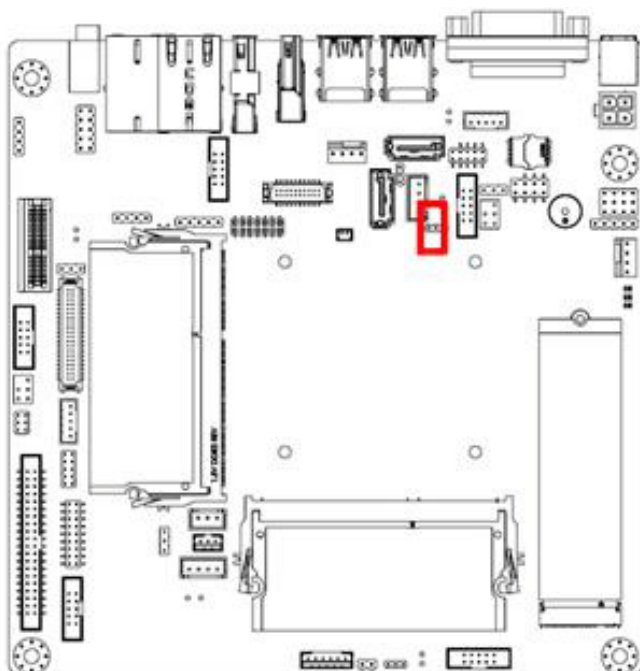

## 2.30 eDP Connector (eDP1), BOM optional

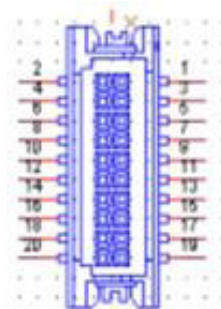
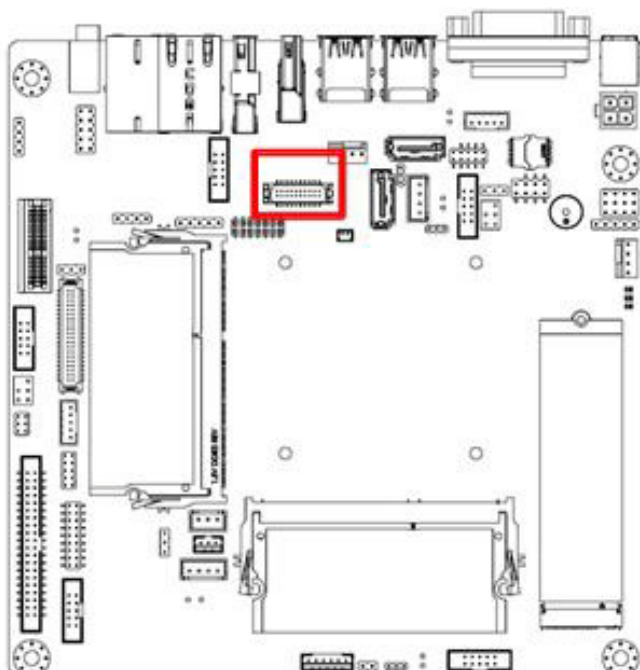

## 2.31 eDP & LVDS2 Backlight Inverter Power (INV2), (BOM option)

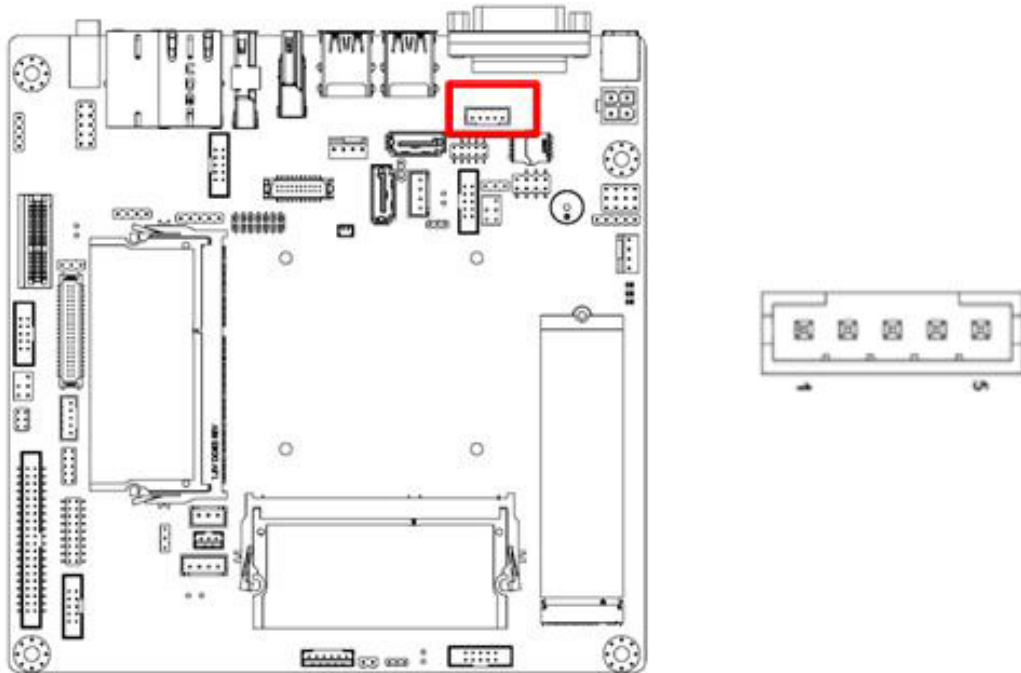

## 2.32 LVDS2 Control Signal (LVDS2), (BOM option)

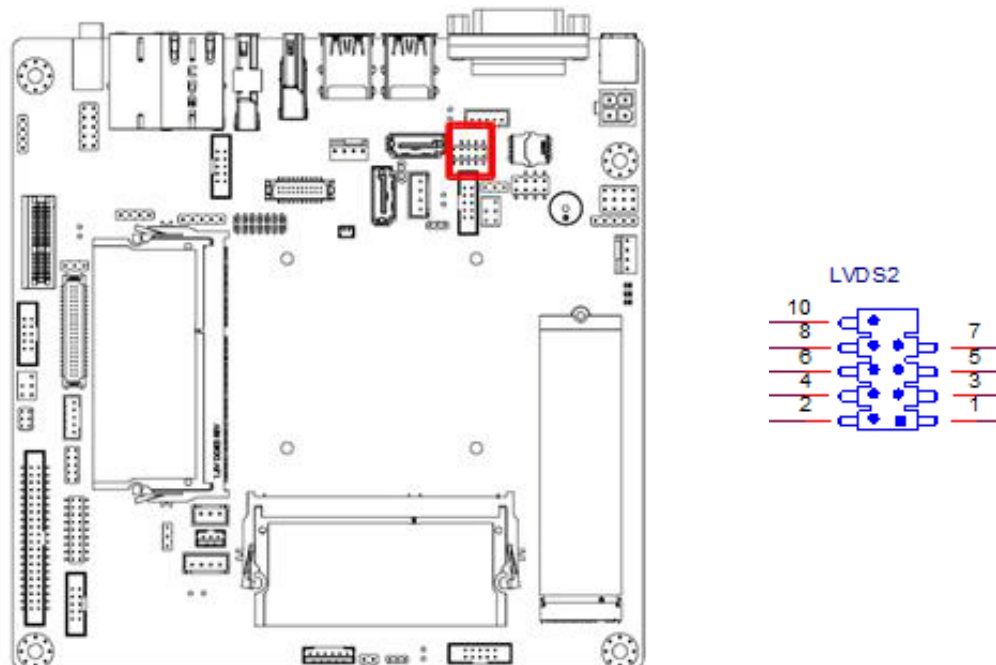

**Note!** AIMB-216 can support 2nd LVDS function via AIMB-LVDS2-00A1E. It requires customized BIOS and AIMB-216 BOM change.



# Chapter 3

BIOS Operation

## 3.1 Introduction

With the AMI BIOS Setup program, users can modify the BIOS settings and control the special system features. The Setup program comprises several menus with options for adjusting or turning special features on or off. This chapter describes the basic navigation of the AIMB-216 BIOS setup menu pages.

## 3.2 BIOS Setup

The AIMB-216 Series is equipped with built-in AMI BIOS and a CMOS Setup Utility that allows users to configure specific settings or activate certain system features.

The CMOS Setup Utility saves the configuration in the CMOS RAM of the motherboard. When the system power is turned off, the battery on the board supplies the necessary power to preserve the CMOS RAM.

When the power is turned on, press the <Del> button during the BIOS power-on self-test (POST) to access the CMOS Setup Utility screen.

---

### Control Keys

---

< ↑ >< ↓ >< ← >< → >	Move select item
<Enter>	Select item
<Esc>	Main Menu - Quit without saving changes to the CMOS Sub Menu - Exit current page and return to the Main Menu
<Page Up/+>	Increase the numeric value or make changes
<Page Down/->	Decrease the numeric value or make changes
<F1>	General help, for Setup Sub Menu
<F2>	Item help
<F5>	Load previous values
<F7>	Load setup defaults
<F10>	Save all CMOS changes

---

### 3.2.1 Main Menu

Press <Del> to enter the AMI BIOS CMOS Setup Utility, the Main Menu will appear on the screen. Use the arrow keys to select items and press <Enter> to access the submenu.



The Main BIOS setup screen has two main frames. The left frame displays all the options that can be configured. Grayed-out options cannot be configured; options in blue can. The right frame displays the key legend.

Above the key legend is an area reserved for a text message. When an option is selected in the left frame, it is highlighted in white. Often a text message will accompany it.

#### ■ System Time/System Date

Use this option to change the system time and date. Highlight the System Time or System Date using the <Arrow> keys. Enter new values via the keyboard. Press the <Tab> or <Arrow> keys to move between fields. The date must be entered in MM/DD/YY format. The time must be entered in HH:MM:SS format.

### 3.2.2 Advanced BIOS Features

Select the Advanced tab from the AIMB-216 Setup menu to enter the Advanced BIOS Setup page. Users can select any item in the left frame of the screen, such as CPU Configuration, to access the submenu for that item. Select an Advanced BIOS Setup option by highlighting the text using the <Arrow> keys. All Advanced BIOS Setup options are described in this section. The Advanced BIOS Setup menu screen is shown below. The submenus are described in the following pages.

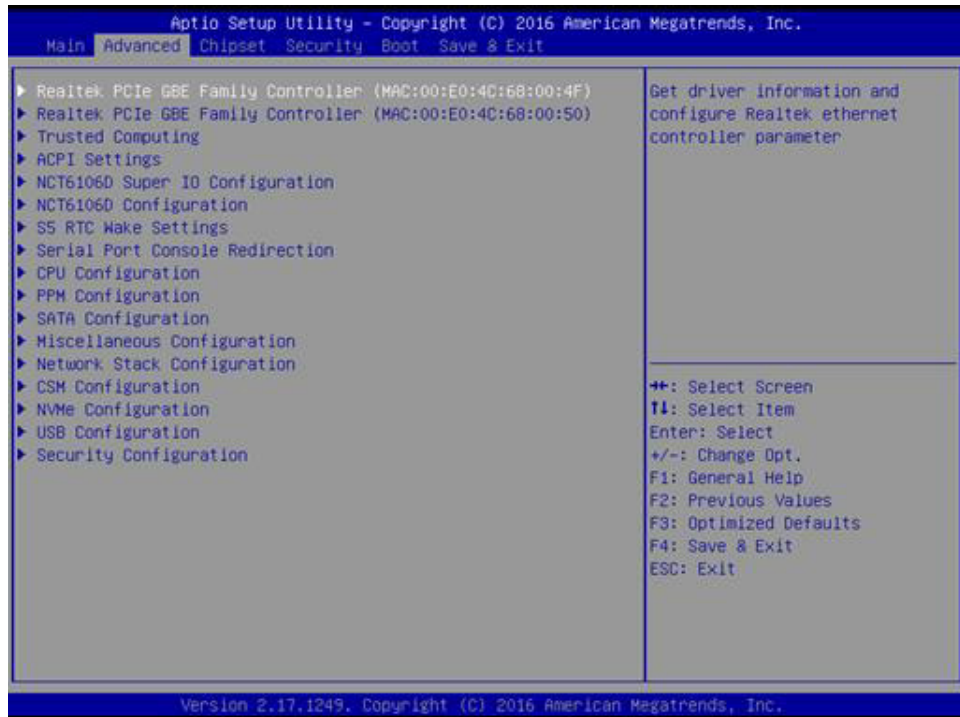



## 3.2.2.1 Realtek PCIe GBE Family Controller

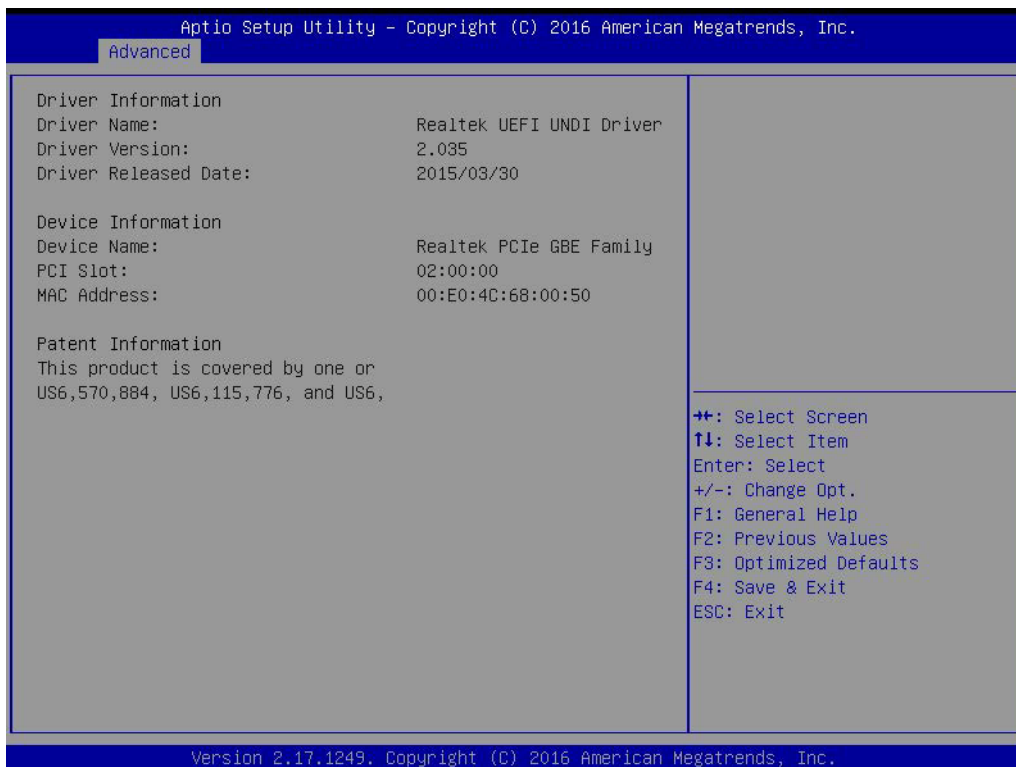
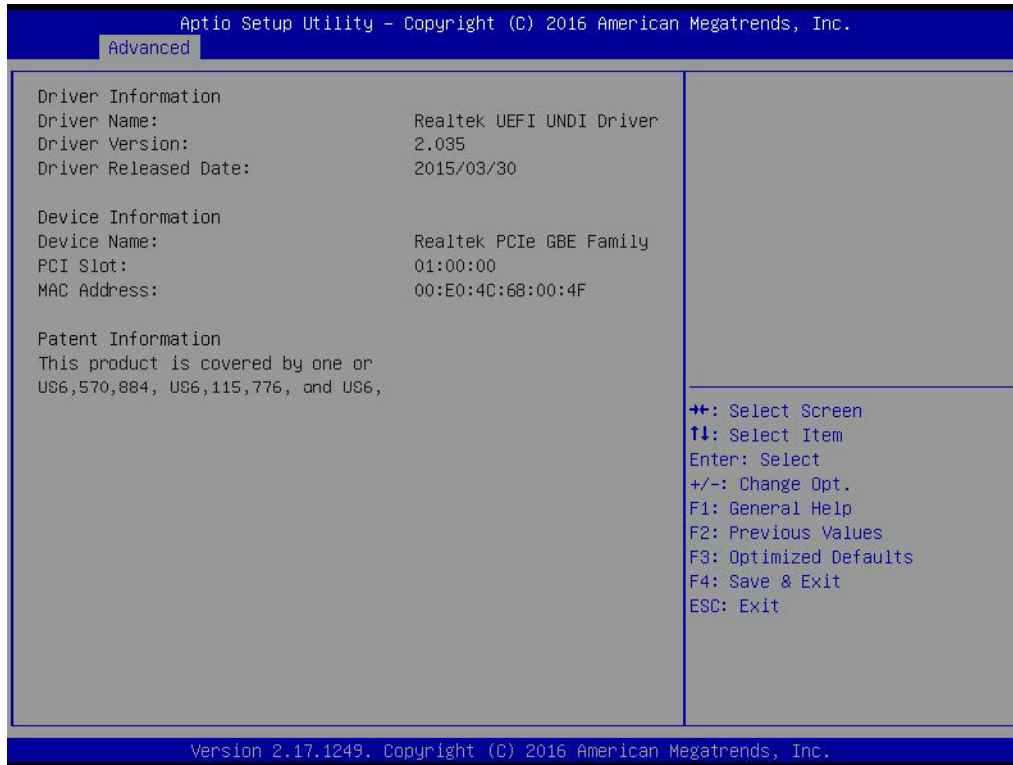

### 3.2.2.2 Trusted Computing



- **Security Device Support**  
To enable or disable BIOS support for security device support.

### 3.2.2.3 ACPI Settings



- **Enable ACPI Auto Configuration**  
Enable or Disable ACPI Auto Configuration.
- **Enable Hibernation**  
This item allows users to enable or disable hibernation.
- **ACPI Sleep State**  
This item allows users to set the ACPI sleep state.
- **Lock Legacy Resources**  
This item allows users to lock legacy device resources.

### 3.2.2.4 Super IO Configuration

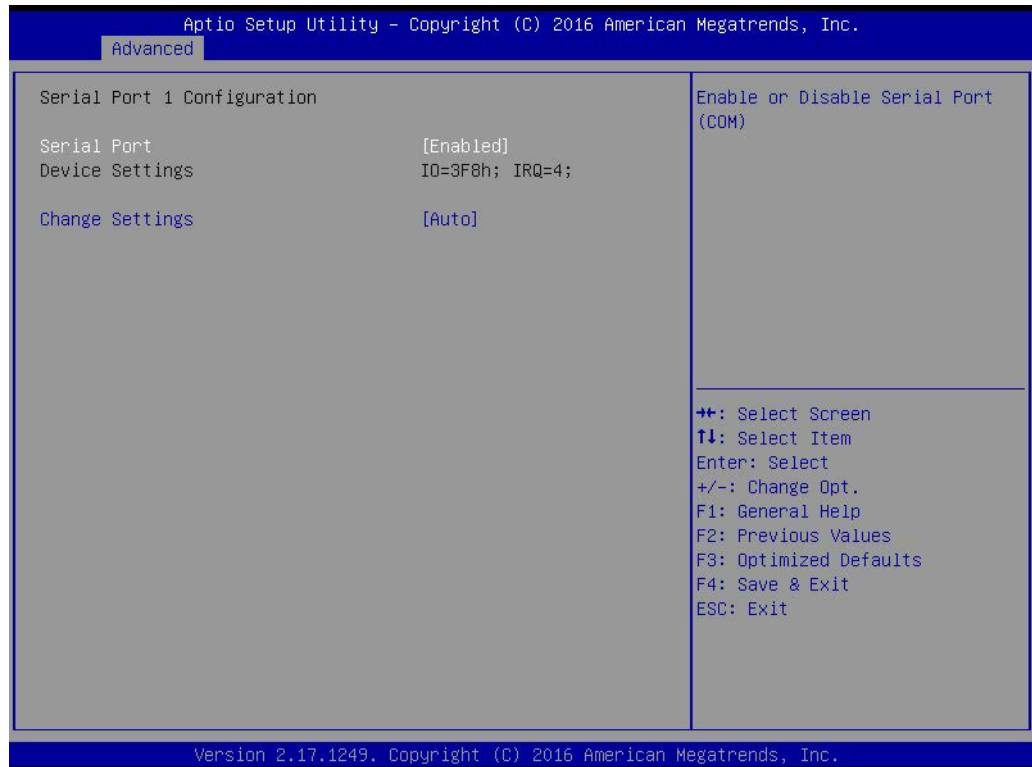
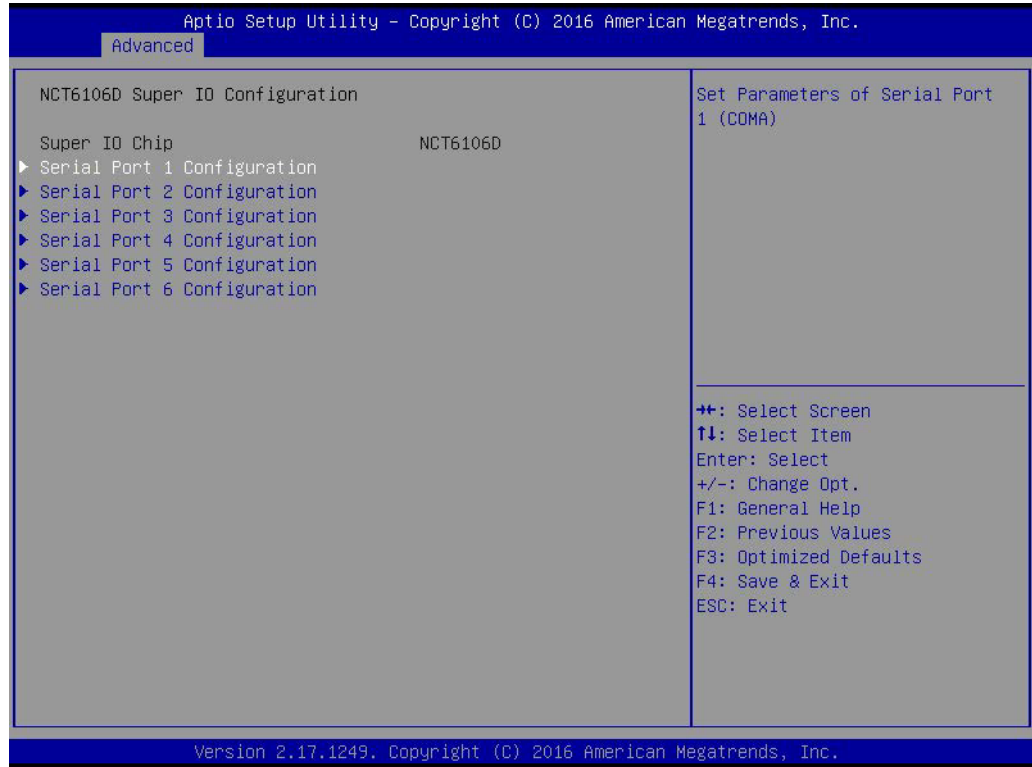

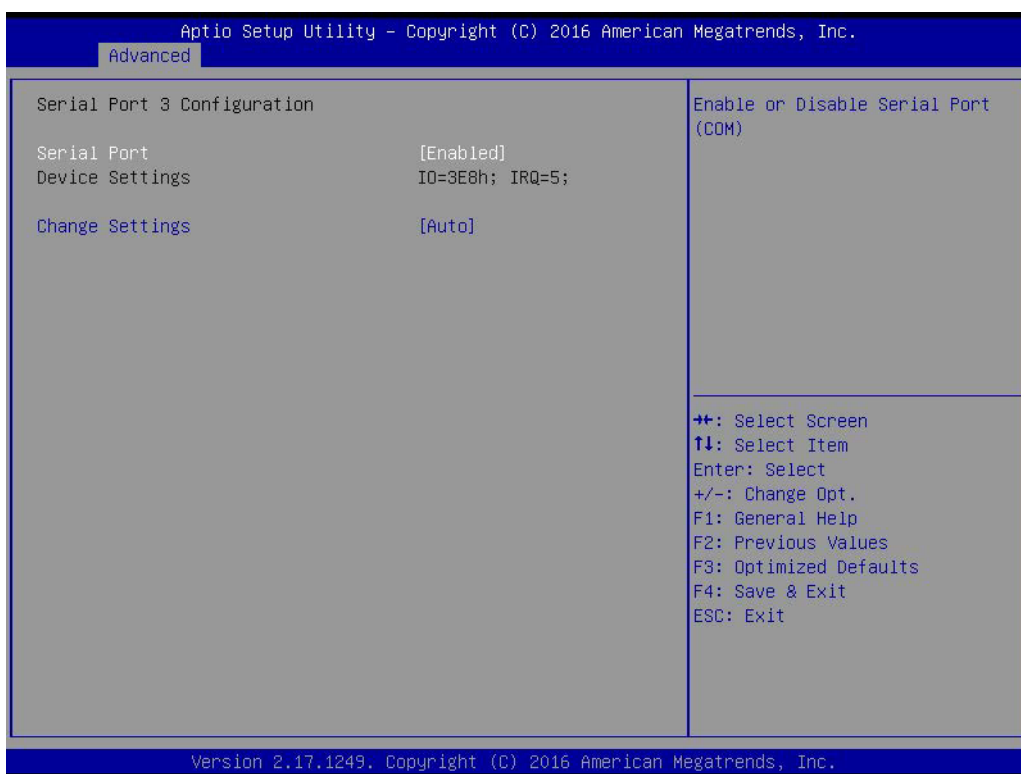
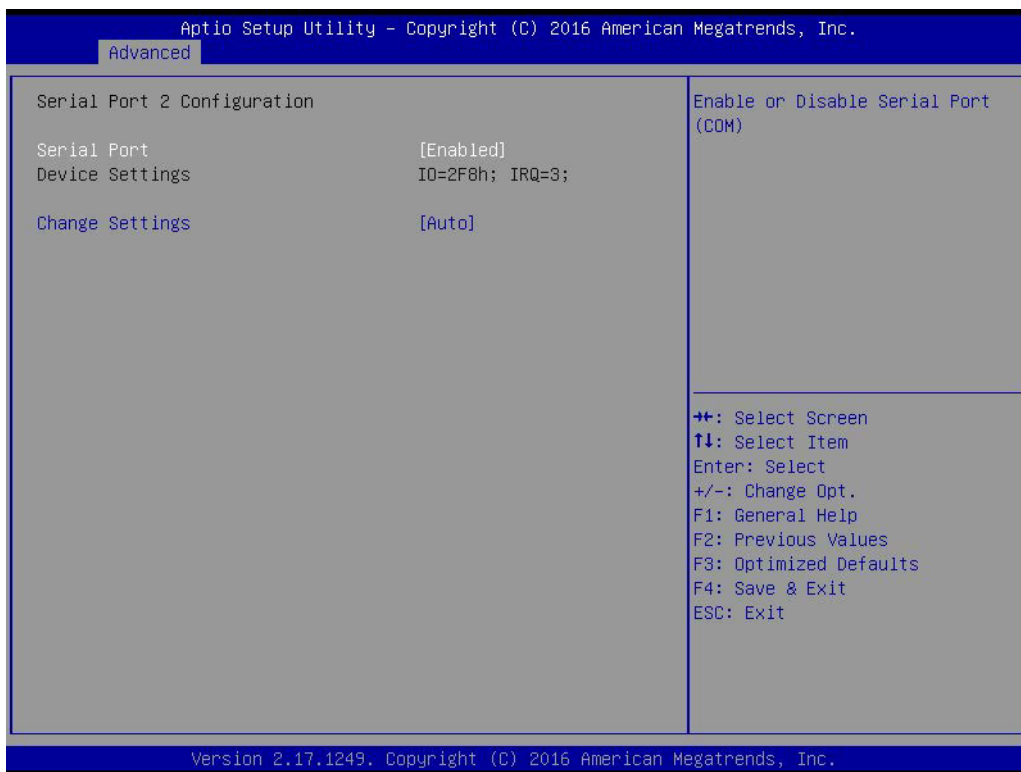

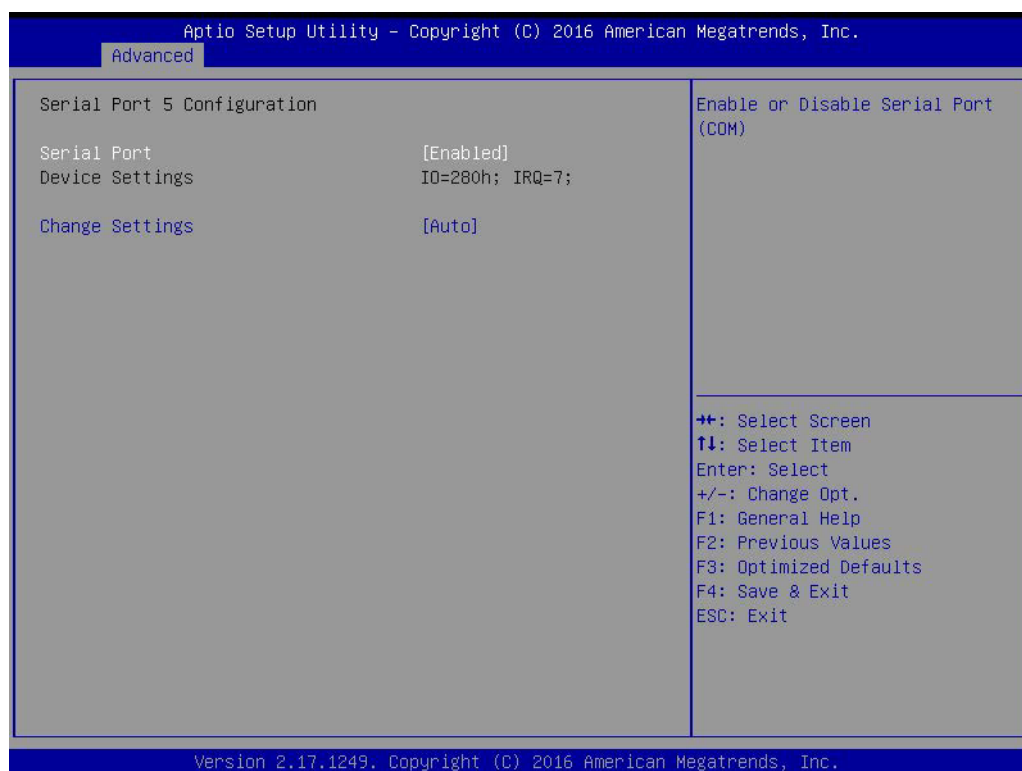
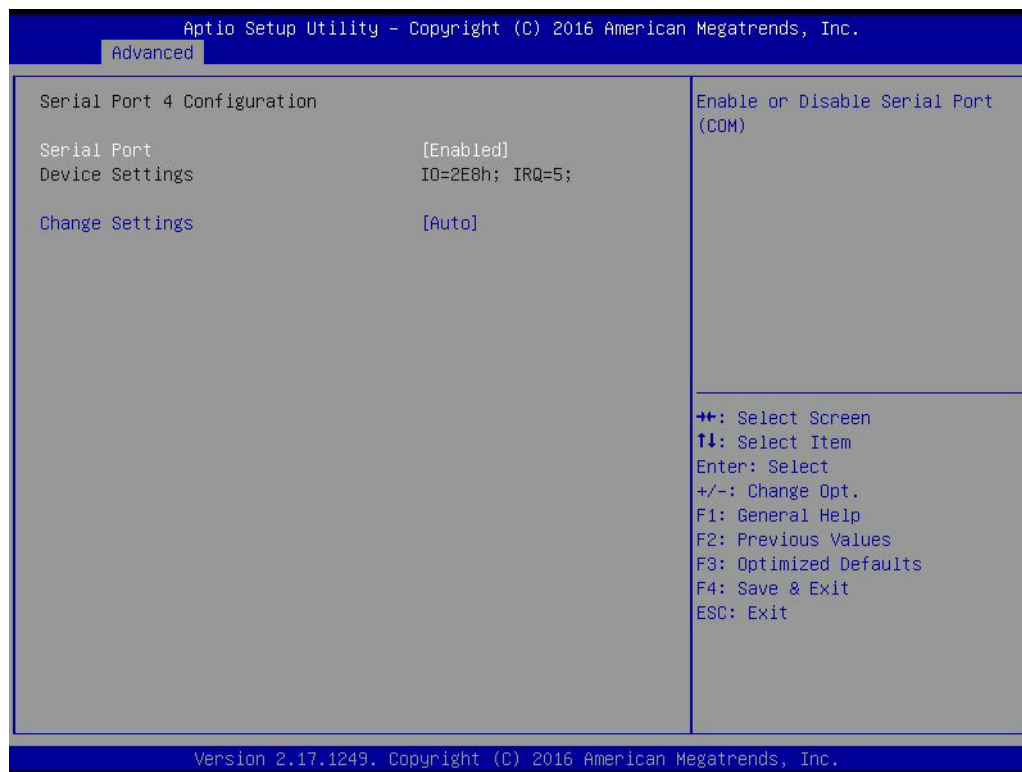

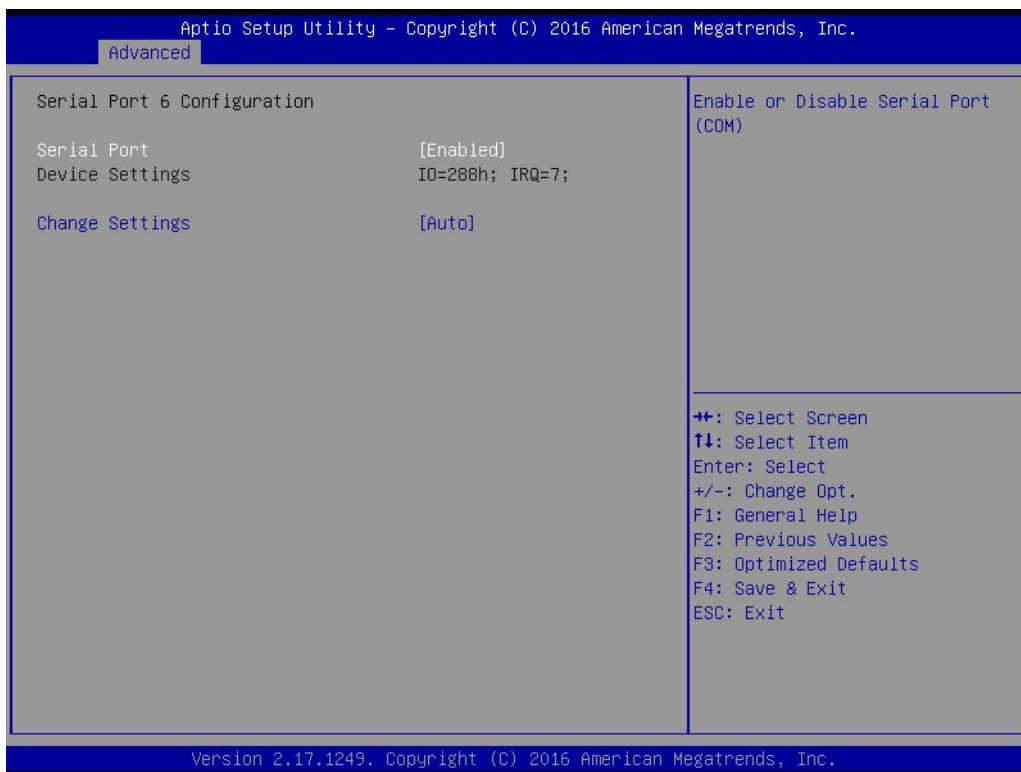

- **Serial Ports 1/2/3/4/5/6**  
This item allows users to enable or disable serial Ports 1/2/3/4/5/6.
- **Change Settings**  
This item allows users to change the settings for serial Ports 1/2/3/4/5/6.

### 3.2.2.5 PC Health Status

This page shows the PC health status of AIMB-216.

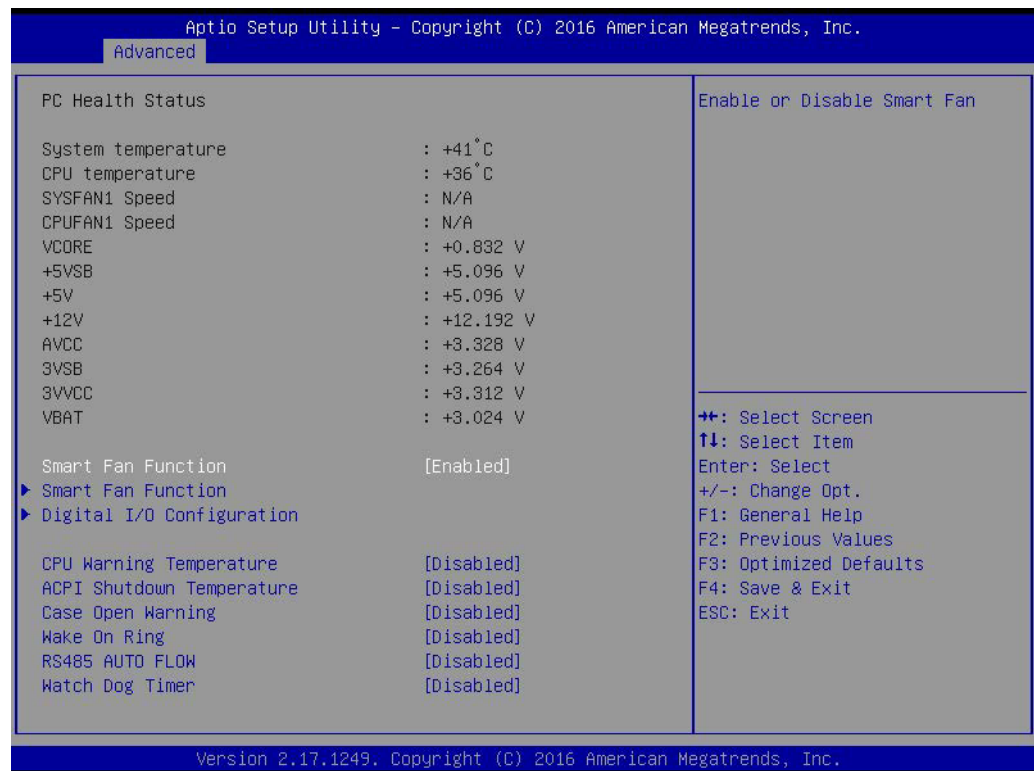

- **Smart Fan Function**  
This item allows users to enable or disable the System Smart Fan function.
- **CPU Warning Temperature**  
This item allows users to set the CPU warning temperature threshold. When the system CPU reaches the warning temperature, the buzzer will beep.
- **ACPI Shutdown Temperature**  
This item allows users to set the CPU temperature threshold at which the system automatically shuts down to prevent the CPU from overheating.
- **Case Open Warning**  
This item allows users to enable or disable the Case Open Warning function.
- **Wake On Ring**  
This item allows users to enable or disable Wake On Ring functionality.
- **RS-485 AUTO FLOW**  
This item allows users to enable or disable the RS-485 Auto Flow function.
- **Watchdog Timer**  
This item allows users to enable or disable the Watchdog Timer.



### 3.2.2.6 Smart Fan Mode Configuration

This page shows the Smart Fan Mode items.

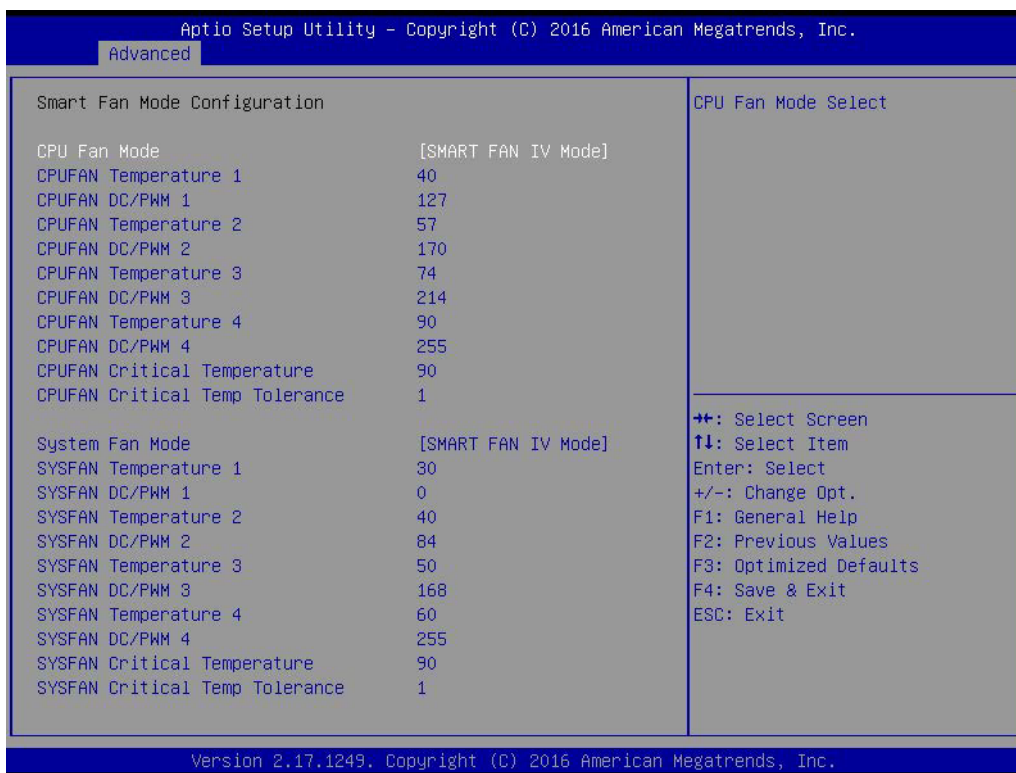

### 3.2.2.7 Digital I/O Configuration

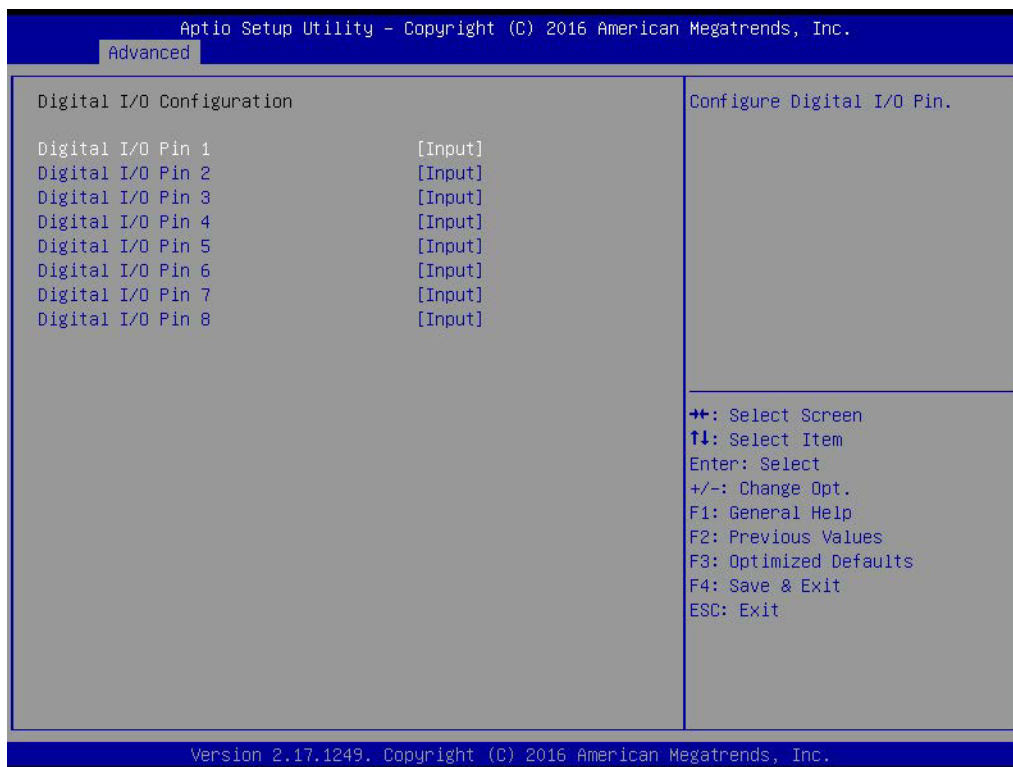

- **Digital I/O Configuration**

This item allows users to set digital I/O 1 to 8 as inputs or outputs.

### 3.2.2.8 S5 RTC Wake Settings

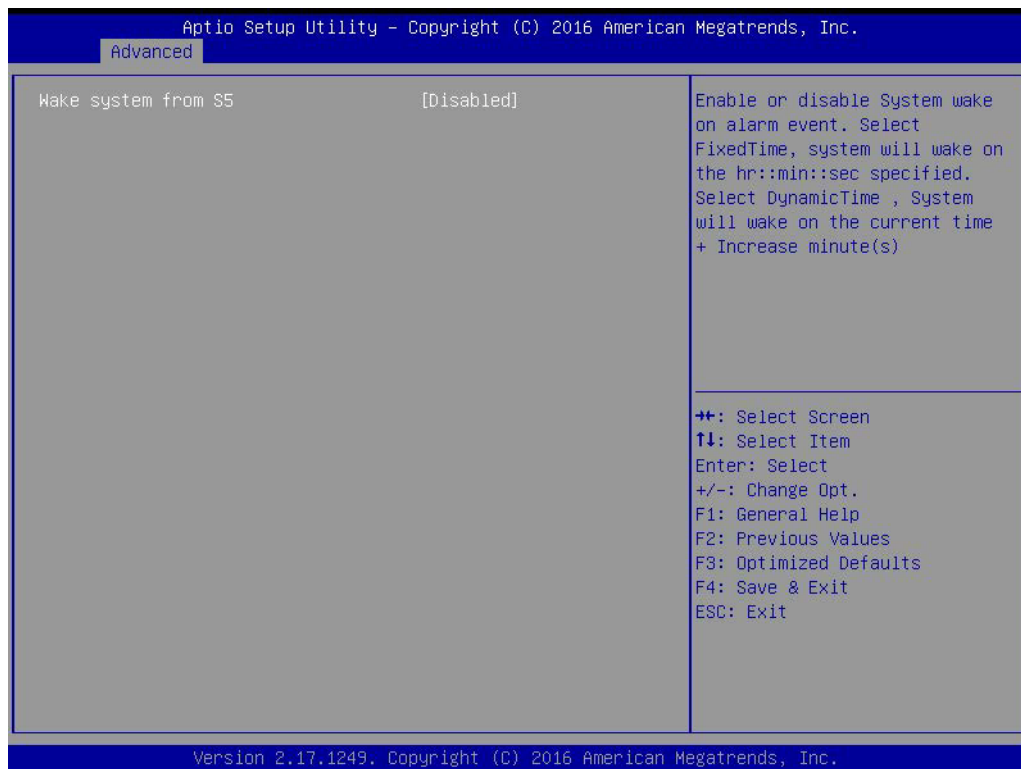

- **Wake System From S5**  
This item allows users to enable or disable system wake on alarm event.

### 3.2.2.9 Serial Port Console Redirection

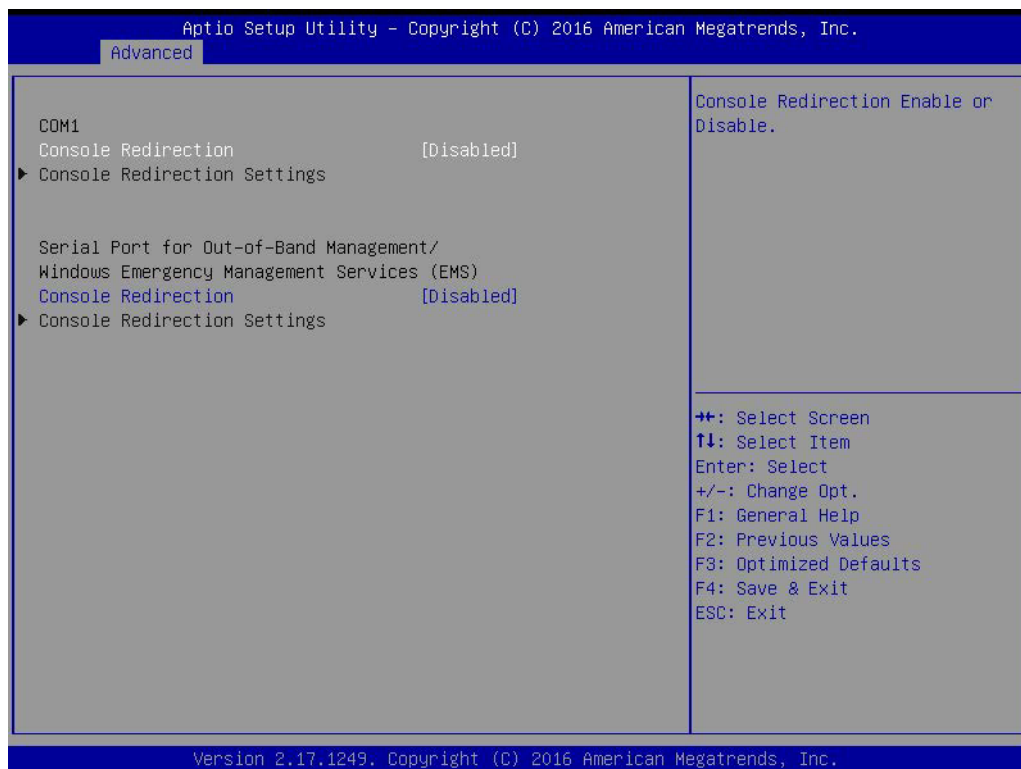

- **Console Redirection**  
This item allows users to enable or disable console redirection.

### 3.2.2.10 CPU Configuration



- **Limit CPUID Maximum**  
This item allows users to enable or disable Limit CPUID Maximum.
- **Bi-directional PROCHOT**  
This item allows users to enable or disable Bi-directional PROCHOT.
- **Intel Virtualization Technology**  
This item allows users to enable or disable Intel® Virtualization Technology.
- **Power Technology**  
This feature allows the user to configure power management settings. The options are Disabled, Energy Efficiency, and Custom.

This page shows the CPU information.

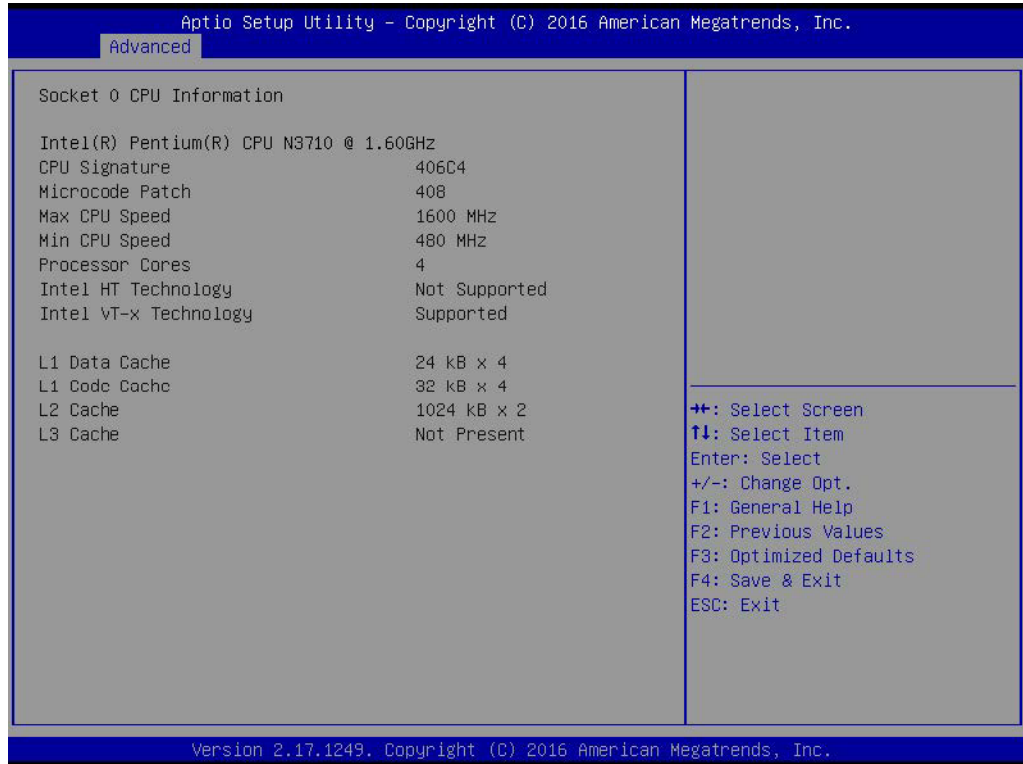

### 3.2.2.11 CPU Thermal Configuration



- **DTS**  
Enable or disable the Digital Thermal Sensor.

### 3.2.2.12 PPM Configuration

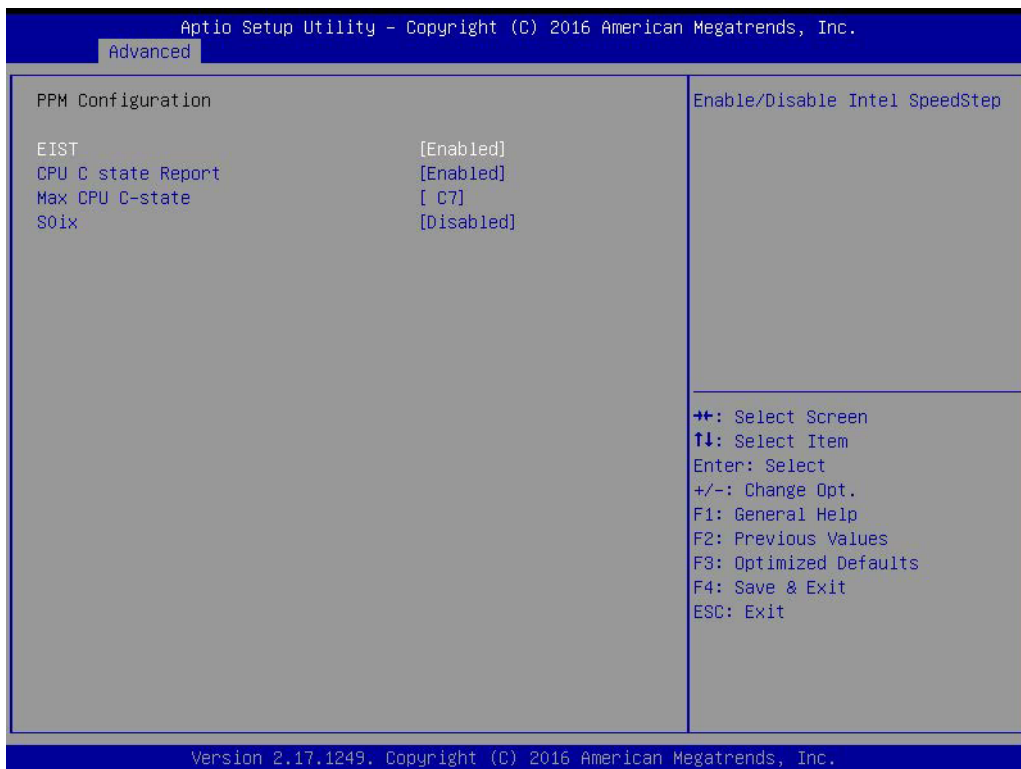

- **EIST**  
This item allows users to enable or disable Intel Speed Step function.
- **CPU C state Report**  
This item allows users to enable or disabled CPU C state report to OS.
- **Max CPU C-state**  
This option controls Max C state that the processor will support.
- **S0ix**  
This item allows users to enable or disable the CPU S0ix state.

### 3.2.2.13 SATA Configuration



- **SATA Controller**  
This item allows users to enable or disable the SATA device.
- **SATA Mode Selection**  
This item allows users to select mode of SATA controller(s).
- **SATA Interface Speed**  
This item allows users to select SATA speed [Gen1, Gen2, Gen3].
- **Aggressive LPM Support**  
This item allows users to enable or disable Aggressive LPM support.
- **Port 1**  
This item allows users to enable or disable the Serial-ATA Port 1 device.
- **Spin Up Device**  
This item allows users to enable or disable the Spin Up Device.
- **Device Sleep Support**  
This item allows users to enable or disable Device Sleep support.
- **Port 2**  
This item allows users to enable or disable the Serial-ATA Port 2 device
- **Spin Up Device**  
This item allows users to enable or disable the Spin Up Device.
- **Device Sleep Support**  
This item allows users to enable or disable Device Sleep support.

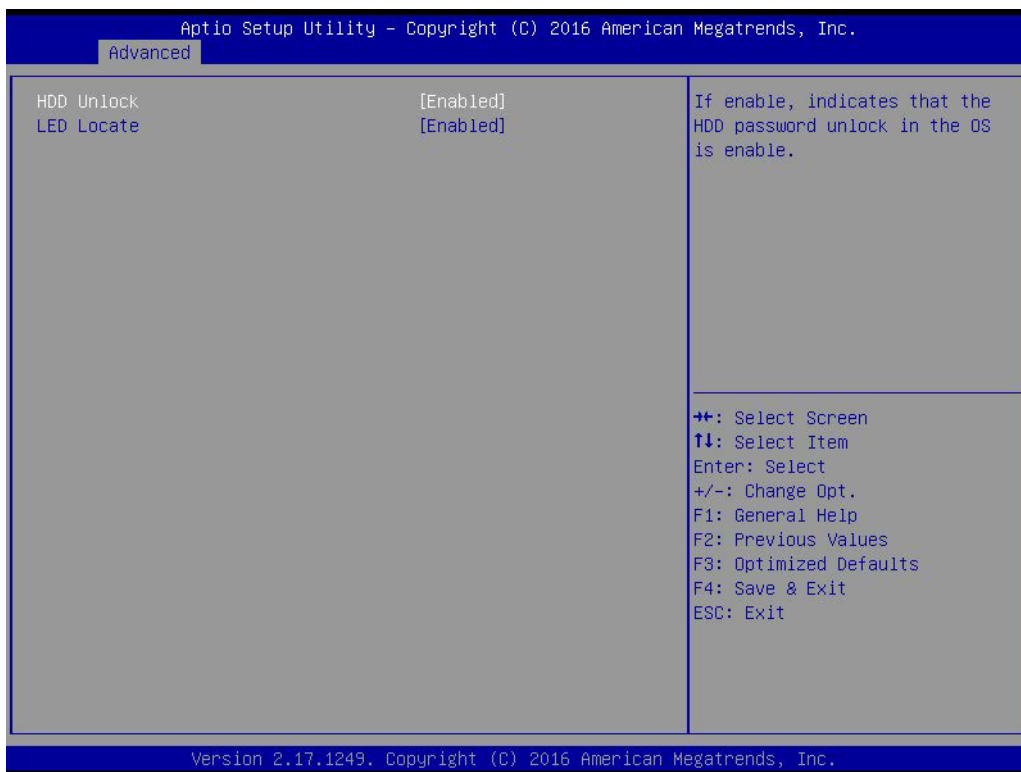

- **HDD Unlock**  
To enable or disable HDD Unlock. If enabled, it indicates that the HDD password unlock in the OS is enabled.
- **LED Locate**  
To enable or disable LED Locate.

### 3.2.2.14 Miscellaneous Configuration

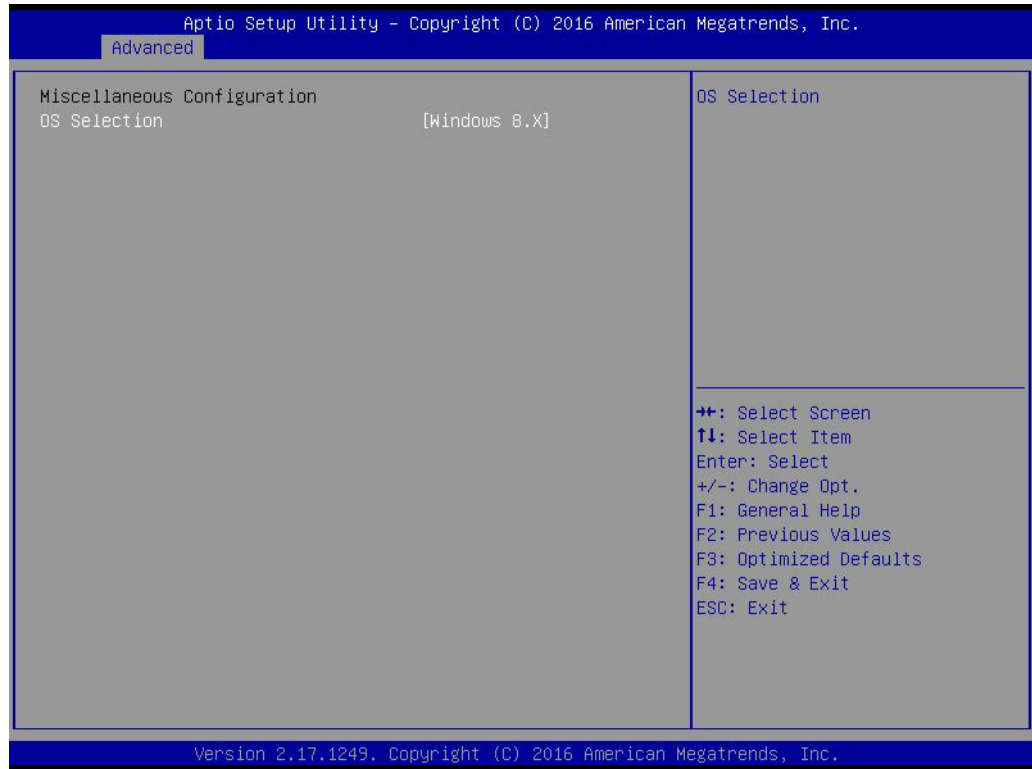

- **OS Selection**

This item allows users to select the OS as Windows 7 or Windows 8.x for use.

### 3.2.2.15 Network Stack Configuration



- **Network Stack**

Enable or disable UEFI Network Stack.



### 3.2.2.16 Compatibility Support Module Configuration

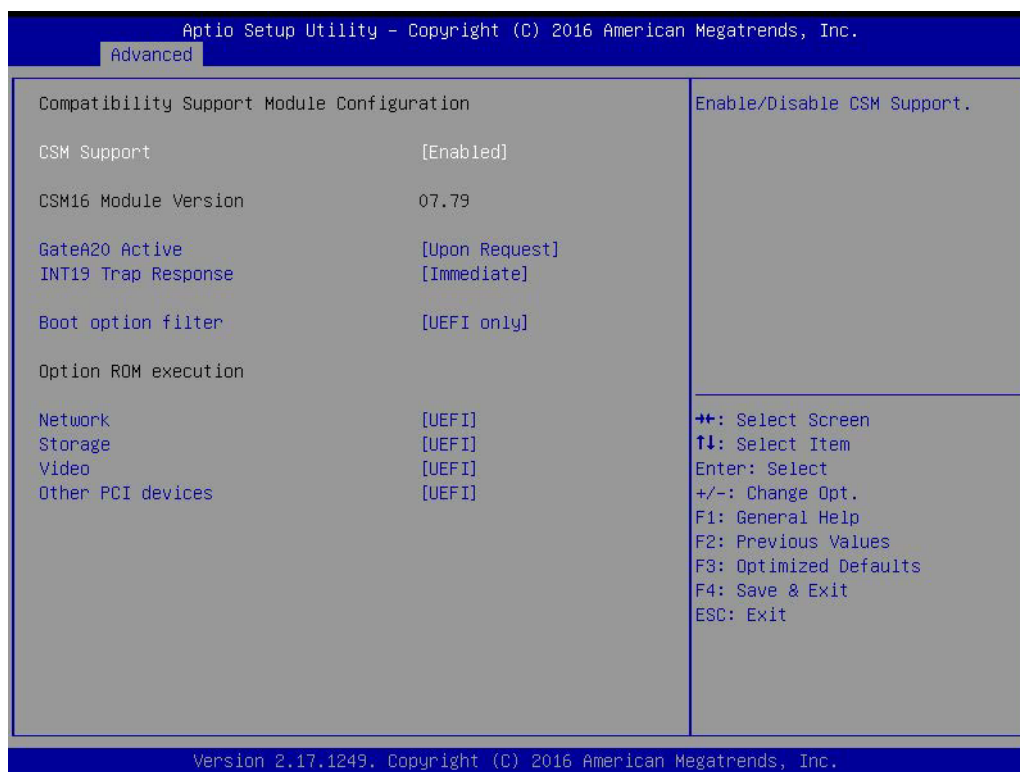

- **CSM Support**  
This item allows users to enable or disable CSM support.
- **GateA20 Active**  
Upon request - GA20 can be disabled using BIOS services. Never allow disabling of GA20; this option is useful when any RT code is executed above 1MB.
- **INT19 Trap Response**  
This item allows users to set the BIOS reaction to INT19 trapping by Option ROM: "Immediate" - execute the trap right away; "postponed" - execute the trap during legacy boot.
- **Boot Options Filter**  
This item allows users to control the Legacy/UEFI ROM priority.
- **Option ROM Execution**
  - **Network**  
Controls the execution of UEFI and Legacy PXE OpROM.
  - **Storage**  
Controls the execution of UEFI and Legacy Storage OpROM.
  - **Video**  
Controls the execution of UEFI and Legacy Video OpROM.
  - **Other PCI devices**  
Determines the OpROM execution policy for devices other than network, storage, and/or video devices.

### 3.2.2.17 NVMe controller and Drive information

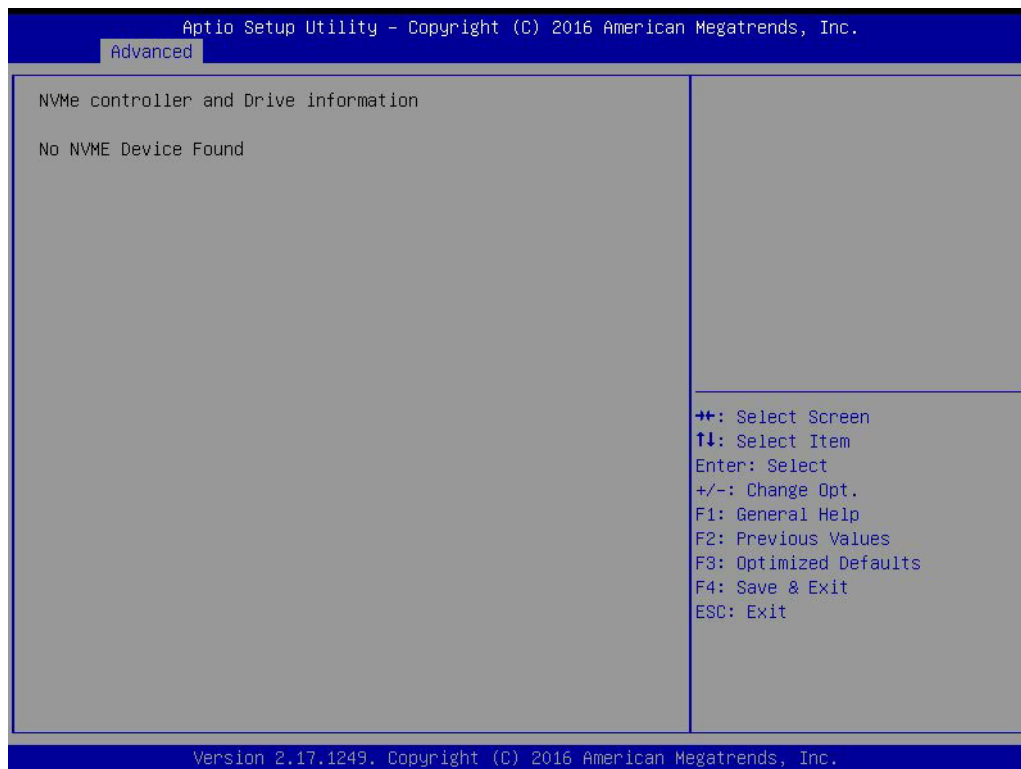

### 3.2.2.18 USB Configuration

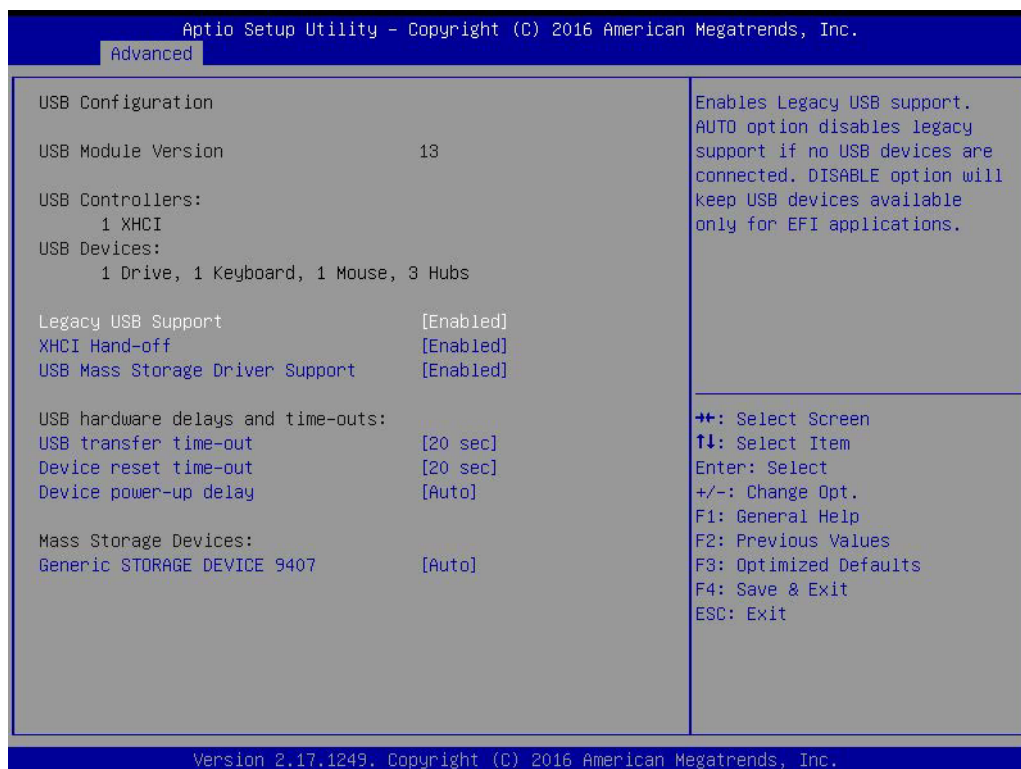

- **Legacy USB support**  
This item allows users to enable or disable support for legacy USB. The “Auto” option disables legacy support if no USB devices are connected.
- **XHCI Hands Off**  
This is a workaround for OS without XHCI hands-off support. The change in XHCI ownership should be claimed by the XHCI driver.
- **EHCI Hands Off**  
This is a workaround for OS without EHCI hands-off support. The change in EHCI ownership should be claimed by the EHCI driver.
- **USB Mass Storage Driver Support**  
This item allows users to enable or disable the USB mass storage driver.
- **USB Transfer Timeouts**  
Time-out value for control, bulk, and interrupt transfers.
- **Device Reset Timeout**  
USB mass storage device starts unit command time-out.
- **Device Power-up Delay**  
Maximum time the device will take before it properly report itself to the host controller.
- **Mass Storage Device**  
Mass storage device emulation type. 'AUTO' enumerates devices according to their media format. Optical drives are emulated as 'CDROM', drives with no media will be emulated according to a drive type.

### 3.2.2.19 Security Configuration



- **TXE HMRFP0**  
This item allows users to enable or disable TXE HMRFP0.
- **TXE Firmware Update**  
This item allows users to enable or disable TXE firmware updates.
- **TXE EOP Message**  
Send EOP message before entering the OS.

### 3.2.3 Chipset

This page provides information of the chipset on AIMB-216.

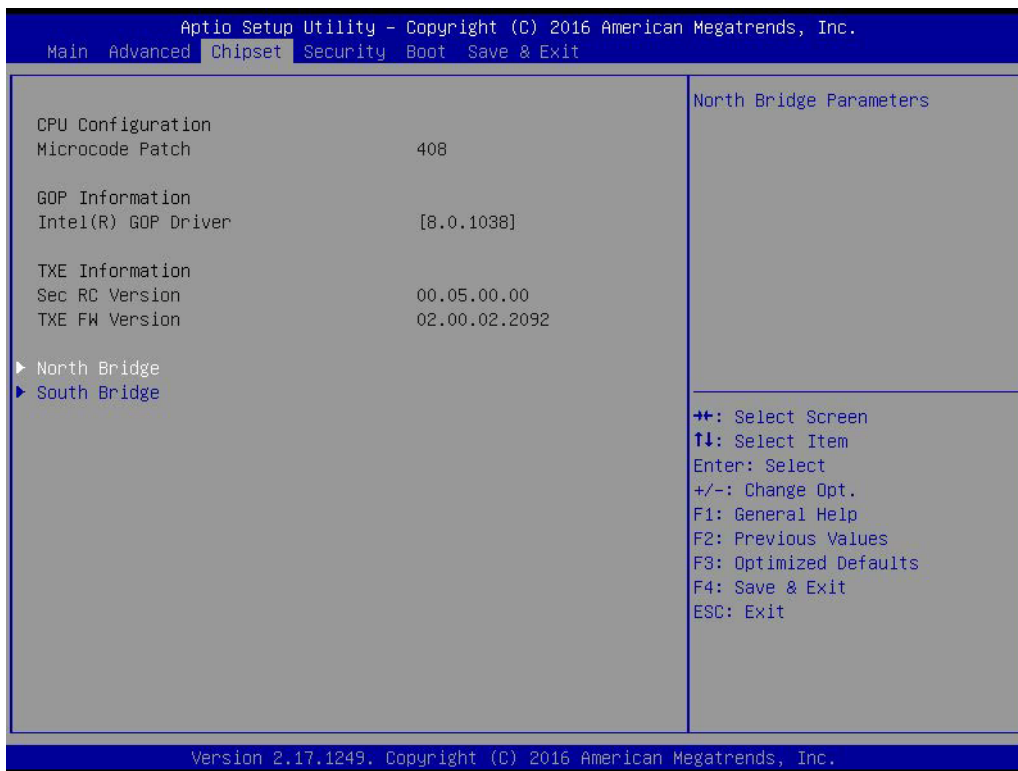

#### 3.2.3.1 North Bridge



#### ■ Max TOLUD

This item allows users to select the maximum value of TOLUD.

### 3.2.3.2 Intel IGD Configuration

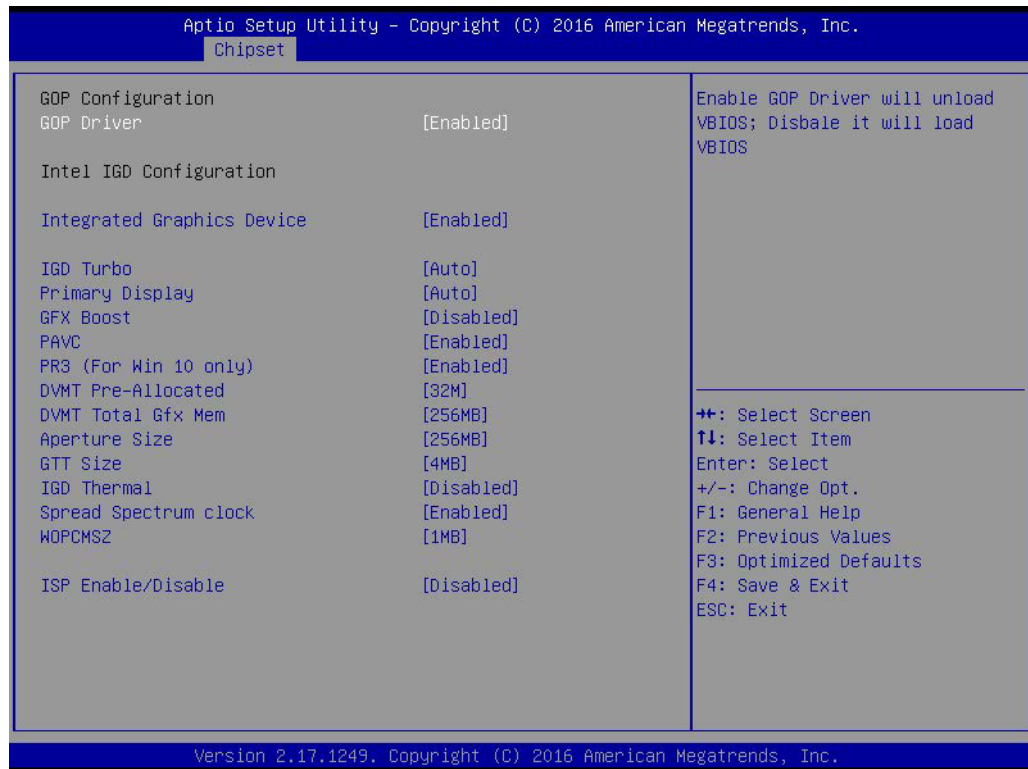

- **GOP Driver**

Enable or disable GOP Driver. Enabling GOP Driver will unload VBIOS; Disabling it will load VBIOS.

#### Intel IGD Configuration

- **Integrated Graphics Device**

Enable: Enable Integrated Graphics Device (IGD) when selected as the primary video adaptor.

Disable: Always disable IGD.

- **GD Turbo**

Select the IGD Turbo feature, if Auto selected, IGD Turbo will only be enabled when SOC stepping is B0 or above.

- **Primary Display**

Select which of IGD/PCI Graphics device should be the primary display.

- **GFX Boost**

Enable or disable GFX Boost.

- **PAVC**

Enable or disable Protected Audio Video Control.

- **PR3 (For Win 10 only)**

Enable or disable PR3 (For Win 10 only).

- **DVMT Pre-Allocated**

Select DVMT 5.0 Pre-Allocated (Fixed) graphics memory size used by the

- **Internal Graphics Device.**

- **DVMT Total Gfx Mem**

Select DVMT 5.0 Total graphic memory size used by the internal graphics device.

- **Aperture Size**  
Select the Aperture Size.
- **GTT Size**  
Select the GTT Size.
- **IGD Thermal**  
Enable or disable IGD Thermal.
- **Spread Spectrum clock**  
Enable or disable Spread Spectrum clock.
- **WOPCMSZ**  
Select a size for WOPCMSZ.
- **ISP Enable/Disable**  
Enable or disable ISP PCI device selection.

### 3.2.3.3 Graphics Power Management Control

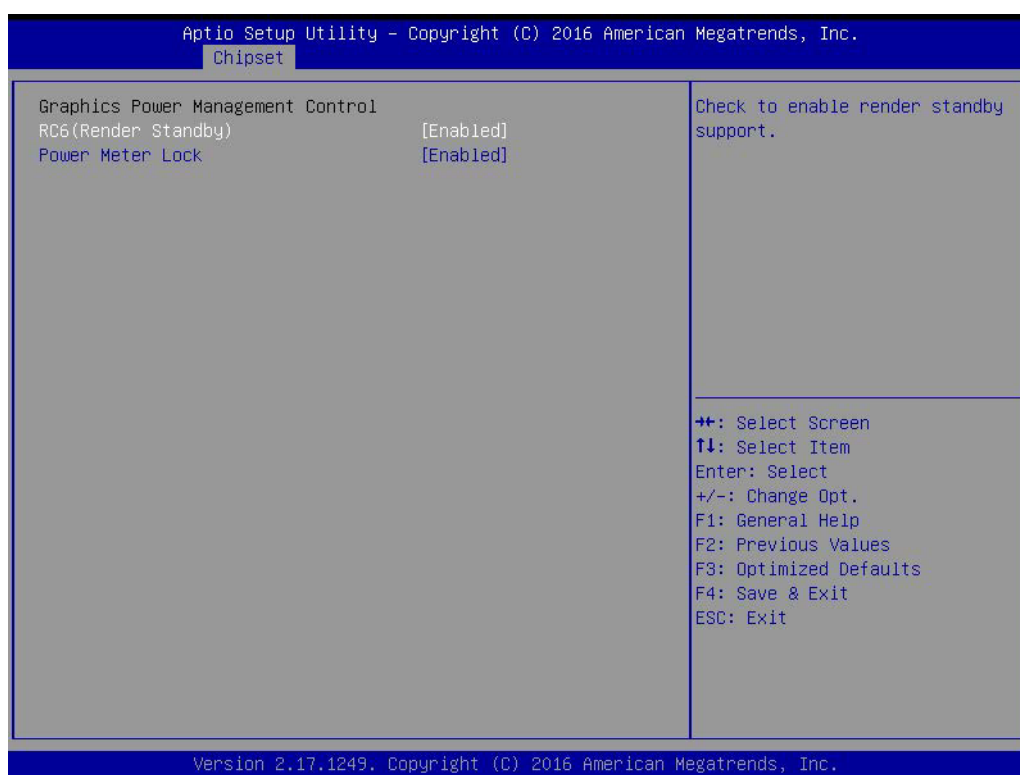

- **RC6 (Render Standby)**  
This item allows users to enable render standby support.
- **Power Meter Lock**  
Enable or disable Power Meter Lock.

### 3.2.3.4 Memory Configuration Options

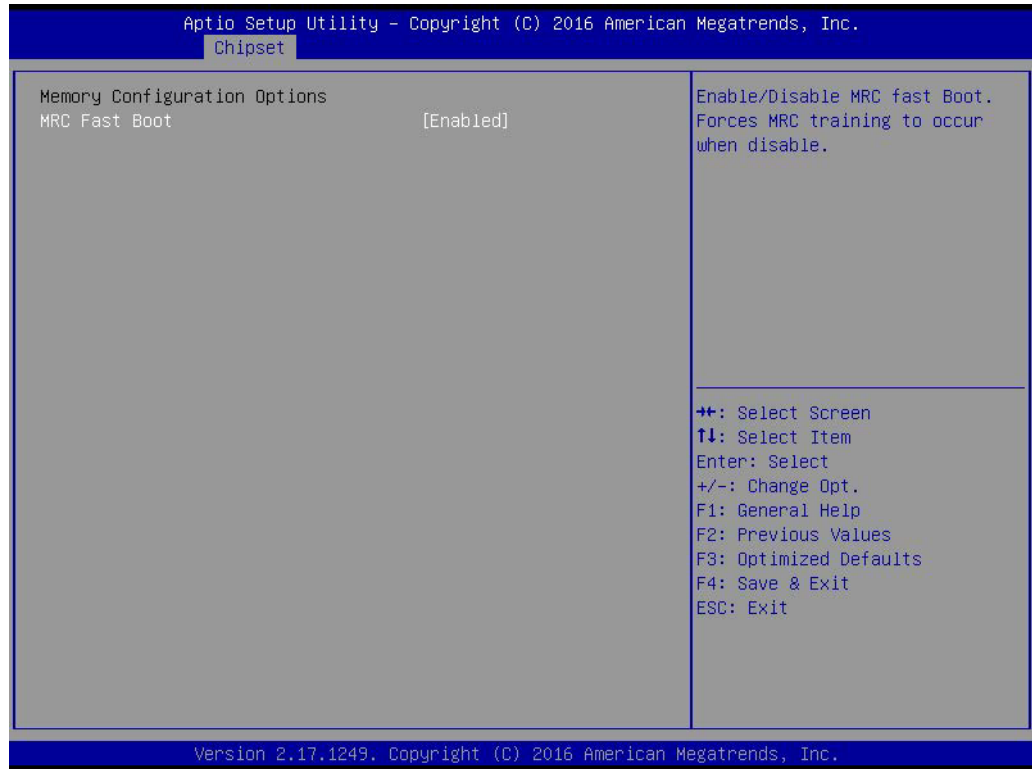

- **MRC Fast Boot**

Enable or disable MRC Fast Boot. Forces MRC training to occur when disable.

### 3.2.3.5 LCD Control

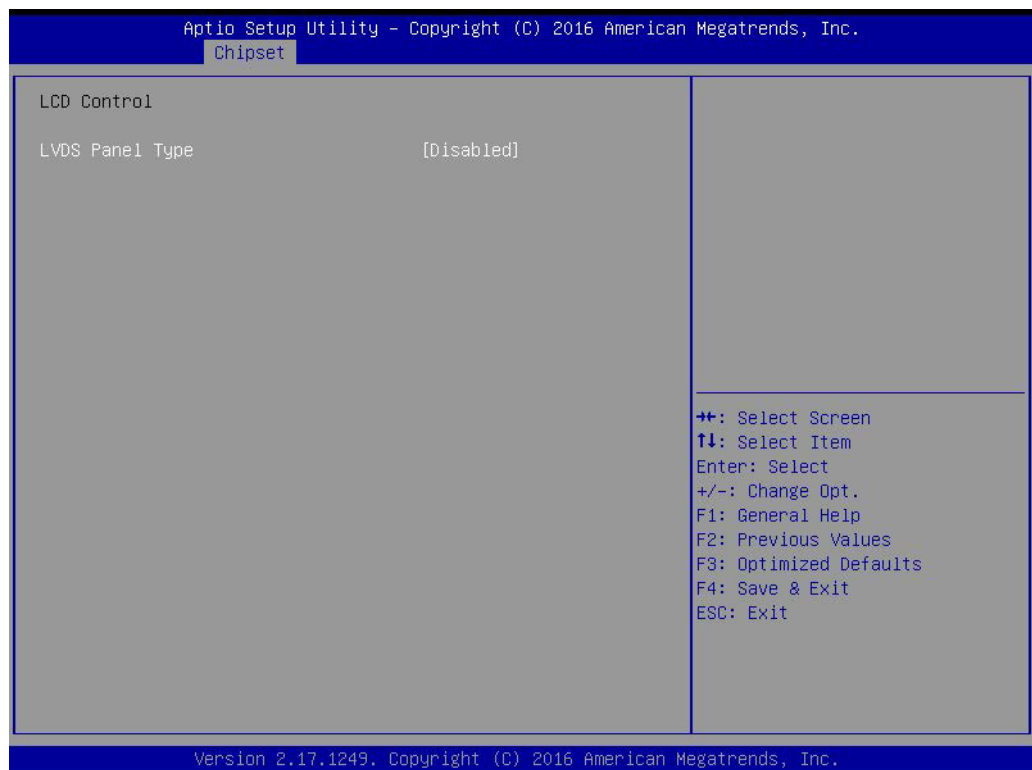

- **LVDS Panel Type**

LVDS Panel Type selection.



### 3.2.3.6 South Bridge

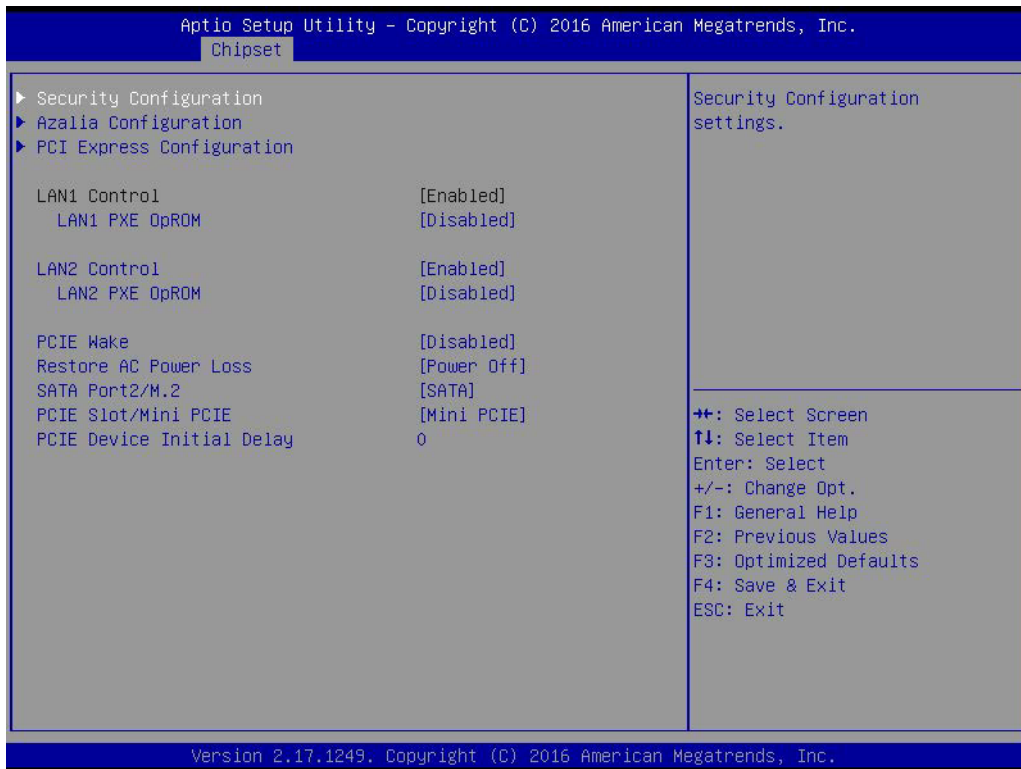

- **LAN 1 Controller**  
Enable or disable the LAN 1 controller.
- **LAN 1 PXE OpROM**  
Enable or disable the boot option for LAN1 controller.
- **LAN 2 controller**  
Enable or disable the LAN 2 controller.
- **LAN 2 PXE OpROM**  
Enable or disable the boot option for LAN2 controller.
- **PCIE Wake**  
Enable or disable PCIE to wake the system from S5.
- **Restore AC Power Loss**  
This item allows users to select off, on and last state.
- **SATA Port2/M.2**  
Select SATA Port2 or M.2 to be used.
- **PCIE Slot/Mini PCIE**  
Select PCIE Slot or Mini PCIE to be used.
- **PCIE Device Initial Delay**  
The PCIE device initial delay time select.

### 3.2.3.7 Security Configuration

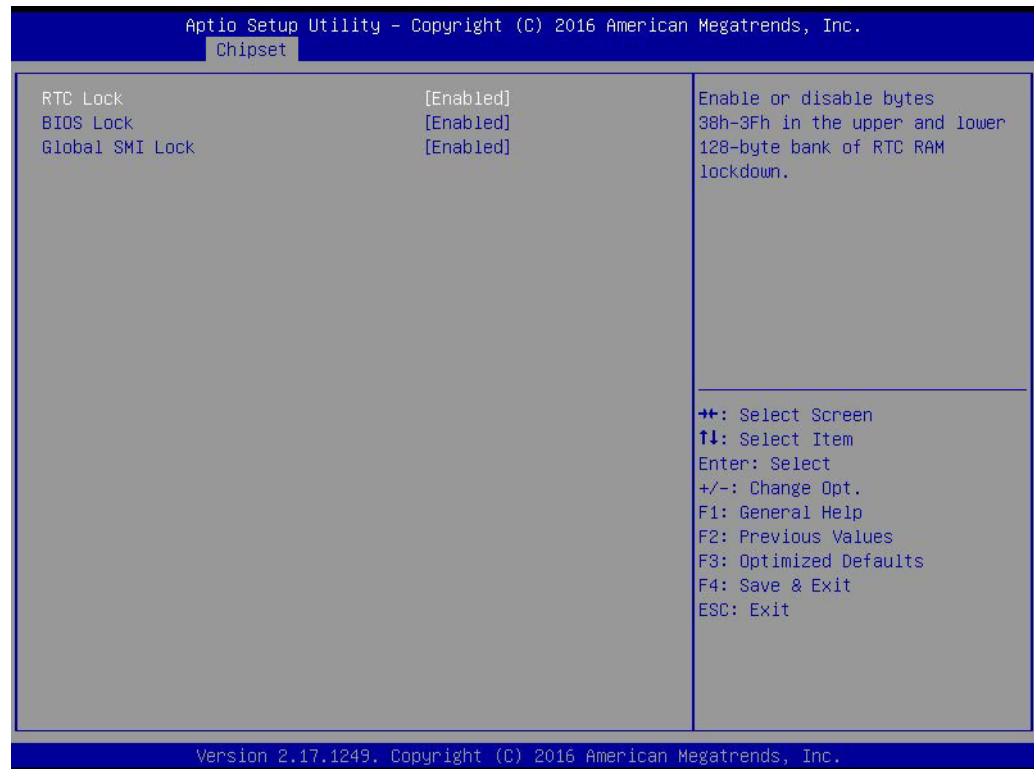

- **RTC Lock**  
Enable or disable bytes 38h-3Fh in the upper and lower 128-byte bank of RTC RAM lockdown.
- **BIOS Lock**  
Enable/Disable the BIOS Lock Enable feature.
- **Global SMI Lock**  
Enable or disable SMI Lock.

### 3.2.3.8 Audio Configuration

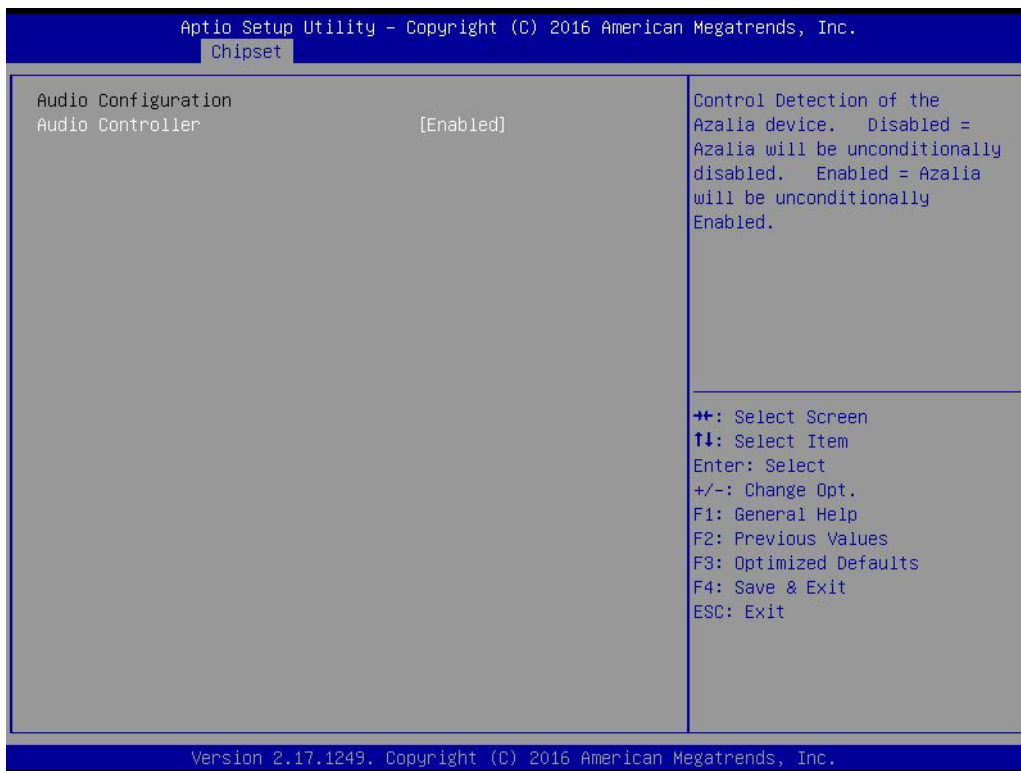

- **Audio Controller**  
Control Detection of the Azalia device.  
Disabled = Azalia will be unconditionally disabled. Enabled= Azalia will be unconditionally Enabled.

### 3.2.3.9 PCI Express Configuration

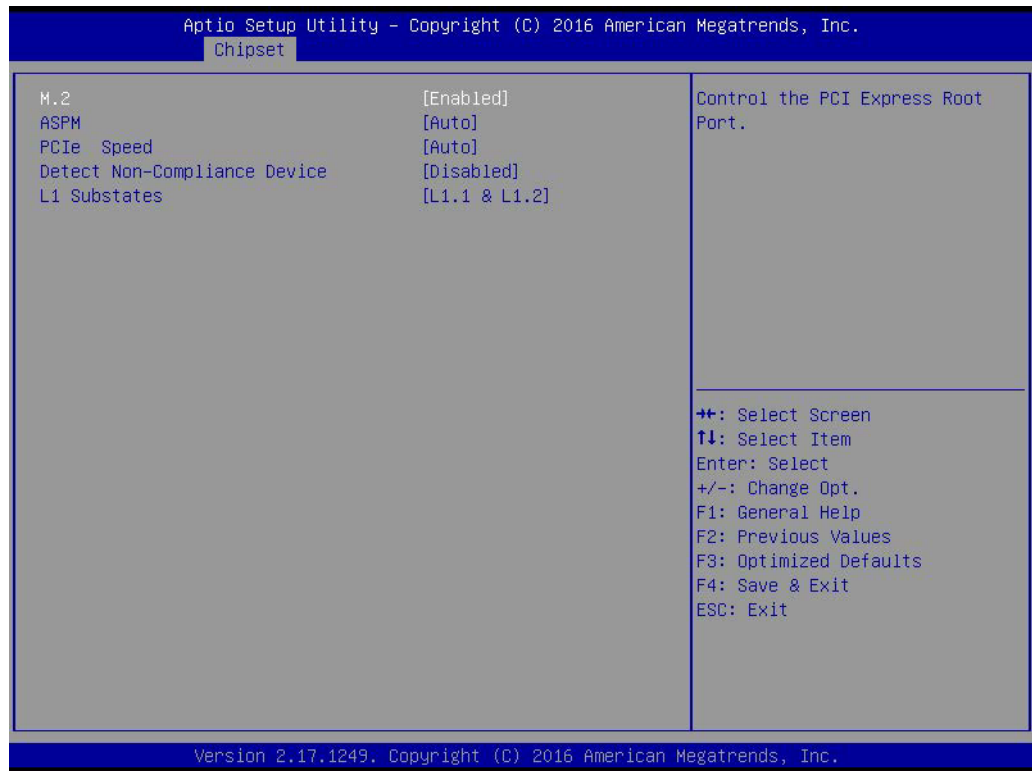

- **M.2**  
Control the PCI Express Root Port of M.2
- **ASPM**  
PCI Express Active State Power Management settings.
- **PCIe Speed**  
Configure PCIe Speed. CHV A1 always with Gen1 Speed.
- **Detect Non-Compliance Device**  
Detects non compliant PCI Express devices. If enabled, it will take more time during POST.
- **L1 Substates**  
PCI Express L1 Substates settings.

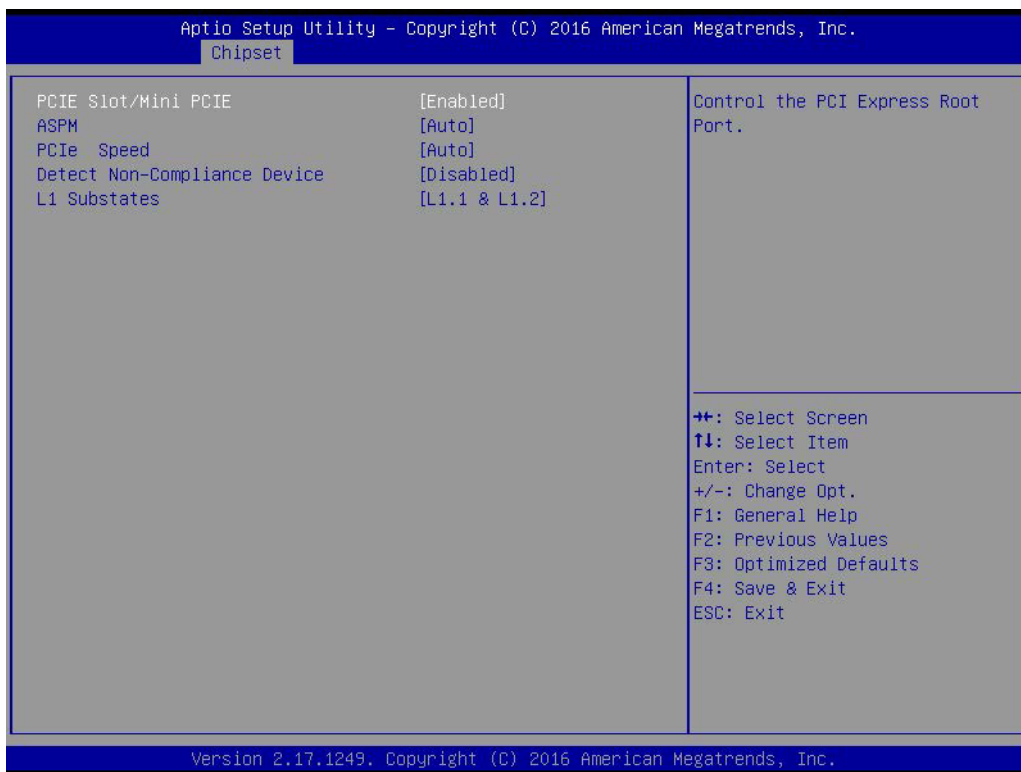

- **PCIE Slot/Mini PCIE**  
Control the PCI Express Root Port of PCIE Slot/Mini PCIE
- **ASPM**  
PCI Express Active State Power Management settings.
- **PCIe Speed**  
Configure PCIe Speed. CHV A1 always with Gen1 Speed.
- **Detect Non-Compliance Device**  
Detects non compliant PCI Express devices. If enabled, it will take more time during POST.
- **L1 Substates**  
PCI Express L1 substates settings.

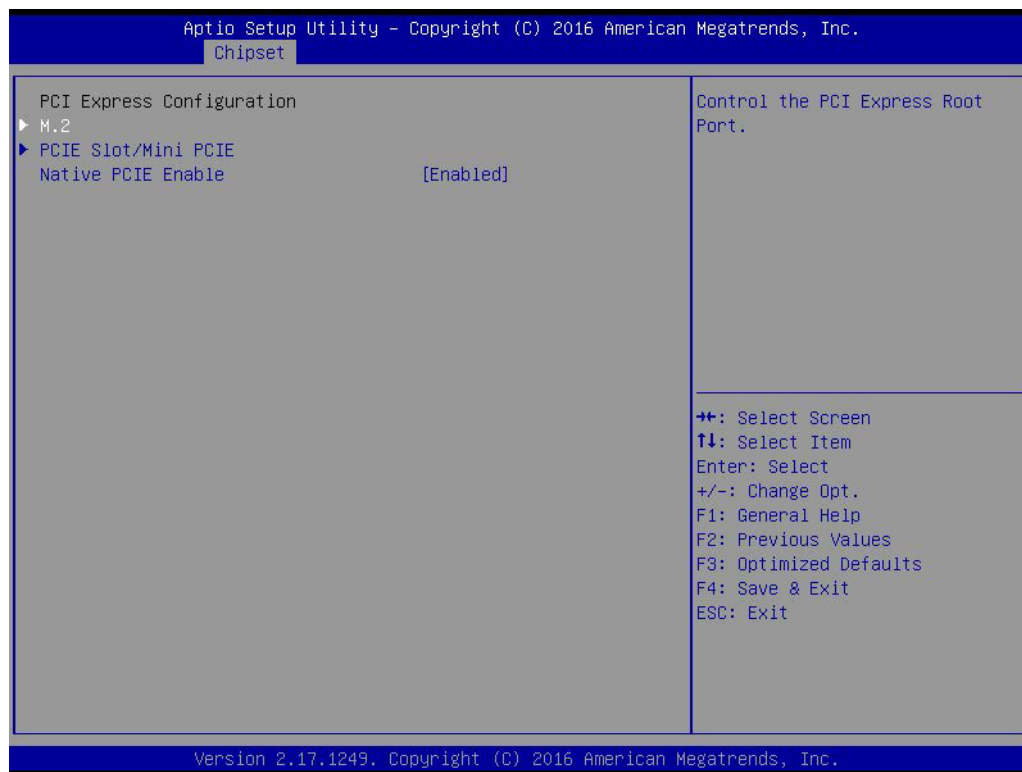

■ **Native PCIE Enable**

PCI Express Native Support Enable/Disable. This feature is only available in Vista.

### 3.2.4 Security

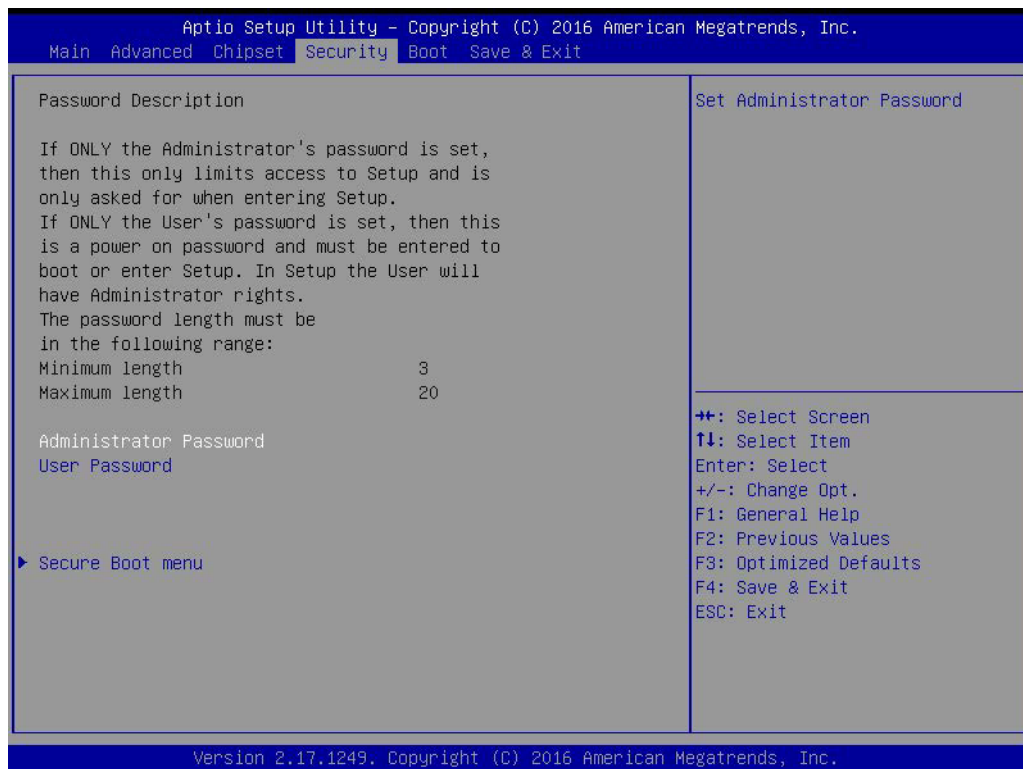

Select Security Setup from the AIMB-216 Setup main BIOS setup menu. All Security Setup options, such as password protection and virus protection are described in this section. To access the sub menu for the following items, select the item and press<Enter>: Change Administrator / User Password.

### 3.2.4.1 Secure Boot menu

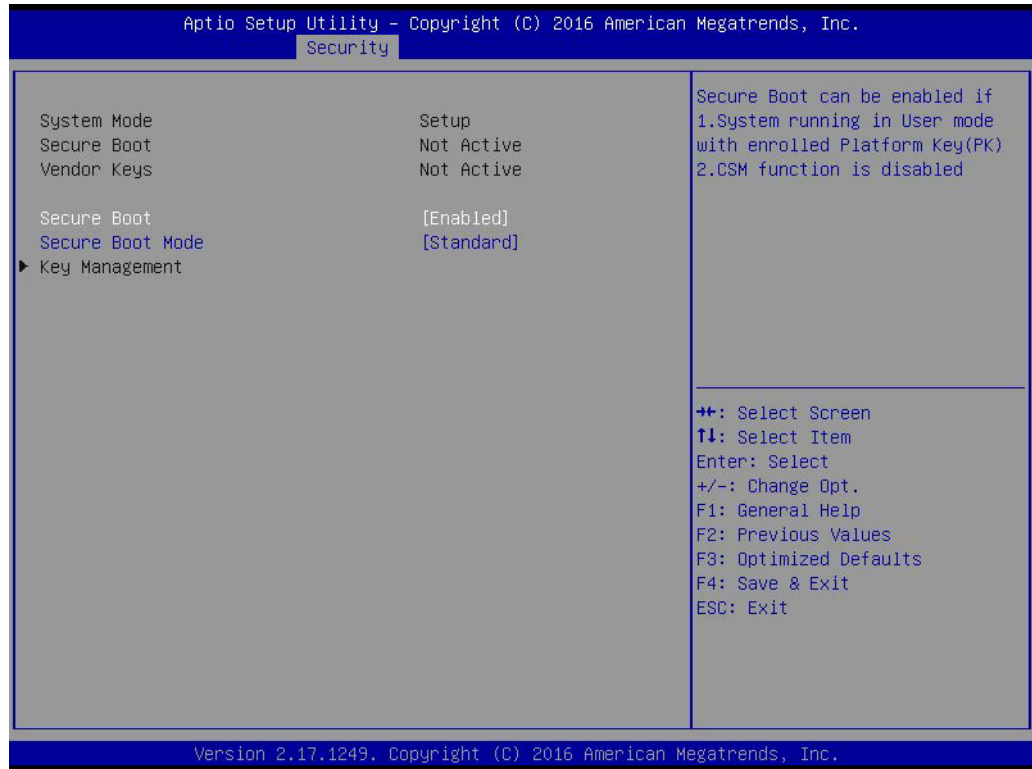

- **Secure Boot**

Enable or disable Secure Boot. Secure Boot can be enabled if

1. The system is running in user mode with enrolled platform key (PK)
2. The CSM function is disabled.

- **Secure Boot Mode**

Secure Boot mode selector. "Custom" Mode enables users to change Image Execution policy and manage Secure Boot Keys.



### 3.2.5 Boot

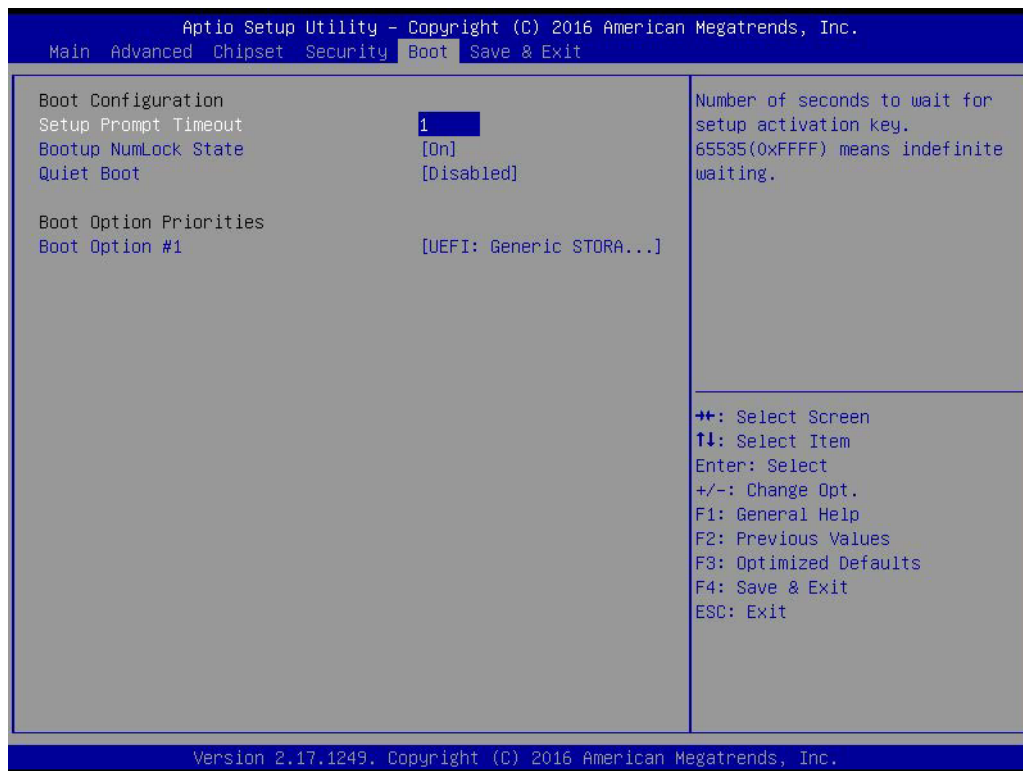

- **Setup Prompt Timeout**  
This item allows you to change number of seconds to wait for setup activation key.
- **Bootup NumLock State**  
Selects the keyboard Numlock state.
- **Quiet Boot**  
Enable or disable Quiet Boot option.

## 3.2.6 Save and Exit

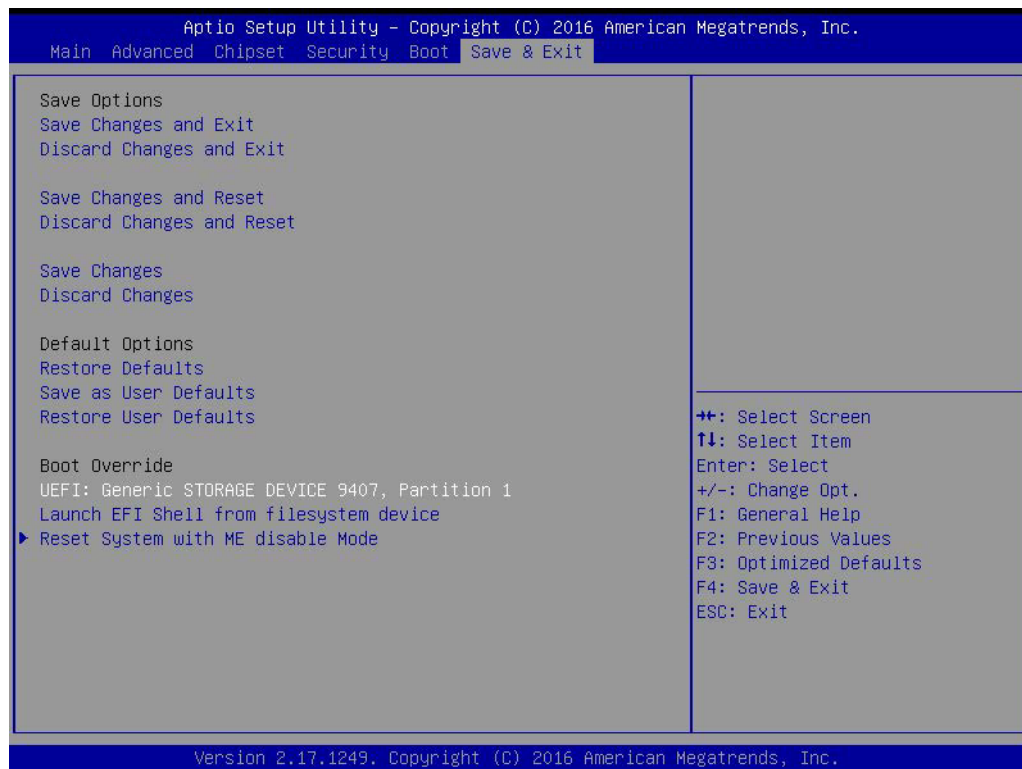

- **Save Changes and Exit**  
This item allows users to exit system setup after saving changes.
- **Discard Changes and Exit**  
This item allows users to exit the system setup without saving changes.
- **Save Changes and Reset**  
This item allows users to reset the system setup after saving changes.
- **Discard Changes and Reset**  
This item allows users to reset the system setup without saving changes.
- **Save Changes**  
This item allows users to save changes done so far to any of the setup options.
- **Discard Changes**  
This item allows users to discard changes done so far to any of the setup options.
- **Restore Defaults**  
This item allows users to restore/load the default values for all options.
- **Save as User Defaults**  
This item allows users to save changes done so far as user defaults.
- **Restore User Defaults**  
This item allows users to restore the user defaults for all options.
- **Launch EFI Shell From a File system Device**  
Attempts to Launch EFI Shell application (Shell.efi) from one of the available filesystem devices.
- **Reset System with ME disable Mode**  
ME will runs into the temporary disable mode, Ignore if ME Ignition FW.

# Chapter 4

Software and Service  
Introduction

## 4.1 Introduction

The mission of Advantech Embedded Software Services is to “enhance users’ quality of life with Advantech platforms and Microsoft® Windows® embedded technology”. We equip Advantech platforms with Windows® embedded software products to more effectively support the embedded computing community. This eliminates the hassle of dealing with multiple vendors (hardware suppliers, system integrators, and embedded OS distributors) for specific projects. Our aim is to make Windows® embedded software solutions widely available to the embedded computing community.

## 4.2 Value-Added Software Services

Software API: An interface that defines the ways in which an application program may request services from libraries and/or operating systems. This software provides not only the underlying drivers required, but also a rich set of user-friendly, intelligent, and integrated interfaces that speed development, enhance security, and offer add-on value for Advantech platforms. Furthermore, this software serves as a catalyst between developers and solutions, making Advantech embedded platforms easier and simpler to adopt and operate with customer applications.

### 4.2.1 Software API

#### 4.2.1.1 Control

##### GPIO



General purpose input/output is a flexible parallel interface that allows various custom connections. This interface also enables users to monitor the level of signal input or set the output status to switch the device on or off. Our API also provides programmable GPIO, enabling developers to dynamically set the GPIO input or output status.

##### SMBus



SMBus is a system management bus defined by Intel Corporation in 1995. This interface is used in personal computers and servers for low-speed system management communications. The SMBus API allows developers to interface with an embedded system environment and transfer serial messages using SMBus protocols, facilitating multiple simultaneous device control.

#### 4.2.1.2 Display

##### Brightness Control



The Brightness Control API allows developers to access embedded devices and easily control brightness.

### Backlight



The Backlight API allows developers to control the backlight (screen) in embedded devices.

#### 4.2.1.3 Monitor

### Watchdog



A watchdog timer is a device that performs a specific operation after a specified period of time when a malfunction occurs and the system cannot recover on its own. A watchdog timer can be programmed to perform a warm booting (system restart) after a certain number of seconds.

### Hardware Monitor



The Hardware Monitor API is a system health supervision API that inspects certain condition indices, such as fan speed, temperature, and voltage.

#### 4.2.1.4 Power Saving

### CPU Speed



This feature uses Intel SpeedStep® Technology to reduce the system power consumption. The system automatically adjusts the CPU speed according to the system load.

### System Throttling

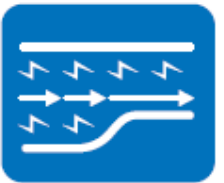

This refers to a series of methods for reducing system power consumption by lowering the clock frequency. This API allows users to adjust the clock frequency from 87.5% to 12.5%.

---

## 4.2.2 Software Utility

### BIOS Flash

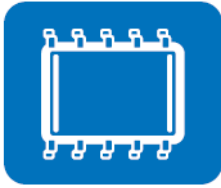

The BIOS Flash utility allows customers to update the flash ROM BIOS version, or backup the current BIOS by copying the configuration from the flash chip to a file on the users' disk. The BIOS Flash utility also features a command line version and API for rapid implementation in customized applications.

### Embedded Security ID



Embedded applications are the most important responsibilities for system integrators because they contain valuable intellectual property, design knowledge, and innovations, and are easily copied. This Embedded Security ID utility offers reliable security functions that allow users to secure application data within embedded BIOS.

### Monitoring



The Monitoring API is a utility that allows users to monitor the system health indicators, such as voltage, CPU and system temperature, and fan speed. These system values are crucial. If critical errors occur and are not solved immediately, permanent damage to the device may result.

# Chapter 5

Chipset Software  
Install Utility

## 5.1 Before Installation

Before installing the enhanced display drivers and utility software, please read the instructions provided in this chapter carefully. The drivers for AIMB-216 are provided on Advantech support website: <http://support.advantech.com/Support/>. This driver will guide and link users to the utilities and drivers required for Microsoft Windows-based systems. Software updates can be accessed from Microsoft\* software service packs.

**Note!** *The files on the website are compressed. Do not attempt to install the drivers by copying the files manually. The setup program provided must be used to install the drivers.*



Please note, for most display drivers, the relevant software application must be installed on the system before enhanced display drivers can be installed. In addition, for many of the installation procedures, user familiarity with both the relevant software applications and operating system commands is assumed. Thus, users are advised to review relevant operating system commands and pertinent sections of the application software user manual before attempting installation.

## 5.2 Introduction

The Intel® Chipset Software Installation (CSI) utility installs the Microsoft Windows INF files that specify the chipset component configuration on the OS. This is essential to enable the following features and functionalities:

- Core PCI PnP services
- Serial ATA interface support
- USB support
- Identification of Intel® chipset components in the device manager

**Note!** *This utility is used for the following versions of Windows, and it has to be installed before installing all the other drivers:*



- Windows 7 (32-bit)
- Windows 7 (64-bit)
- Windows 8.1 (64-bit)
- Windows 10 (64 bit)



# Chapter 6

## VGA Setup

## 6.1 Introduction

To benefit from the Intel® Celeron™ N3710/N3160/N3010 integrated graphics controller, users must install the graphics driver.

## 6.2 Windows 7/8.1/10

**Note!** Before installing this driver, ensure the CSI utility is installed on the system. See Chapter 5 for information regarding installing the CSI utility.



Download the driver from website on your computer. Navigate to the "Graphics" folder and click "setup.exe" to complete the installation of the drivers for Windows 7, Windows 8.1 and Windows 10.

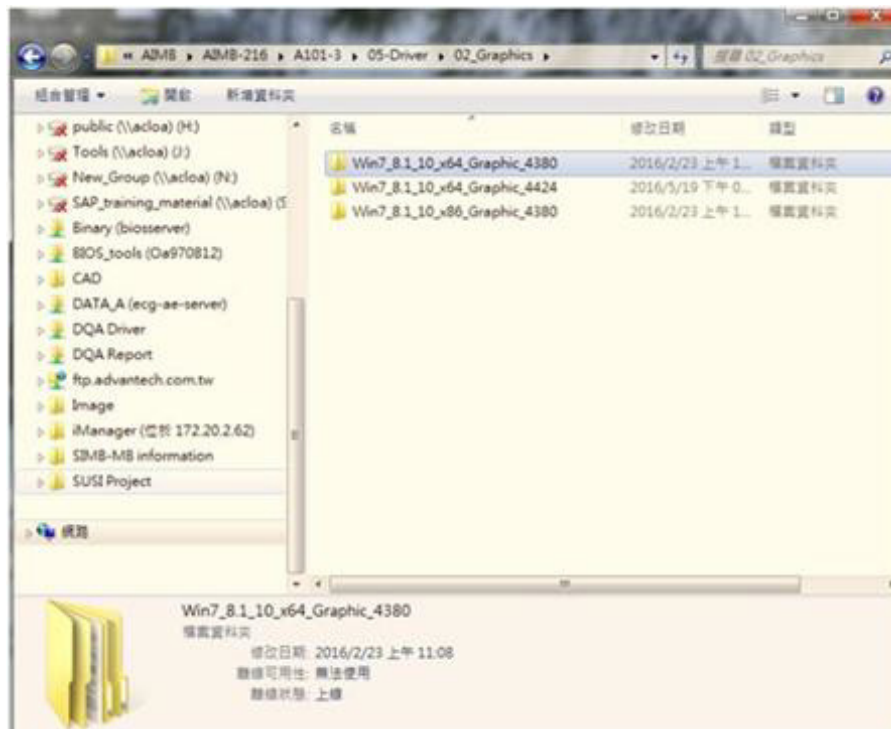

# Chapter 7

## LAN Configuration

## 7.1 Introduction

The AIMB-216 system features dual Gigabit Ethernet LANs via dedicated PCI Express x1 lanes (Realtek RTL8111G (LAN1) and Realtek RTL8111G (LAN2)) that offer a bandwidth of up to 500 MB/sec, eliminating bottlenecks in the flow of network data by incorporating Gigabit Ethernet at 1000 Mbps.

## 7.2 Features

- Integrated 10/100/1000 Mbps transceiver
- 10/100/1000 Mbps triple-speed MAC
- High-speed RISC core with 24-KB cache
- On-chip voltage regulation
- Wake-on-LAN (WOL) support
- PCI Express X1 host interface

## 7.3 Installation

**Note!** Before installing LAN drivers, ensure the CSI utility is installed on the system. See Chapter 5 for information regarding installing the CSI utility.



The Realtek 8111G (LAN1) and Realtek 8111G (LAN2) Gigabit integrated controllers support all major network operating systems. However, the installation procedure varies between systems. Please follow the driver setup procedure instructions specific to the operating system installed.

## 7.4 Windows 7/8.1/10 Driver Setup (Realtek 8111G)

Insert the driver CD into the system CD-ROM drive, open the LAN folder, and then navigate to the directory for the correct OS.

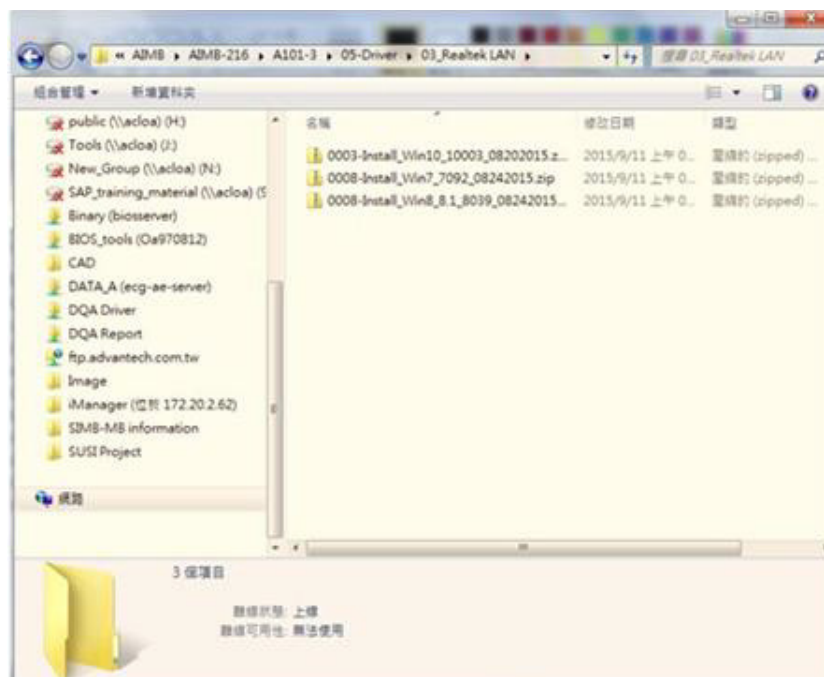

# Chapter 8

XHCI Driver  
Installation for USB  
Setup

## 8.1 Introduction

Intel N3710/N3160/N3010 only has XHCI USB controller for all of USB 2.0 / 3.0 ports. So, if your OS is Win 7, you need to install a USB 3.0 driver manually first. Before you install a USB 3.0 driver, the USB ports should not be in use. Please make sure you connect a PS/2 keyboard mouse to install the drivers first.

For Win8.1 OS, the inbox driver enables the USB controller to work automatically. You still can download and update the Win8.1 USB 3.0 driver from the website.

<http://support.advantech.com/Support/>

## 8.2 Installation

**Note!** If your OS is Win 7, you need to install a USB 3.0 driver manually first.



Download USB 3.0 driver from website to your computer. Click “USB 3.0” folder and chose WIN7 or WIN8.1 for the driver installation. Follow the instructions.

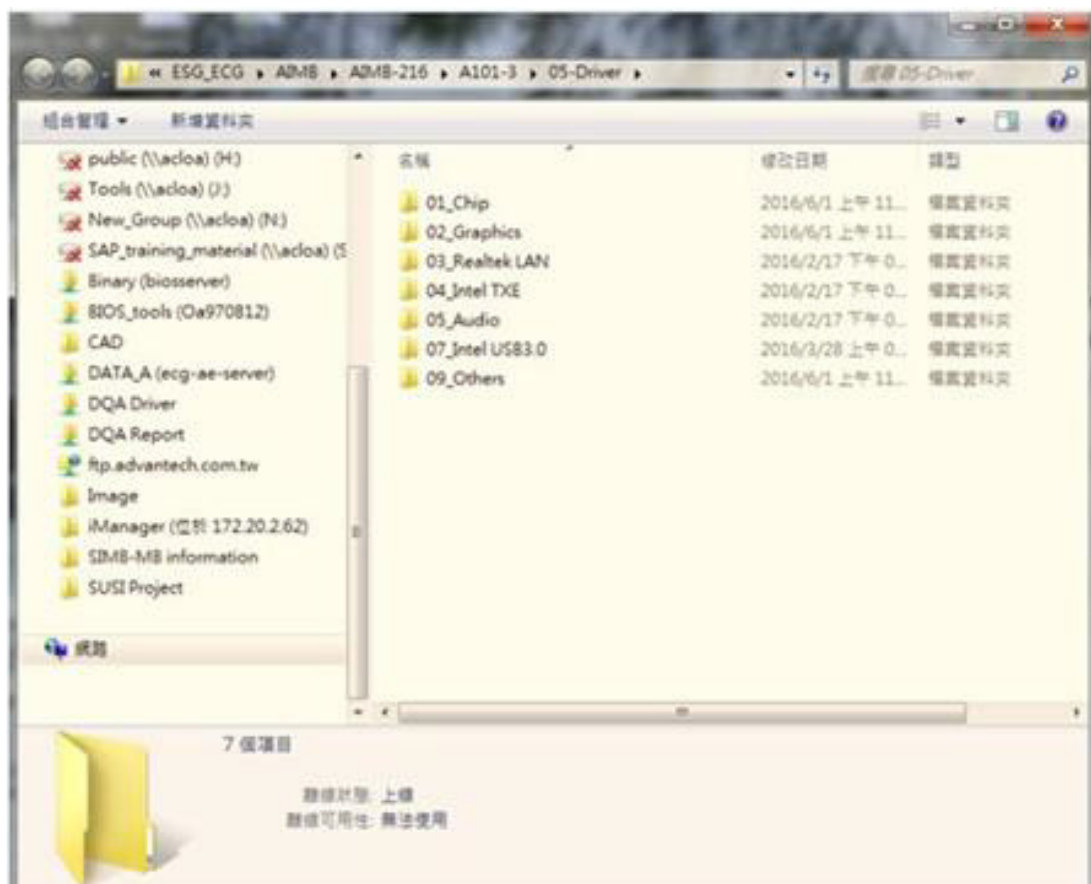

# Appendix **A**

Programming the  
Watchdog Timer

---

## A.1 Programming the Watchdog Timer

The AIMB-215 B1 watchdog timer can be used to monitor system software operations and execute corrective actions if the software fails to function within the programmed period. The operations and procedures for programming the watchdog timer are described in this section.

### A.1.1 Watchdog Timer Overview

The watchdog timer is built into the NCT6106D super I/O controller, and facilitates the following user-programmable functions:

- Can be enabled and disabled via a user program
- The timer interval can be set as 1 to 255 seconds or 1 to 255 minutes
- Generates an interrupt or reset signal if the software fails to reset the timer before timeout

### A.1.2 Programming the Watchdog Timer

The I/O port base addresses for the watchdog timer are 2E (hex) and 2F (hex), where 2E (hex) is the address port, and 2F (hex) is the data port. Users must first assign register addresses by inputting an address value into address port 2E (hex) before writing/reading data to/from the assigned register through data port 2F (hex).



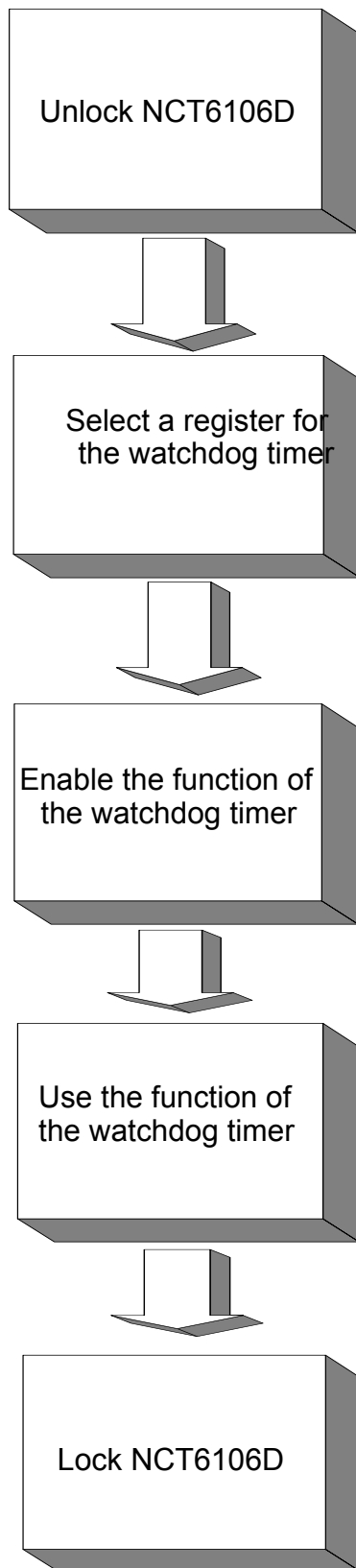

**Table A.1: Watchdog Timer Registers**

<b>Register Address (2E)</b>	<b>Attribute</b>	
Read/Write	Value (2F) and description	
87 (hex)	-----	Write this address to I/O address port 2E (hex) twice to unlock NCT6106D.
07 (hex)	write	Write 08 (hex) to the selected watchdog timer register.
30 (hex)	write	Write 01 (hex) to enable the function of the watchdog timer. The default setting is "Disabled".
F0 (hex)	write	Set the timer unit as seconds or minutes. Write 0 to bit 3: set the unit of measurement as seconds (default). Write 1 to bit 3: set the unit of measurement as minutes.
F1 (hex)	write	0: stop timer (default) 01~FF (hex): The timer value, in seconds or minutes, depends on the value set in Register F5 (hex). This value determines how long the watchdog timer waits for the strobe before generating an interrupt or reset signal. Writing a new value to this register resets the timer to count using the new value.
F2 (hex)	read/write	Bit 7: Write 1 to enable the mouse to reset the timer, or 0 to disable this function (default). Bit 6: Write 1 to enable the keyboard to reset the timer, or 0 to disable this function (default). Bit 5: Write 1 to immediately generate a timeout signal before automatically returning to 0 (default = 0). Bit 4: Read the watchdog timer status, 1 means the timer has reach timeout.
AA (hex)	-----	Write this address to I/O port 2E (hex) to lock the watchdog timer.

### A.1.3 Example Program

1. Enable the watchdog timer and set the timeout interval as 10 seconds

```

;-----
Mov dx,2eh; unlock NCT6106D
Mov al,87h
Out dx,al
Out dx,al
;-----
Mov al,07h; select the watchdog timer registers
Out dx,al
Inc dx
Mov al,08h
Out dx,al
;-----
Dec dx; enable the watchdog timer function
Mov al,30h
Out dx,al
Inc dx
Mov al,01h
Out dx,al
;-----
Dec dx; set the unit of measurement as seconds
Mov al,0f0h
Out dx,al
Inc dx
In al,dx
And al,not 08h
Out dx,al
;-----
Dec dx; set the timeout interval as 10 seconds and start counting
Mov al,0f1h
Out dx,al
Inc dx
Mov al,10
Out dx,al
;-----
Dec dx; lock NCT6106D
Mov al,0aah
Out dx,al

```

2. Enable the watchdog timer and set the timeout interval as 5 minutes

```

;-----
Mov dx,2eh; unlock NCT6106D
Mov al,87h
Out dx,al
Out dx,al

```

```

;-----
Mov al,07h; select the watchdog timer registers
Out dx,al
Inc dx
Mov al,08h
Out dx,al
;-----
Dec dx; enable the watchdog timer function
Mov al,30h
Out dx,al
Inc dx
Mov al,01h
Out dx,al
;-----
Dec dx; set the unit of measurement as minutes
Mov al,0f0h
Out dx,al
Inc dx
In al,dx
Or al,08h
Out dx,al
;-----
Dec dx; set the timeout interval as 5 minutes and start counting
Mov al,0f1h
Out dx,al
Inc dx
Mov al,5
Out dx,al
;-----
Dec dx; lock NCT6106D
Mov al,0aah
Out dx,al
3. Enable the watchdog timer to be reset using a mouse
;-----
Mov dx,2eh; unlock NCT6106D
Mov al,87h
Out dx,al
Out dx,al
;-----
Mov al,07h; select the watchdog timer registers
Out dx,al
Inc dx
Mov al,08h
Out dx,al
;-----

```

```

Dec dx; enable the watchdog timer function
Mov al,30h
Out dx,al
Inc dx
Mov al,01h
Out dx,al
;-----
Dec dx; enable the watchdog timer to be reset using a mouse
Mov al,0f2h
Out dx,al
Inc dx
In al,dx
Or al,80h
Out dx,al
;-----
Dec dx; lock NCT6106D
Mov al,0aah
Out dx,al
4. Enable the watchdog timer to be reset using a keyboard
;-----
Mov dx,2eh; unlock NCT6106D
Mov al,87h
Out dx,al
Out dx,al
;-----
Mov al,07h; select the watchdog timer registers
Out dx,al
Inc dx
Mov al,08h
Out dx,al
;-----
Dec dx; enable the watchdog timer function
Mov al,30h
Out dx,al
Inc dx
Mov al,01h
Out dx,al
;-----
Dec dx; enable the watchdog timer to be strobed reset using a keyboard
Mov al,0f2h
Out dx,al
Inc dx
In al,dx
Or al,40h
Out dx,al

```

```

;-----
Dec dx; lock NCT6106D
Mov al,0aah
Out dx,al
5. Generate a timeout signal without the timer counting
;-----
Mov dx,2eh; unlock NCT6106D
Mov al,87h
Out dx,al
Out dx,al
;-----
Mov al,07h; select the watchdog timer registers
Out dx,al
Inc dx
Mov al,08h
Out dx,al
;-----
Dec dx; enable the watchdog timer function
Mov al,30h
Out dx,al
Inc dx
Mov al,01h
Out dx,al
;-----
Dec dx; generate a timeout signal
Mov al,0f2h
Out dx,al; write 1 to Bit 5 of Register F7
Inc dx
In al,dx
Or al,20h
Out dx,al
;-----
Dec dx; lock NCT6106D
Mov al,0aah
Out dx,al

```







# Appendix **B**

I/O Pin Assignments

## B.1 ATX Power Supply (5VSB) Connector (ATX\_5V1)

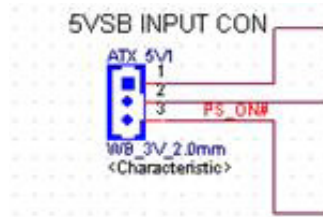

Table B.1: ATX\_5V1

PIN	PIN_NAME
1	+5VSB_IN
2	GND
3	PS_ON#

## B.2 eDP Connector (eDP1), BOM optional

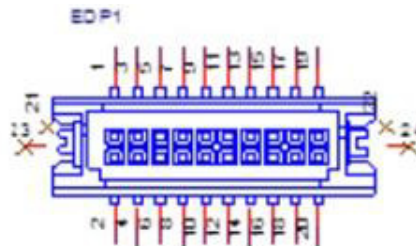

Table B.2: eDP1

PIN	PIN_NAME
1	EDP_DET_R
2	GND
3	EDP_TX0_C_N
4	EDP_TX3_C_N
5	EDP_TX0_C_P
6	EDP_TX3_C_P
7	GND
8	NC
9	EDP_TX1_C_N
10	GND
11	EDP_TX1_C_P
12	EDP_AUX1_C_N
13	GND
14	EDP_AUX1_C_P
15	EDP_TX2_C_N
16	GND
17	EDP_TX2_C_P
18	EDP_HPD_C
19	VDD_EDP
20	VDD_EDP

### B.3 LVDS2 Control Signal Pin Header (LVDS2), (BOM option)

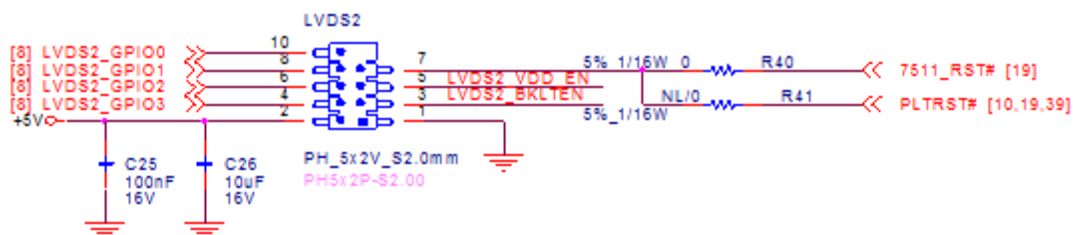

Table B.3: LVDS2

PIN	PIN_NAME
1	GND
2	+5V
3	LVDS2_BKLTEN
4	LVDS2_GPIO3
5	LVDS2_VDD_EN
6	LVDS2_GPIO2
7	LVDS_RESET
8	LVDS2_GPIO1
9	NC
10	LVDS2_GPIO0

### B.4 Inverter Power Connector (INV2), (BOM option)



Table B.4: INV2

PIN	PIN_NAME
1	+12V
2	GND
3	BL_EN_EDP
4	BL_CTL_EDP
5	+5V

## B.5 LVDS1 Control Signal Pin Header (LVDS1)

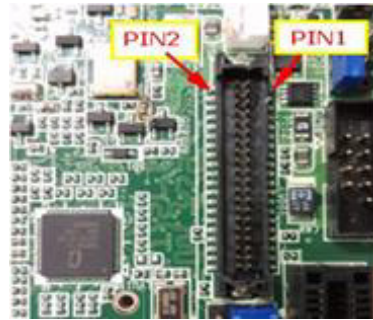
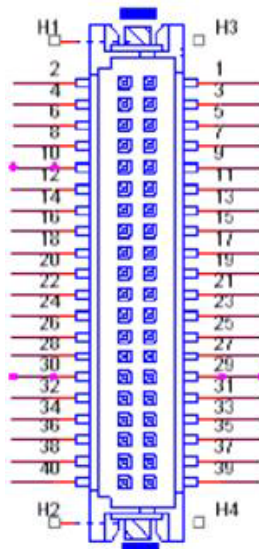

**Table B.5: LVDS1**

PIN	PIN_NAME
1	VDD_LVDS
2	VDD_LVDS
3	LVDS_DET#
4	GND
5	VDD_LVDS
6	VDD_LVDS
7	LVDSA_N0
8	LVDSB_N0
9	LVDSA_P0
10	LVDSB_P0
11	GND
12	GND
13	LVDSA_N1
14	LVDSB_N1
15	LVDSA_P1
16	LVDSB_P1
17	GND
18	GND
19	LVDSA_N2

Table B.5: LVDS1	
20	LVDSB_N2
21	LVDSA_P2
22	LVDSB_P2
23	GND
24	GND
25	LVDSA_CLK_N
26	LVDSB_CLK_N
27	LVDSA_CLK_P
28	LVDSB_CLK_P
29	GND
30	GND
31	LVDS_CH7511_DDC_CLK
32	LVDS_CH7511_DDC_DATA
33	GND
34	GND
35	LVDSA_N3
36	LVDSB_N3
37	LVDSA_P3
38	LVDSB_P3
39	LVDS_BL_EN
40	VCON

## B.6 Audio Amplifier Output Pin Header (JAMP1), (BOM option)

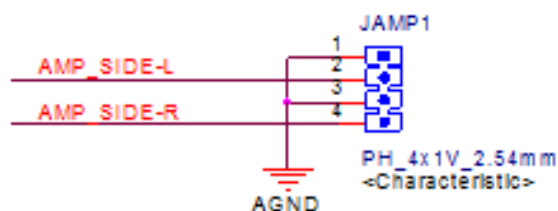

Table B.6: JAMP1	
PIN	PIN_NAME
1	GND
2	AMP_SIDE-L
3	GND
4	AMP_SIDE-R

## B.7 Front Panel Audio Connector (FP\_AUDIO1)

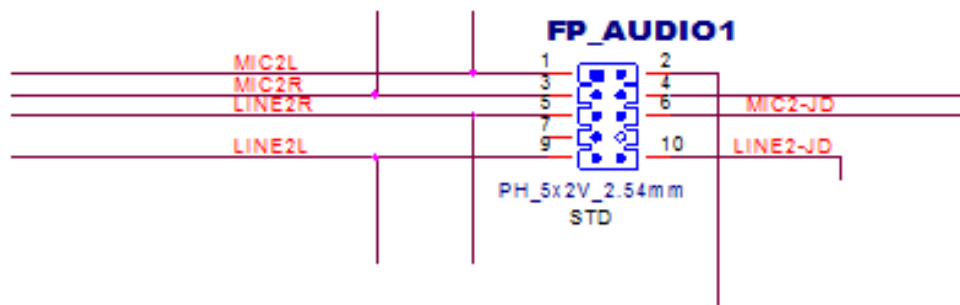

Table B.7: FP\_AUDIO1

PIN	PIN_NAME
1	MIC2L
2	AGND
3	MIC2R
4	Pull up to 3.3V
5	LINE2R
6	MIC2-JD
7	SENSEB
8	
9	LINE2L
10	LINE2-JD

## B.8 LVDS Backlight Inverter Power Connector (INV1)

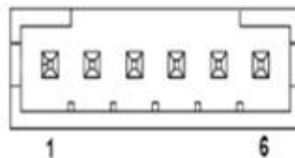

Table B.8: INV1

PIN	PIN_NAME
1	+12V
2	GND
3	BL_EN_LVDS
4	BL_CTL_LVDS
5	+5V

## B.9 SPDIF Interface Pin Header (SPDIF\_OUT1)

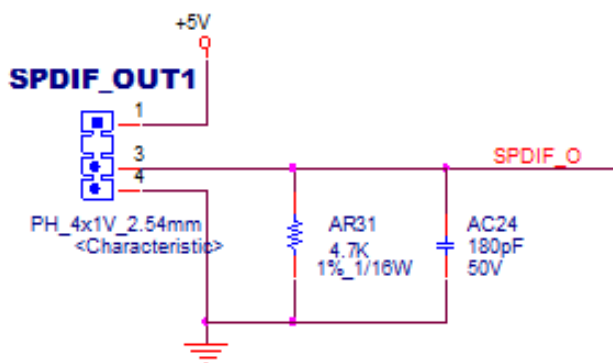

Table B.9: SPDIF\_OUT1

PIN	PIN_NAME
1	+5V
2	NC
3	SPDIF_O
4	GND

## B.10 COM1 Box Header (COM1)

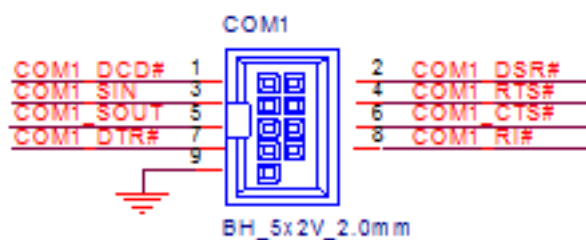
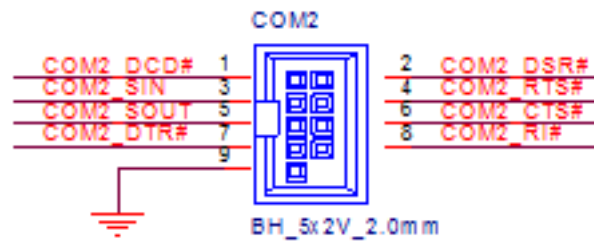

Table B.10: COM1

PIN	PIN_NAME
1	COM1_DCD#
2	COM1_DSR#
3	COM1_SIN
4	COM1_RTS#
5	COM1_SOUT
6	COM1_CTS#
7	COM1_DTR#
8	COM1_RI#
9	GND

## B.11 COM2 Pin Header (COM2)



**Table B.11: COM2**

PIN	PIN_NAME
1	COM2_DCD#
2	COM2_DSR#
3	COM2_SIN
4	COM2_RTS#
5	COM2_SOUT
6	COM2_CTS#
7	COM2_DTR#
8	COM2_RI#
9	GND

## B.12 USB2.0 Pin Header (USB0506)

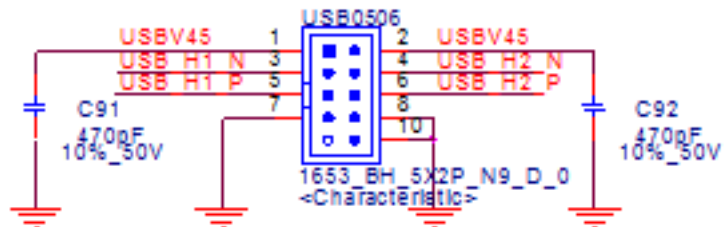

**Table B.12: USB0506**

PIN	PIN_NAME
1	USBV45
2	USBV45
3	USB_H1_N
4	USB_H2_N
5	USB_H1_P
6	USB_H2_P
7	GND
8	GND
10	GND



## B.13 USB2.0 Pin Header (USB0708), (BOM option)

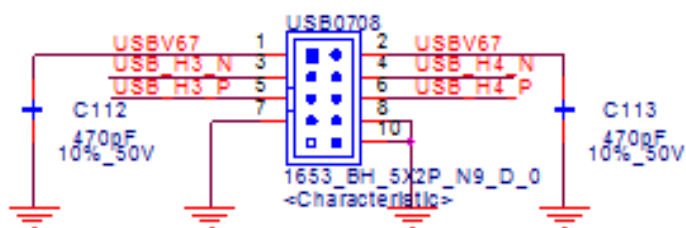

Table B.13: USB0708

PIN	PIN_NAME
1	USBV67
2	USBV67
3	USB_H3_N
4	USB_H4_N
5	USB_H3_P
6	USB_H4_P
7	GND
8	GND
10	GND

## B.14 COM3 ~ COM6 Box Header (COM3456)

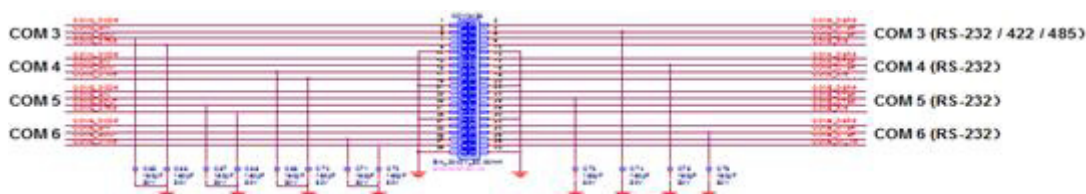

Table B.14: COM3456

PIN	PIN_NAME
1	COM3_DCD#
2	COM3_DSR#
3	COM3_SIN
4	COM3_RTS#
5	COM3_SOUT
6	COM3_CTS#
7	COM3_DTR#
8	COM3_RI#
9	GND
10	GND
11	COM4_DCD#
12	COM4_DSR#
13	COM4_SIN
14	COM4_RTS#
15	COM4_SOUT
16	COM4_CTS#

**Table B.14: COM3456**

17	COM4_DTR#
18	COM4_RI#
19	GND
20	GND
21	COM5_DCD#
22	COM5_DSR#
23	COM5_SIN
24	COM5_RTS#
25	COM5_SOUT
26	COM5_CTS#
27	COM5_DTR#
28	COM5_RI#
29	GND
30	GND
31	COM6_DCD#
32	COM6_DSR#
33	COM6_SIN
34	COM6_RTS#
35	COM6_SOUT
36	COM6_CTS#
37	COM6_DTR#
38	COM6_RI_V#
39	GND
40	GND

## B.15 SATA Power Connector (SATA\_PWR1/2)

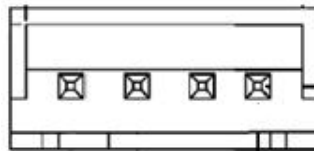
**Table B.15: SATA\_PWR1,SATA\_PWR2**

PIN	PIN_NAME
1	+5V
2	GND
3	GND
4	+12V

## B.16 Power LED and Keyboard Lock Pin Header (JFP3)

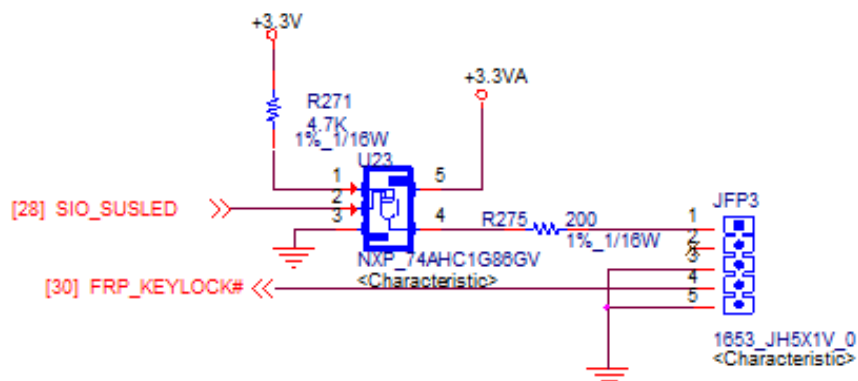

Table B.16: JFP3

PIN	PIN_NAME
1	POWER_LED+
2	NC
3	POWER_LED-
4	FRP_KEYLOCK#
5	GND

## B.17 General Purpose I/O Connector (GPIO1)

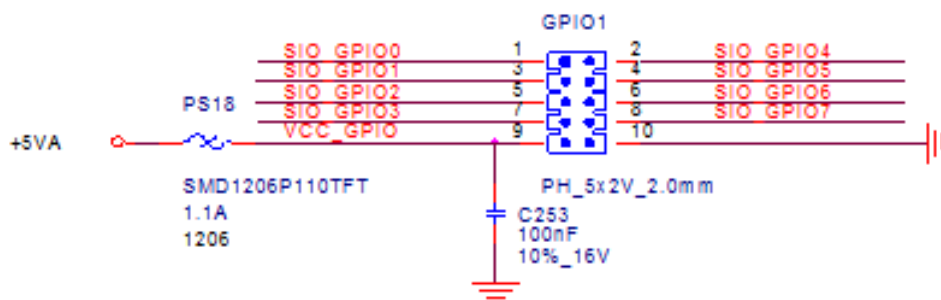
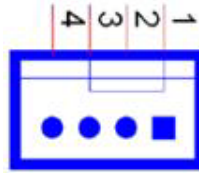

Table B.17: GPIO1

PIN	PIN_NAME
1	SIO_GPIO0
2	SIO_GPIO4
3	SIO_GPIO1
4	SIO_GPIO5
5	SIO_GPIO2
6	SIO_GPIO6
7	SIO_GPIO3
8	SIO_GPIO7
9	VCC_GPIO
10	GND

## B.18 CPU Fan and System Fan Connectors (CPUFAN1,SYSFAN1)



**Table B.18: CPUFAN1,SYSFAN1**

PIN	PIN_NAME
1	GND
2	VCC
3	FEEDBACK
4	PWM

## B.19 Front Panel Connectors (JFP1 + JFP2)

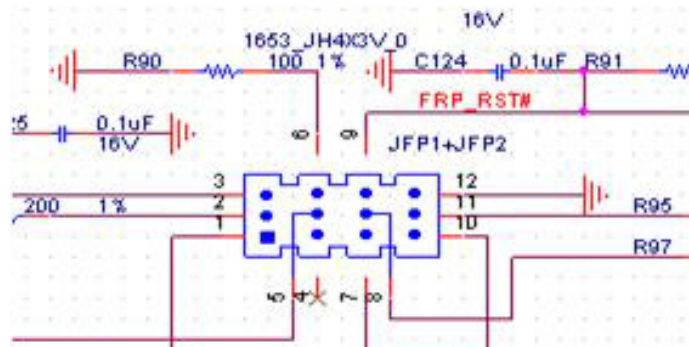

**Table B.19: JFP1+JFP2**

PIN	PIN_NAME
1	+5V
2	HDDLED+
3	Power Button+
4	NC
5	HDDLED-
6	Power Button-
7	SPK_P3
8	SMB_DATA
9	System Reset+
10	SPK_P4
11	SMB_CLK
12	System Reset-

## B.20 PS/2 Keyboard and PS/2 Mouse Connector (KBMS1)

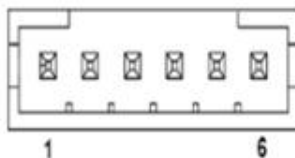

Table B.20: KBMS1

PIN	PIN_NAME
1	KB_b_CLK
2	KB_b_DAT
3	MS_b_CLK
4	GND
5	VCC_KBMS
6	MS_b_DAT

## B.21 USB2.0 Connector (USB0910), (BOM option)

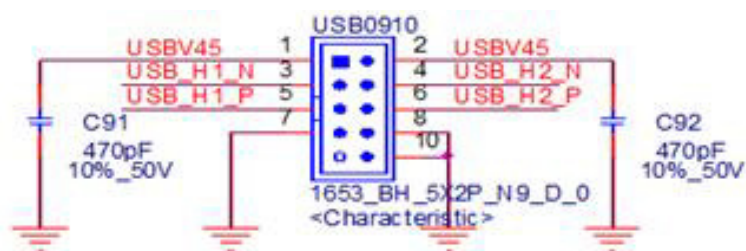

Table B.21: USB0910

PIN	PIN_NAME
1	USBV45
2	USBV45
3	USB_H1_N
4	USB_H2_N
5	USB_H1_P
6	USB_H2_P
7	GND
8	GND
10	GND

## B.22 Case Open Pin Header (JCASE1)

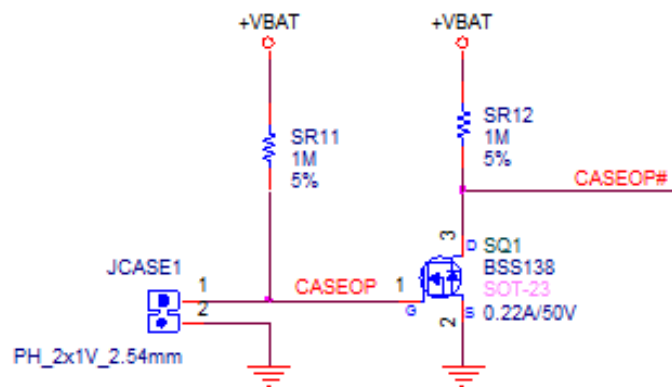

Table B.22: JCASE1

PIN	PIN_NAME
1	CASEOP
2	GND

## B.23 CMOS Battery Wafer Box (BAT1)

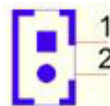

Table B.23: BAT1

PIN	PIN_NAME
1	VBAT
2	GND

## B.24 SPI BIOS Socket (SPI1\_1)

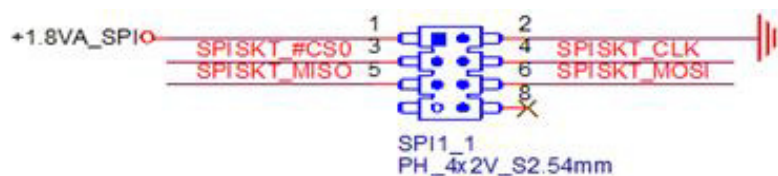
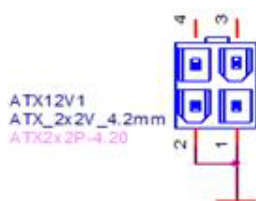

Table B.24: SPI1\_1

PIN	PIN_NAME
1	+1.8VA_SPI
2	GND
3	SPI SKT #CS0
4	SPI SKT CLK
5	SPI SKT MISO
6	SPI SKT MOSI
7	NC
8	GND

## B.25 ATX 12 V Power Supply Connector (ATX12V1)



**Table B.25: ATX12V1**

PIN	PIN_NAME
1	GND
2	GND
3	VDC_IN_C
4	VDC_IN_C

## B.26 HD Analog Audio Interface (AUDIO1)

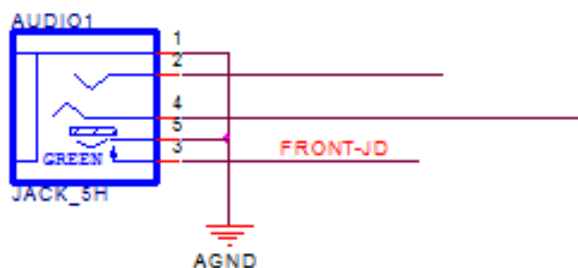

**Table B.26: AUDIO1**

PIN	PIN_NAME
1	AGND
2	LINEOL
3	FRONT-JD
4	LINEOR
5	AGND

## B.27 High Definition Connector (HDMI1)

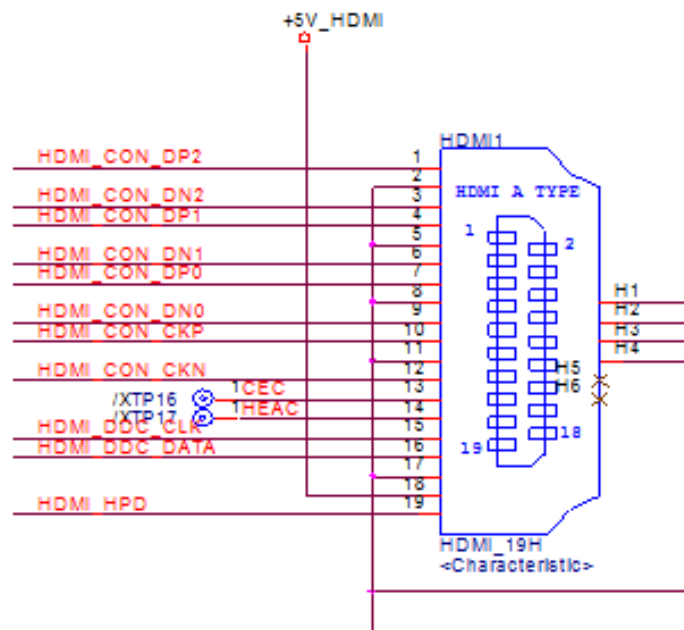
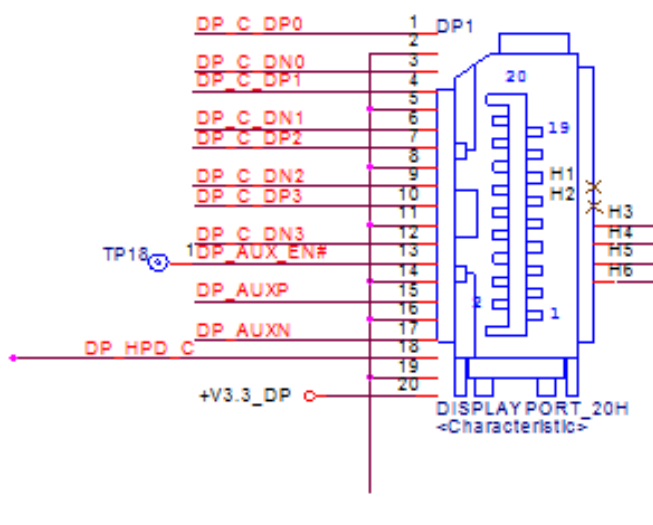

**Table B.27: HDMI1**

PIN	PIN_NAME
1	HDMI_CON_DP2
2	GND
3	HDMI_CON_DN2
4	HDMI_CON_DP1
5	GND
6	HDMI_CON_DN1
7	HDMI_CON_DP0
8	GND
9	HDMI_CON_DN0
10	HDMI_CON_CKP
11	GND
12	HDMI_CON_CKN
13	CEC
14	HEAC
15	HDMI_DDC_CLK
16	HDMI_DDC_DATA
17	GND
18	+5V_HDMI
19	HDMI_HPD



## B.28 Display Port Connector (DP1)



**Table B.28: DP1**

PIN	PIN_NAME
1	DP_C_DP0
2	GND
3	DP_C_DN0
4	DP_C_DP1
5	GND
6	DP_C_DN1
7	DP_C_DP2
8	GND
9	DP_C_DN2
10	DP_C_DP3
11	GND
12	DP_C_DN3
13	DP_AUX_EN#
14	GND
15	DP_AUXP
16	GND
17	DP_AUXN
18	DP_HPD_C
19	GND
20	+V3.3_DP

## B.29 Digital Visual Interface (DVI\_1)

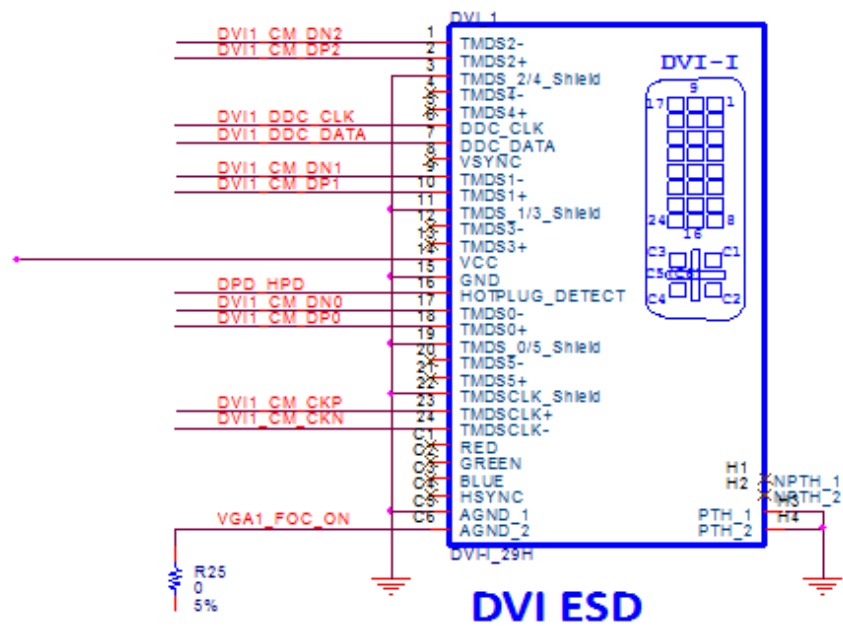

Table B.29: DVI\_1

PIN	PIN_NAME
1	DVI1_CM_DN2
2	DVI1_CM_DP2
3	GND
4	
5	
6	DVI1_DDC_CLK
7	DVI1_DDC_DATA
8	
9	DVI1_CM_DN1
10	DVI1_CM_DP1
11	GND
12	
13	
14	+5V_DVI
15	GND
16	DPD_HPD
17	DVI1_CM_DN0
18	DVI1_CM_DP0
19	GND
20	
21	
22	GND
23	DVI1_CM_CKP
24	DVI1_CM_CKN C1
C2	
C3	

**Table B.29: DVI\_1**

C4	
C5	GND
C6	VGA1_FOC_ON

**ADVANTECH**

*Enabling an Intelligent Planet*

**[www.advantech.com](http://www.advantech.com)**

Please verify specifications before quoting. This guide is intended for reference purposes only.

All product specifications are subject to change without notice.

No part of this publication may be reproduced in any form or by any means, electronic, photocopying, recording or otherwise, without prior written permission of the publisher.

All brand and product names are trademarks or registered trademarks of their respective companies.

© Advantech Co., Ltd. 2018