

ASMB-786

LGA 1151 Intel® Xeon® E/8th Gen Intel® Core™ Series ATX Server Board with DDR4, 7 x PCIe, 6 x USB 3.1, 8 x SATAIII, Quad/Dual LANs, and IPMI

Copyright

The documentation and the software included with this product are copyrighted 2018 by Advantech Co., Ltd. All rights are reserved. Advantech Co., Ltd. reserves the right to make improvements in the products described in this manual at any time without notice. No part of this manual may be reproduced, copied, translated, or transmitted in any form or by any means without the prior written permission of Advantech Co., Ltd. The information provided in this manual is intended to be accurate and reliable. However, Advantech Co., Ltd. assumes no responsibility for its use, nor for any infringements of the rights of third parties that may result from its use.

Acknowledgements

AMI is a trademark of American Megatrends Inc.

IBM and PC are trademarks of International Business Machines Corporation.

Intel® Xeon®, Core™ and Pentium® are trademarks of Intel® Corporation.

All other product names or trademarks are properties of their respective owners.

Product Warranty (2 years)

Advantech warrants the original purchaser that each of its products will be free from defects in materials and workmanship for two years from the date of purchase.

This warranty does not apply to any products that have been repaired or altered by persons other than repair personnel authorized by Advantech, or products that have been subject to misuse, abuse, accident, or improper installation. Advantech assumes no liability under the terms of this warranty as a consequence of such events.

Because of Advantech's high quality-control standards and rigorous testing, most customers never need to use our repair service. If an Advantech product is defective, it will be repaired or replaced free of charge during the warranty period. For out-of-warranty repairs, customers will be billed according to the cost of replacement materials, service time, and freight. Please consult your dealer for more details.

If you believe your product is defective, follow the steps outlined below.

1. Collect all the information about the problem encountered. (For example, CPU speed, Advantech products used, other hardware and software used, etc.) Note anything abnormal and list any onscreen messages displayed when the problem occurs.
2. Call your dealer and describe the problem. Please have your manual, product, and any helpful information readily available.
3. If your product is diagnosed as defective, obtain a return merchandise authorization (RMA) number from your dealer. This allows us to process your return more quickly.
4. Carefully pack the defective product, a completed Repair and Replacement Order Card, and a proof of purchase date (such as a photocopy of your sales receipt) into a shippable container. Products returned without a proof of purchase date are not eligible for warranty service.
5. Write the RMA number clearly on the outside of the package and ship the package prepaid to your dealer.

A Message to the Customer

Advantech Customer Services

Each Advantech product is built to the most precise specifications to ensure reliable performance in the harsh and demanding conditions typical of industrial environments. Whether your new Advantech equipment is destined for the laboratory or the factory floor, you can be assured that your product will provide the reliability and ease of operation for which the name Advantech is renowned.

Your satisfaction is our primary concern. Here is a guide to Advantech's customer services. To ensure you get the full benefit of our services, please follow the instructions below carefully.

Technical Support

We want you to get the maximum performance from your products. If you experience technical difficulties, we are here to help. For the most frequently asked questions, you can easily find answers in your product documentation. These answers are normally a lot more detailed than the ones provided over the phone.

So please consult this manual first. If you still cannot find the answer, gather all the information or questions that apply to your problem, and with the product close at hand, call your dealer. Our dealers are well trained and ready to give you the support needed to get the most from your Advantech products. In fact, most problems reported are minor and are easily solved over the phone.

In addition, free technical support is available from Advantech engineers every business day. We are always ready to give advice on application requirements or specific information regarding the installation and operation of any of our products.

Declaration of Conformity

FCC

This device complies with the requirements in part 15 of the FCC rules.

Operation is subject to the following two conditions:

- This device may not cause harmful interference
- This device must accept any interference received, including interference that may cause undesired operation.

This equipment has been tested and found to comply with the limits for a Class B digital device, pursuant to Part 15 of the FCC Rules. These limits are designed to provide reasonable protection against harmful interference when the equipment is operated in a commercial environment. This equipment generates, uses, and can radiate radio frequency energy and, if not installed and used in accordance with the instruction manual, may cause harmful interference to radio communications. Operation of this device in a residential area is likely to cause harmful interference. In this event, users are required to correct the interference at their own expense. Users are also advised that any equipment changes or modifications not expressly approved by the party responsible for compliance would void compliance with FCC regulations and, therefore, the user's authority to operate the equipment.

Caution! *Batteries are at risk of exploding if incorrectly installed. Do not attempt to recharge, force open, or heat the battery. Replace the battery only with the same or equivalent type as recommended by the manufacturer. Discard used batteries according to the manufacturer's instructions.*



Ordering Information

Part Number	Chipset	Memory	LAN	Display	IPMI
ASMB-786G4-00A1	C246	DDR4 288-pin ECC/non-ECC unbuffered DIMM	4	DVI, HDMI, VGA	Yes (AST-2400 onboard)
ASMB-786G2-00A1	C246	DDR4 288-pin ECC/non-ECC unbuffered DIMM	2	DVI, HDMI, VGA	-

Packing List

Before motherboard installation, ensure that the following items are included in your shipment:

- 1 x Startup manual
- 2 x Serial ATA HDD data cables (including 1 x right angle cable)
- 2 x Serial ATA HDD power cables
- 1 x COM cable for I/O port bracket
- 1 x I/O port bracket
- 1 x Warranty card

If any of these items are missing or damaged, contact your distributor or sales representative immediately. We have carefully inspected ASMB-786 mechanically and electrically before shipment. The product should be free of marks and scratches and in perfect working order upon receipt. When unpacking ASMB-786, check the product for signs of shipping damage (for example, damaged box, scratches, dents, etc.). If the product is damaged or fails to meet the specifications, notify our service department or your local sales representative immediately. Also notify the carrier. Retain the shipping carton and packing material for inspection by the carrier. After inspection, we will make arrangements to repair or replace the unit.

Contents

Chapter	1	Hardware Configuration	1
1.1		Introduction	2
1.2		Features	2
1.3		Specifications	3
	1.3.1	CPU	3
	1.3.2	PCH	3
	1.3.3	Memory	3
	1.3.4	Input/Output	3
	1.3.5	Graphics	4
	1.3.6	Ethernet LAN	4
	1.3.7	Industrial Features	4
	1.3.8	Mechanical and Environmental Specifications	4
1.4		Jumpers and Connectors	5
		Table 1.1: Jumper List	5
		Table 1.2: Connector List	5
1.5		Jumper and Connector Locations	7
		Figure 1.1 Jumper and Connector Locations	7
		Figure 1.2 I/O Connectors (G4 SKU)	7
	1.5.1	Onboard LAN LED Definition	8
		Table 1.3: Onboard LAN LED Definition	8
	1.5.2	Onboard LEDs (LED2, LED3, and LED4)	8
		Table 1.4: Onboard LEDs (LED2, LED3, and LED4)	8
1.6		ASMB-786 Block Diagram	9
		Figure 1.3 ASMB-786 Block Diagram	9
1.7		Safety Precautions	10
1.8		Jumper Settings	10
	1.8.1	How to Set Jumpers	10
		Table 1.5: CMOS Clear (JCMOS1)	11
		Table 1.6: ME Update (JME1)	11
		Table 1.7: Watchdog Timer Output (JWDT1)	11
		Table 1.8: USB Power Switch (JUSB1/JUSB2)	12
		Table 1.9: Fan Mode Selection (CPUFAN_SEL1, SYSFAN_SEL1)	12
		Table 1.10: ATX/AT Mode Selector (PSON1)	13
		Table 1.11: PCIe Link Switch (JPEG1, JPEG2)	13
1.9		System Memory	14
Chapter	2	Connecting Peripherals	15
2.1		Introduction	16
2.2		USB Ports (LAN1_USB1_2, LAN2_USB3_4, USB5~13)	16
2.3		USB Power Switch (JUSB1, JUSB2)	17
2.4		Display Connector (HDMI1_VGA1, DVI1)	18
2.5		Serial Ports (COM1 ~ COM2)	19
2.6		External Keyboard and Mouse (KBMS1)	20
2.7		CPU Fan Connector (CPUFAN0)	21
2.8		System FAN Connector (SYSFAN0 ~ SYSFAN3)	22
2.9		Front Panel Connectors (JFP1, 2, 3)	23
	2.9.1	Power LED (JFP3 Pins 1, 3)	24
	2.9.2	External Speaker (JFP2 Pins 1, 4, 7, 10)	24
	2.9.3	HDD LED Connector (JFP1 Pins 2, 5)	24
	2.9.4	SNMP SMBus Connector (JFP2 Pins 8, 11)	24
	2.9.5	ATX Soft Power Switch (JFP1 Pins 3, 6)	24
	2.9.6	Reset Connector (JFP1 Pins 9, 12)	24

2.10	Alarm Board Connector (VOLT1).....	25
2.11	Case Open Connector (JCASE1).....	26
2.12	Front Panel LAN Indicator Connector (LANLED1).....	27
2.13	Serial ATA Interface (SATA0 ~ 7).....	28
2.14	PCIe x16 Expansion Slots	29
2.15	PCIe x4 Expansion Slots (PCIEx4_Slot2, 7).....	31
2.16	PCIe x1 Expansion Slots (PCIEx1_Slot1, 3, 5).....	32
2.17	Auxiliary Power Connector (ATX12V1).....	33
2.18	SPI Flash Connector (SPI_CN1).....	34
2.19	Low-Pin-Count Connector (LPC1).....	35
2.20	Parallel Port (LPT1).....	36
2.21	PMBUS Connector (PMBUS1).....	37

Chapter 3 BIOS Operation 39

3.1	Introduction	40
	Figure 3.1 Main BIOS Setup Screen	40
3.2	Entering BIOS Setup.....	41
3.2.1	Main Menu.....	41
	Figure 3.2 Main BIOS Setup Screen	41
3.2.2	System Time/System Date	41
3.3	Advanced BIOS Features	42
	Figure 3.3 Advanced Tab of the BIOS Setup Screen.....	42
3.3.1	Platform Misc Configuration.....	43
	Figure 3.4 Platform Misc Configuration Screen.....	43
3.3.2	CPU Configuration.....	44
	Figure 3.5 CPU Configuration Screen	44
3.3.3	Power and Performance.....	45
	Figure 3.6 CPU - Power Management Control Screen	45
3.3.4	PCH-FW Configuration.....	46
	Figure 3.7 PCH-FW Configuration Screen	46
3.3.5	Trusted Computing	54
	Figure 3.8 TPM Settings Screen	54
3.3.6	ACPI Settings	55
	Figure 3.9 ACPI Settings Screen.....	55
3.3.7	SMART Settings.....	56
	Figure 3.10 SMART Settings Screen	56
3.3.8	COM1/2 Configuration	57
	Figure 3.11 COM1/2 Configuration Screen	57
3.3.9	NCT6776 HW Monitor	60
	Figure 3.12 PC Health Status Screen	60
3.3.10	PCA-COM232/COM485 Super I/O Configuration.....	63
	Figure 3.13 PCA-COM Configuration Screen.....	63
3.3.11	Serial Port Console Redirection.....	65
	Figure 3.14 Serial Port Console Redirection Screen.....	65
3.3.12	Intel® Trusted Execution Technology (TXT) Information.....	68
	Figure 3.15 Intel® TXT Information Screen.....	68
3.3.13	PCI Subsystem Settings	69
	Figure 3.16 PCI Subsystem Settings Screen	69
3.3.14	USB Configuration	70
	Figure 3.17 USB Configuration Screen	70
3.3.15	UEFI Network Stack Configuration	73
	Figure 3.18 UEFI Network Stack Configuration Screen	73
3.3.16	CSM Configuration	74
	Figure 3.19 CSM Configuration Screen.....	74
3.4	Chipset.....	79
	Figure 3.20 Chipset Configuration Screen	79
3.4.1	System Agent (SA) Configuration.....	79
	Figure 3.21 SA Configuration Screen.....	79

3.4.2	PCH-IO Configuration	84
	Figure 3.22 PCH-IO Configuration Screen	84
	Figure 3.23 PCI Express Configuration Screen	86
	Figure 3.24 SATA and RST Configuration Screen	87
	Figure 3.25 USB Configuration Screen	88
	Figure 3.26 Security Configuration Screen	89
	Figure 3.27 HD Audio Configuration Screen	90
3.5	Security	91
	Figure 3.28 Security Configuration Screen	91
3.6	Boot	92
	Figure 3.29 Boot Configuration Screen	92
3.7	Save and Exit	93
	Figure 3.30 Save and Exit Screen	93
3.8	Server Management	94
	Figure 3.31 Server Management Screen	94
3.8.1	System Event Log	96
3.8.2	BMC Self-Test Log	98
3.8.3	BMC Network Configuration	99

Chapter 4 Driver Installation101

4.1	Before Installation	102
4.2	Introduction	102
4.2.1	Chipset	102
4.2.2	Graphics	103
4.2.3	LAN	103
4.2.4	HD Audio	103
4.2.5	Intel® ME	103
4.2.6	SATA RAID	104

Appendix A Watchdog Timer105

A.1	Watchdog Timer Overview	106
A.2	Programming the Watchdog Timer	106
	Table A.1: Watchdog Timer Registers	108
A.2.1	Example Programs	108

Appendix B I/O Pin Assignments113

B.1	USB 2.0 Header (USB7 ~ 12)	114
	Table B.1: USB 2.0 Header (USB7 ~ 12)	114
B.2	USB 3.1 Header (USB5_6)	114
	Table B.2: USB 3.1 Header (USB5_6)	114
B.3	VGA Connector (VGA1)	115
	Table B.3: VGA Connector (VGA1)	115
B.4	RS-232 Interface (COM1 ~ 2)	115
	Table B.4: RS-232 Interface (COM1 ~ 2)	115
B.5	External Keyboard/Mouse Connector (KBMS1)	116
	Table B.5: External Keyboard/Mouse Connector (KBMS1)	116
B.6	System Fan Power Connector (SYSFAN0 ~ 3)	116
	Table B.6: System Fan Power Connector (SYSFAN0 ~ 3)	116
B.7	Power LED and Keyboard Lock (JFP3)	116
	Table B.7: Power LED and Keyboard Lock (JFP3)	116
B.8	External Speaker Connector (JFP2)	117
	Table B.8: External Speaker Connector (JFP2)	117
B.9	HDD LED Connector (JFP2)	117
	Table B.9: HDD LED Connector (JFP2)	117
B.10	SNMP SMBus Connector (JFP2)	117

	Table B.10:SNMP SMBus Connector (JFP2).....	117
B.11	ATX Soft Power Switch (JFP1).....	118
	Table B.11:ATX Soft Power Switch (JFP1)	118
B.12	Reset Connector (JFP1)	118
	Table B.12:Reset Connector (JFP1).....	118
B.13	Front Panel Audio Connector (FPAUD1).....	118
	Table B.13:Front Panel Audio Connector (FPAUD1)	118
B.14	8-Pin Alarm Board Connector (VOLT1)	119
	Table B.14:8-Pin Alarm Board Connector (VOLT1).....	119
B.15	Case Open Connector (JCASE1)	119
	Table B.15:Case Open Connector (JCASE1).....	119
B.16	Front Panel LAN LED Connector (LAN_LED1)	119
	Table B.16:LAN LED Connector (LANLED1)	119
B.17	SPI Flash Card Pin Connector (SPI_CN1)	120
	Table B.17:SPI Flash Connector (SPI_CN1).....	120
B.18	GPIO Connector (GPIO1).....	120
	Table B.18:GPIO Connector (GPIO1)	120
B.19	SMBUS Connector (SMBUS1)	120
	Table B.19:SMBUS Connector (SMBUS1).....	120
B.20	PMBUS Connector (PMBUS1)	121
	Table B.20:PMBUS Connector (PMBUS1).....	121
B.21	Parallel Port (LPT1)	121
	Table B.21:Parallel Port (LPT1).....	121
B.22	System I/O Ports.....	122
	Table B.22:System I/O Ports	122
B.23	Interrupt Assignments	122
	Table B.23:Interrupt Assignments	122
B.24	First Motherboard Memory Map.....	123
	Table B.24:First Motherboard Memory Map	123

Chapter 1

Hardware
Configuration

1.1 Introduction

The ASMB-786 motherboard is equipped with the most advanced Intel® C246 chipset for industrial server applications that require high-performance computing. The motherboard supports Intel® Xeon® E/8th Gen Intel® Core™ processors with up to 64 GB of DDR4 (288-pin) 2666/2400/2133 MHz ECC/non-ECC memory. ASMB-786 also provides cost-effective Intel HD graphics integrated on the processor. The graphics VRAM features 1 GB of shared memory with at least 2 GB of system memory installed.

To satisfy diverse video surveillance and factory automation requirements, ASMB-786 offers up to seven Gen3 PCIe slots (including one PCIe x16 slot with a x16 link or two PCIe x16 slots with a x8 link) via the processor, as well as two PCIe x4 and three PCIe x1 slots via the Intel® C246 platform controller hub (PCH). Additionally, ASMB-786 provides up to four Gigabit Ethernet LAN via a dedicated PCIe bus with up to 500 MB/s bandwidth, thereby eliminating network bottlenecks.

With the inclusion of an Intel® C246 chipset, ASMB-786 also supports eight onboard SATA III interfaces (bandwidth = 600 MB/s) with software RAID, six USB 3.1 ports, and seven USB 2.0 ports. These powerful I/O capabilities ensure reliable data storage and high-speed I/O peripheral connectivity.

The ASMB-786 motherboard is also equipped with Advantech's unique, patented sleep mode control circuit for AT Power mode. Considering all its excellent features and capabilities, ASMB-786 provides the ideal high-performance platform for industrial applications.

1.2 Features

- **Triple Display:** One VGA, one DVI-D, and one HDMI port, with support for three simultaneous display outputs.
- **PCIe Architecture:** One PCIe x16 (x16 link) or two PCIe x16 (x8 link) slots via the processor, as well as two PCIe x4 (x4 link) and three PCIe x1 slots (x1 link) via the Intel® C246 PCH.
- **High-Performance I/O:** Quad or dual Gigabit LAN via the PCIe bus, six USB 3.1 (four Gen2 plus two Gen1) ports, and seven USB 2.0 ports (including one Type A port), and eight SATA III connectors.
- **Standard ATX Form Factor with Industrial-Grade Features:** Long product life, wide operating temperature range, and watchdog timer functions.
- **Automatic Power On After Power Failure:** Power resume after a system power failure. Advantech's industrial server board allows users to set the system to power on automatically. (Refer to Section 1.8.1.6 "ATX/AT mode selector" for additional details.)
- **Active Management Technology:** The hardware and firmware base solution is powered by the system auxiliary power plane to facilitate remote monitoring of networked systems. Intel® Active Management Technology (iAMT) stores hardware and software information in non-volatile memory. Built-in management provides out-of-band management capabilities, allowing remote discovery and KVM to repair systems after OS failures. Alert and event logging features detect problems and reduce system downtime by pro-actively blocking incoming threats, quarantining infected clients, and notifying users when critical software agents are removed. To enable iAMT, refer to Section 3.3.4.1 "AMT Configuration" in the BIOS Operation chapter.

1.3 Specifications

1.3.1 CPU

- Supports Intel® Xeon® E Series and 8th Gen Intel® Core™ i3/i5/i7 processors via an LGA1151 socket
- Supports 95 W max. TPD

Note! *This platform only supports Windows 10 (64 bit) and Windows Server 2016 (64 bit).*



1.3.2 PCH

- **System Chipset:** Intel® C246
- **SATA HDD Interface:** Eight on-board SATA III connectors support Advanced Host Controller Interface (AHCI) technology and Intel Rapid Storage Technology enterprise (RSTe) for software RAID 1, 0, 10, and 5 with data transmission rates of up to 600 MB/s

1.3.3 Memory

- **RAM:** Up to 64 GB in four 288-pin DIMM sockets; supports dual-channel DDR4 ECC/non-ECC 2666/2400/2133 unbuffered DIMM

Note! *1. Because of the inherent limitations of the PC architecture, the system may not detect the full 64 GB of RAM when 64 GB RAM is installed.*



2. A 32-bit OS may not detect the full 4 GB of RAM when 4 GB is installed.

1.3.4 Input/Output

- **PCIe (Gen3):** One PCIe x16 expansion slot with a x16 link or two PCIe x16 expansion slots with a x8 link, plus two PCIe x4 slots with a x4 link, and three PCIe x1 slots with a x1 link.
- **Enhanced Parallel Port:** Configured to LPT1 by default. LPT1 supports EPP/SPP/ECP. Standard DB-25 female connector cable is optional.
- **Serial Port:** Two serial port onboard headers (one can be used for the rear I/O port bracket via a COM cable connection), support only RS-232.
- **PS/2 Keyboard and Mouse Connector:** To save rear I/O space, ASMB-786 features a reserved 6-pin header onboard (KBMS1) that can be used to build two 6-pin mini-DIN connectors for easy connection to a PS/2 keyboard and mouse.
- **USB:** Six USB 3.1 ports that support data transmission speeds of up to 10 Gbps and 7 USB 2.0 ports that support transmission speeds of up to 480 Mbps.
- **LPC:** One LPC connector supports Advantech TPM LPC modules and COM 232/422/485 modules.
- **GPIO:** ASMB-786 supports 8-bit GPIO super I/O for general-purpose control applications.

Note!  ASMB-786 features an onboard KBMS1 connector for external keyboard/mouse usage. Please purchase an optional PS/2 keyboard/mouse cable (P/N:1700019268-11) and bracket (P/N:1960063434N000) for installing on the rear slot of the chassis.

1.3.5 Graphics

- **Graphics Processor:** Integrated Intel® HD Graphics
- **Display Memory:** 1 GB max. shared memory with 2 GB min. system memory (BIOS default is 256 MB)
- **DVI-D:** Two DVI-D ports with up to 1920x1200 resolution @ 60 Hz refresh rate
- **D-Sub:** Up to 1920x1200 resolution @ 60 Hz refresh rate
- **HDMI:** Supports HDMI 2.0 with up to 4096x2160 resolution @ 60 Hz refresh rate

1.3.6 Ethernet LAN

- **Interface:** Supports four 10/100/1000 Mbps Ethernet port (s) via PCIe bus which provides a 500 MB/s data transmission rate.
- **Controller:** LAN1: Intel® I219-LM; LAN2 ~ 4: Intel® I210-AT (LAN2 is BMC shared NIC and LAN3/4 is for G4 SKU).

1.3.7 Industrial Features

- **Watchdog Timer:** The watchdog timer is programmable, with each unit equal to one second or minute (255 intervals), and can be used to generate a system reset or NC.
- **IPMI:** AST2400 BMC onboard support enables IPMI 2.0 features (G4 SKU only).

1.3.8 Mechanical and Environmental Specifications

- **Operating Temperature:** 0 ~ 60 °C (32 ~ 140 °F) depending on CPU
- **Storage Temperature:** -40 ~ 85 °C (-40 ~ 185 °F)
- **Humidity:** 5 ~ 95% non-condensing
- **Power Supply:** +3.3 V, +5 V, ±12 V, 5 VSB
- **Power Consumption:**
Max. load: +3.3 V @ 3.44 A, +5 V @ 2.61 A, +12 V @ 1.04 A, +12 V (8P) @ 6.3 A, +5 VSB @ 0.09 A, -12 V @ -0.02 A
- **Board Dimensions:** 304.8 x 244 mm (12 x 9.6 in)
- **Board Weight:** 0.75 kg (1.65 lb)

1.4 Jumpers and Connectors

The ASMB-786 motherboard features connectors for integrating external devices, such as a hard disk drive or keyboard. Moreover, the board also has a number of jumpers that can be used to configure the system for specific applications.

The function of each jumper and connector is listed in the tables below. Instructions for setting jumpers are provided in subsequent sections. For information regarding connecting external devices to the motherboard, refer to Chapter 2.

Table 1.1: Jumper List

Label	Function
CPUFAN_SEL1, SYSFAN_SEL1	FAN PWM (1-2)/DC mode (2-3)
HDMI_I2C1	For RD debugging purposes
JCASE1	Case open
JCMOS1	CMOS clear
JME1	Intel ME disable jumper for ME/BIOS update
JPEG1, JPEG2	PCIEX16_Slot6 PCIe link switch between one x16 or two x8, or x8 plus two x4
JPRSEN1	PCIe card present pin support
JSMB1	For RD debug purpose
JTHR_SEL1	To select on board or external thermometer
JUSB1	Rear window USB 2.0/3.0 port power source switch between +5 VSB and +5 V
JUSB2	On board USB 2.0/3.0 port power source switch between +5 VSB and +5 V
JWDT1	Watch dog reset
PSON1	AT(1-2) / ATX(2-3)

Table 1.2: Connector List

Label	Function
ATXPWR1	ATX 24-pin main power connector (for system)
ATX12V1	8-pin power connector (for CPU)
AUDIO1	Audio connector
BAT2	For optional battery kit
BMC_SPI1	BMC image ROM
BMC_VGA1	BMC VGA connector (G4 SKU)
COM1*, COM2	Serial port: RS-232
CPUFAN0	CPU FAN connector
DIMMA0,DIMMA1, DIMMB0,DIMMB1	DDR4 288-pin slot
DVI1	DVI-D connector
EX_THR1	For external thermistor cable kit
FPAUD1	Audio front panel header
GPIO1	8-bit GPIO header
HDMI1_VGA1	HDMI + VGA connector
JFP1	Power switch/reset connector
JFP2	External speaker/HDD LED connector/SMBus connector
JFP3	Keyboard lock and power LED

Table 1.2: Connector List

KBMS1	External keyboard and mouse connector (6-pin)
LAN1_USB1_2, LAN2_USB3_4	LAN1/USB 3.1 port 1, 2 stack connector LAN2/USB 3.1 port 3, 4 stack connector
LAN3_4	LAN3 & LAN4 connector (G4 SKU)
LANLED1	LAN LED extension connector
LPC1	Low pin count connector for Advantech TPM LPC and RS-232/422/485 modules
LPT1	Parallel port
PCIX1_SLOT1, PCIX1_SLOT3, PCIX1_SLOT5	PCIe x1 slot (Gen3 x1 link)
PCIEX4_SLOT2, PCIEX4_SLOT7	PCIe x4 slot (Gen3 x4 link)
PCIEX16_SLOT4, PCIEX16_SLOT6	PCIe x16 slots (one Gen3 x16 link for slot 6 or two Gen3 x8 link)
PMBUS1	PMBUS connector to communicate with power supply
SATA0~7	SATA III (6 Gb/s)
SGPIO1, SGPIO2	Serial general purpose I/O
SMBUS1	SM Bus From PCH
SPDIF_OUT1	SPDIF audio output pin header
SPI1	BIOS SPI ROM
SPI_CN1	SPI flash card pin header (for RMA)
SYSFAN0, SYSFAN1, SYSFAN2, SYSFAN3	System fan connector
SYS_LED1	System information LED connector (reserved)
USB7_8, USB9_10, USB11_12	USB 2.0 port (header)
USB13	USB 2.0 port (USB Type A)
USB5_6	USB 3.1 Gen1 port (header)
VOLT1	Voltage display

Note: COM1 in BIOS is directed to the PCB silkscreen as COM1 or COM3.

1.5 Jumper and Connector Locations

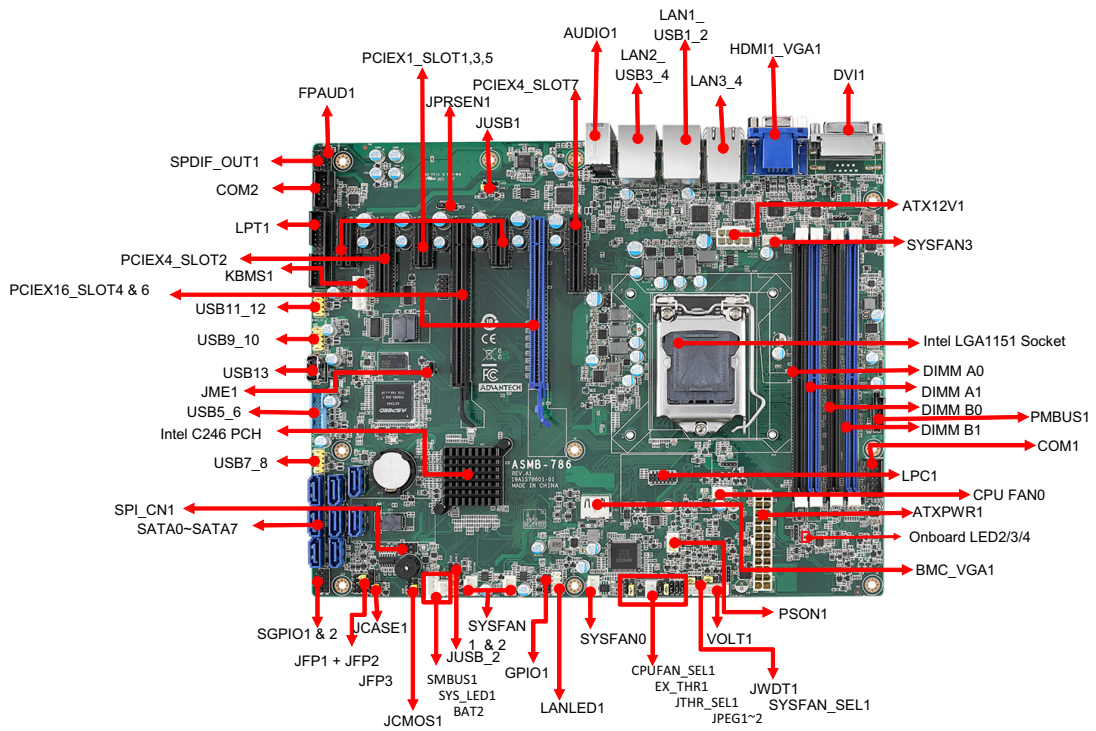

Figure 1.1 Jumper and Connector Locations

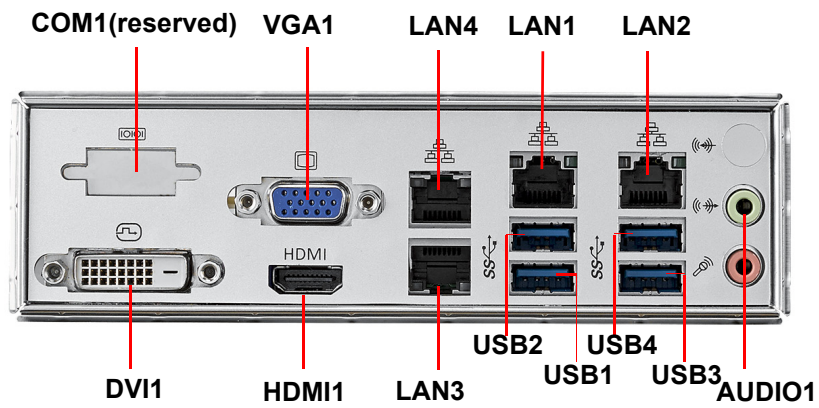
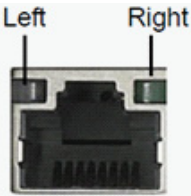

Figure 1.2 I/O Connectors (G4 SKU)

1.5.1 Onboard LAN LED Definition

Table 1.3: Onboard LAN LED Definition

10/100/1000 Mbps LAN Link/Activity LED Scheme					
		LAN1 ~ LAN2		LAN3 ~ LAN4	
		Left LED	Right LED	Left LED	Right LED
10 Mbps	Link Active	Off Off	Green Blinking green	Green Blinking green	Off Off
100 Mbps	Link Active	Amber Amber	Green Blinking green	Green Blinking green	Amber Amber
1000 Mbps	Link Active	Green Green	Green Blinking green	Green Blinking green	Green Green
No Link		Off	Off	Off	Off

1.5.2 Onboard LEDs (LED2, LED3, and LED4)

ASMB-786 features an onboard power LED indicator for 5 V Power, 5V Standby, and 3.3V AUX modes.

Table 1.4: Onboard LEDs (LED2, LED3, and LED4)

LED	Description	LED Definition	
5V_LED2	Power on LED	Off: Power off	On (Green): System is on
5VSB_LED3	Standby LED	Off: No input AC power	On (Green): System is on, in sleep mode, or in soft-off mode
3V3DSW_LED4	Deep sleep LED	Off: No input AC power, deep sleep mode enable	On (Green): System is on, in sleep mode, in soft-off mode, or deep sleep mode disable

1.6 ASMB-786 Block Diagram

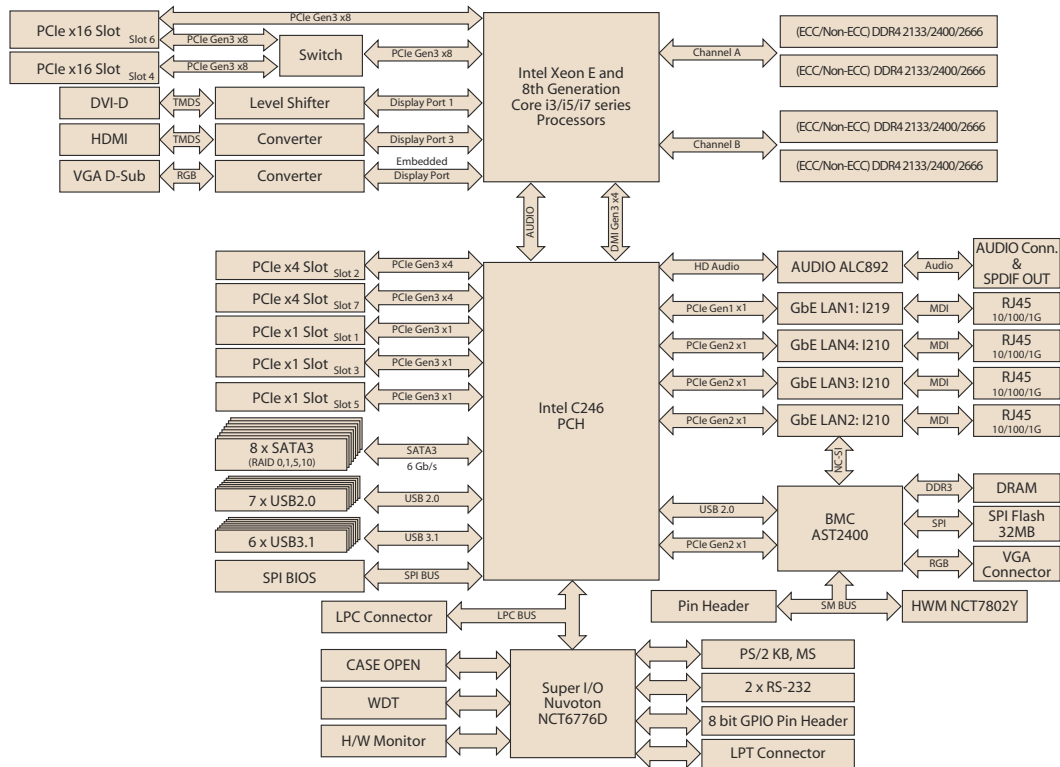

Figure 1.3 ASMB-786 Block Diagram

1.7 Safety Precautions

Warning! *Always completely disconnect the power cord from the chassis before manually handling the hardware. Do not make connections while the power is on. Sensitive electronic components can be damaged by sudden power surges. Only experienced electronics personnel should open the PC chassis.*



Caution! *Always ground yourself to remove any static charge before touching the motherboard. Modern electronic devices are very sensitive to static electric discharges. As a safety precaution, use a grounding wrist strap at all times. Place all electronic components on a static-dissipative surface or in a static-shielded bag when they are not in the chassis.*



Caution! *The computer is provided with a battery-powered real-time clock circuit. Batteries are at risk of exploding if incorrectly replaced. Replace only with same or equivalent type as recommended by the manufacturer. Discard used batteries according to the manufacturer's instructions.*



Caution! *There is a danger of a new battery exploding if incorrectly installed. Do not attempt to recharge, force open, or heat the battery.*



1.8 Jumper Settings

This section provides instructions on how to configure the motherboard by setting the jumpers. An explanation of the motherboard default settings and options for each jumper is also provided.

1.8.1 How to Set Jumpers

Users can configure the motherboard according to specific application needs by setting the jumpers. A jumper is a metal bridge that closes an electrical circuit. It consists of two metal pins and a small metal clip (often protected by a plastic cover) that slides over the pins to connect them. To “close” (or turn on) a jumper, connect the pins with the clip. To “open” (or turn off) a jumper, remove the clip. Some jumpers consist of a set of three pins labeled 1, 2, and 3. With these jumpers, either connect pins 1 and 2, or 2 and 3. A pair of needle-nose pliers may be useful when setting jumpers.

1.8.1.1 CMOS Clear (JCMOS1)

The ASMB-786 motherboard is equipped with a jumper that can erase CMOS data and reset the system BIOS information. This jumper is set with pins 1-2 closed as a default. To reset the CMOS data, set JCMOS1 to 2-3 closed for just a few seconds, and then move the jumper back to 1-2 closed. This will reset the CMOS to its default setting.

Table 1.5: CMOS Clear (JCMOS1)

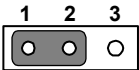
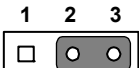
Function	Jumper Setting
Keep CMOS data*	 1-2 closed
Clear CMOS data	 2-3 closed
*Default setting	

1.8.1.2 ME Update (JME1)

ASMB-786 is equipped with a jumper that can update ME firmware. This jumper is set with pin 1-2 closed as a default. To update the ME firmware, set JME1 to 2-3 closed to disable ME for new ME firmware updates.

Table 1.6: ME Update (JME1)

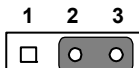
Function	Jumper Setting
Lock ME update*	1-2 closed
ME update	 2-3 closed
*Default setting	

1.8.1.3 Watchdog Timer Output (JWDT1)

ASMB-786 is equipped with a watchdog timer that will reset the CPU. This feature means that the ASMB-786 motherboard can recover from a software failure or EMI problem. The JWDT1 jumper settings control the actions taken in the event that the watchdog timer is tripped.

Table 1.7: Watchdog Timer Output (JWDT1)

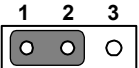
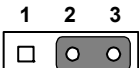
Function	Jumper Setting
Reset*	 1-2 closed
NC	 2-3 closed
*Default setting	

Note! The interrupt output of the watchdog timer is a low-level signal that remains low until the watchdog timer is reset.



1.8.1.4 USB Power Switch (JUSB1/JUSB2)

ASMB-786 is equipped with a jumper that supports a +5 VSB or +5 V power source for onboard USB ports. The JUSB1 jumper controls the USB 3.1 Gen2 ports of the rear window. The JUSB2 jumper controls the USB 2.0 and USB 3.1 Gen1 ports of the onboard header and connectors. The default setting is 1-2 closed, which supports USB standby power under S5. When the jumper is 2-3 closed, the onboard USB port power source will switch to +5 V to disable USB standby power under S5, and under 2-3 closed, which does not support S3 and S4 modes.

Table 1.8: USB Power Switch (JUSB1/JUSB2)

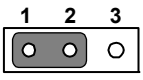
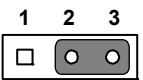
Function	Jumper Setting
+5 VSB*	 1-2 closed
+5 V	 2-3 closed
*Default setting	

1.8.1.5 CPU and System Fan PWM/DC Mode Selection

ASMB-786 is equipped with a jumper that can support PWM or DC modes. This jumper is set with pin 1-2 closed as the default. To change to DC mode, set CPUFAN_SEL1, SYSFAN_SEL1 to 2-3 closed for disable.

Table 1.9: Fan Mode Selection (CPUFAN_SEL1, SYSFAN_SEL1)

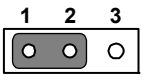
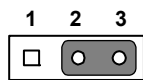
Function	Jumper Setting
PWM mode*	 1-2 closed
DC mode	 2-3 closed
*Default setting	

1.8.1.6 ATX/AT Mode Selector (PSON1)

ASMB-786 is equipped with a jumper that can support ATX or AT modes. This jumper is set with pin 2-3 closed as the default. To change to AT mode, set PSON to 1-2 closed.

Table 1.10: ATX/AT Mode Selector (PSON1)

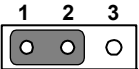
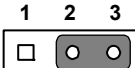
Function	Jumper Setting
AT Mode	 1-2 closed
* ATX Mode	 2-3 closed
* default setting	

1.8.1.7 PCIe Link Switch (JPEG1, JPEG2)

ASMB-786 is equipped with a jumper that can switch one PCIe x16 link on PCIEx16_Slot6 to two x8 links on PCIEx16_Slot6 and Slot4. The default setting with pin 1-2 closed is one x16 on PCIEx16_Slot6 (PCIEx16_Slot4 is disabled). To use PCIEx16_Slot4 with a x8 link, set JPEG1 to 2-3 closed and keep JPEG2 pin 1-2 closed to enable this function. For details regarding the jumper settings to support a riser card, refer to Section 2.14 “PCIe x16 Expansion Slot” in the next chapter.

Table 1.11: PCIe Link Switch (JPEG1, JPEG2)

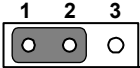
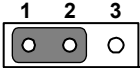
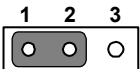
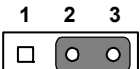
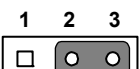
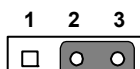
Function	JPEG1	JPEG2
Slot6 PCIe x16*	 1-2 closed	 1-2 closed
Slot6 PCIe x8/x8	 1-2 closed	 2-3 closed
Slot6 PCIe x8/x4/x4	 2-3 closed	 2-3 closed
*Default setting		

1.9 System Memory

The ASMB-786 motherboard features four 288-pin memory sockets for DDR4 unbuffered ECC/non-ECC 2666/2400/2133 MHz memory modules and supports a maximum capacity of 64 GB (16 GB for each DIMM).

Note! ASMB-786 does NOT support registered DIMMs (RDIMMs).



Chapter 2

Connecting
Peripherals

2.1 Introduction

Most connectors can be accessed from the top of the motherboard during installation in the chassis. If multiple cards are installed, users may need to partially remove one card in order to implement all the connections.

2.2 USB Ports (LAN1_USB1_2, LAN2_USB3_4, USB5~13)

ASMB-786 provides up to 13 USB ports. USB7~13 are USB 2.0 ports that support data transmission rates of up to 480 Mbps, USB1~4 are USB 3.1 Gen2 ports with transmission rates of up to 10 Gbps, and USB5~6 are USB 3.1 Gen1 ports with transmission rates of up to 5 Gbps. These ports support plug-and-play functionality and hot swapping for up to 127 external devices, which can be disabled in the BIOS menu.

The ASMB-786 motherboard is equipped with two (G2 SKU) or four (G4 SKU) high-performance 1000 Mbps Ethernet LANs supported by all major network operating systems. The RJ-45 jacks on the rear plate provide convenient 1000 Mbps operation. If all USB ports are used, we recommend switching the USB power to +5 V instead of +5 VSB.

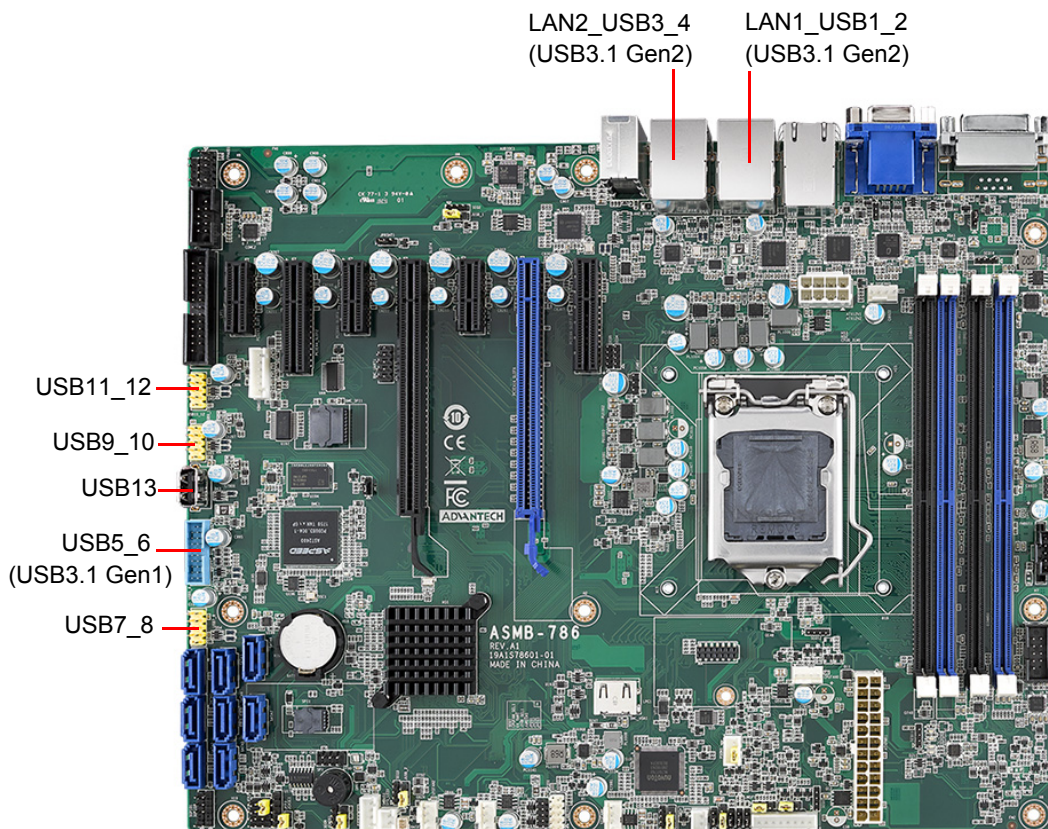

2.3 USB Power Switch (JUSB1, JUSB2)

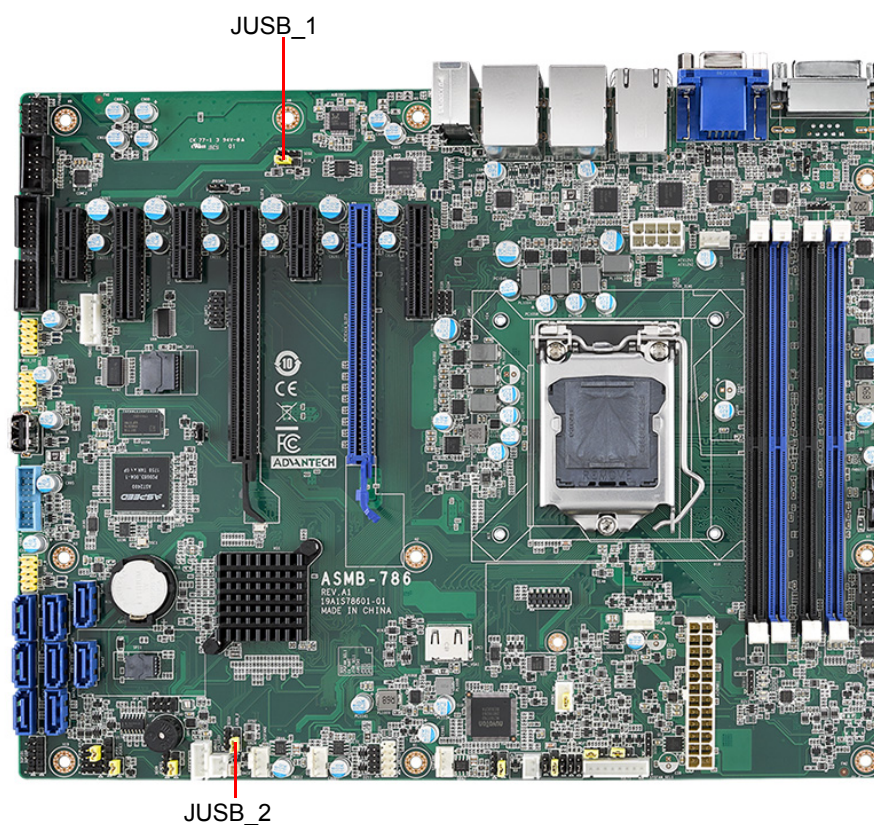

ASMB-786 allows users to switch the USB power between +5 VSB and +5 V. When the jumper is set as +5 V, the board does not support S3/S4. Refer to Section 1.8.1.4 “USB Power Switch” for information regarding the jumper settings.

Jumper	USB Ports
JUSB1	Rear window USB 3.1 Gen2 port power source switch between +5 VSB and +5 V
JUSB2	Onboard USB 2.0/3.1 Gen1 port power source switch between +5 VSB and +5 V

Note! When the USB power is switched to +5 V, a powered KVM cannot be connected to the port.



2.4 Display Connector (HDMI1_VGA1, DVI1)

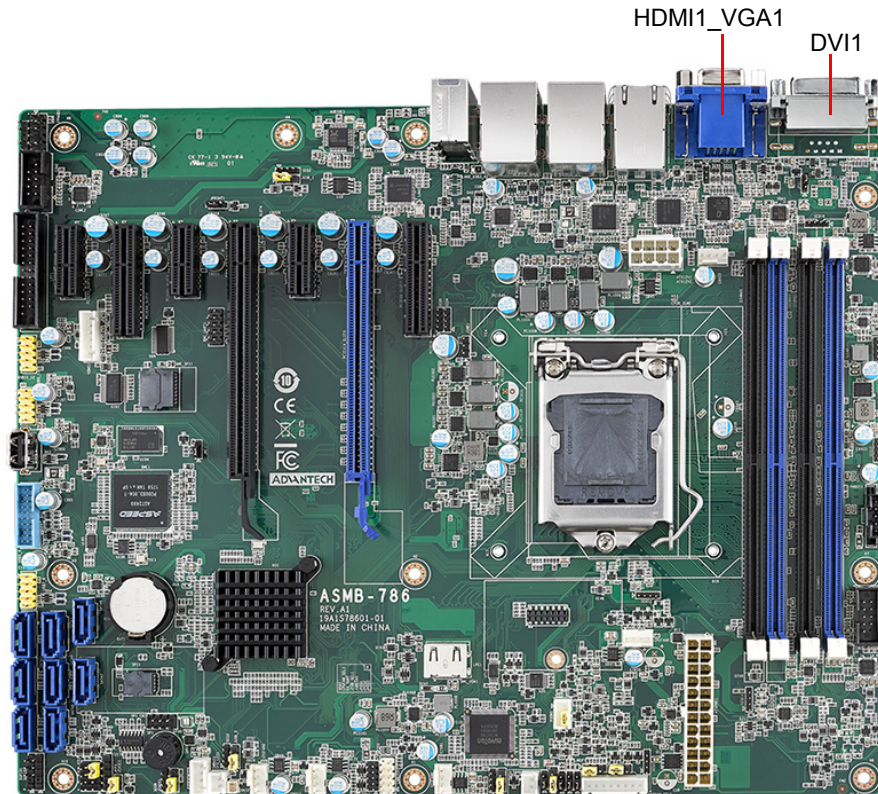

The ASMB-786 motherboard is equipped with VGA, DVI-D, and HDMI connectors to support triple display outputs. All display output ports can function simultaneously, however, the resulting performance may differ according to the OS. Additionally, one BMC VGA onboard connector (HDMI type) can support remote KVM displays with the inclusion of an optional VGA cable (P/N: 1700029038-01, for G4 SKU only). To enable this function, ensure that the BMC VGA driver is installed before connecting the VGA cable.

2.5 Serial Ports (COM1 ~ COM2)

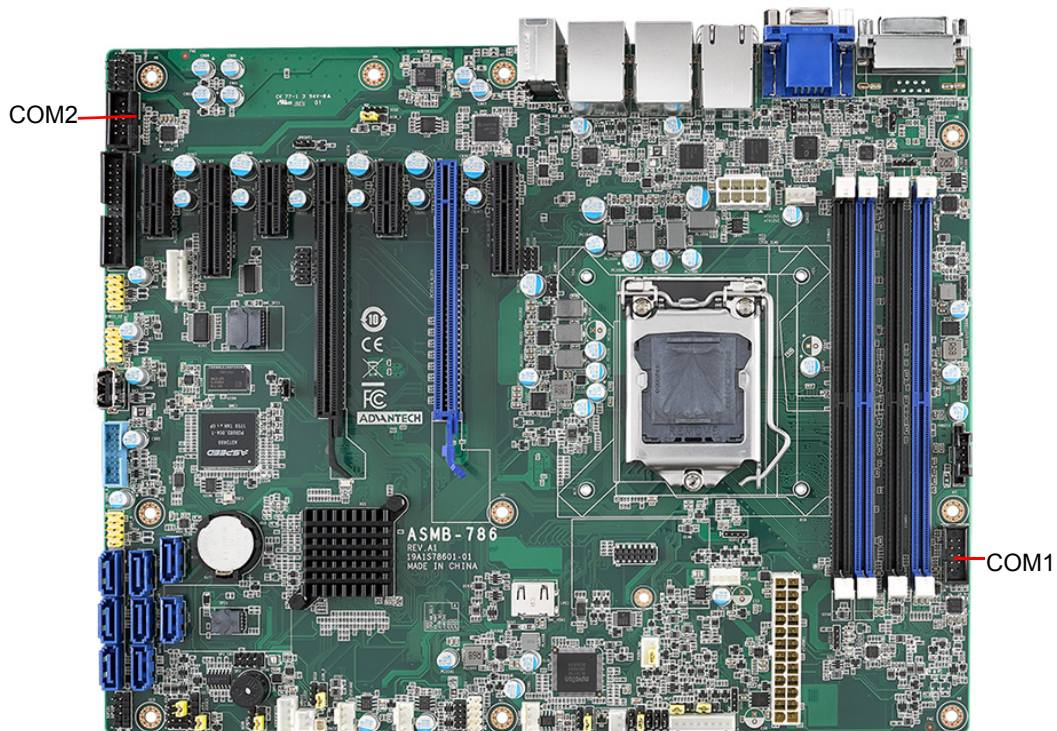

ASMB-786 features two serial ports onboard (one can be connected to the rear panel using the dedicated COM cable kit provided in the accessory box) for connecting a serial mouse, printer, or communications network. The IRQ and address ranges for these ports are fixed. However, users can disable the ports or change their parameters via the system BIOS. Different devices implement the RS-232 standards in different ways.

Up to eight COM ports may appear in Windows Device Managers when all devices are enabled. COM1 and COM2 are reserved for RS-232, COM3 is reserved as a virtual COM port for Linux OS, and COM4 is reserved for Intel AMT/IPMI SOL support. COM5~COM8 provide additional serial ports when the Advantech optional COM module is installed on LPC1.

2.6 External Keyboard and Mouse (KBMS1)

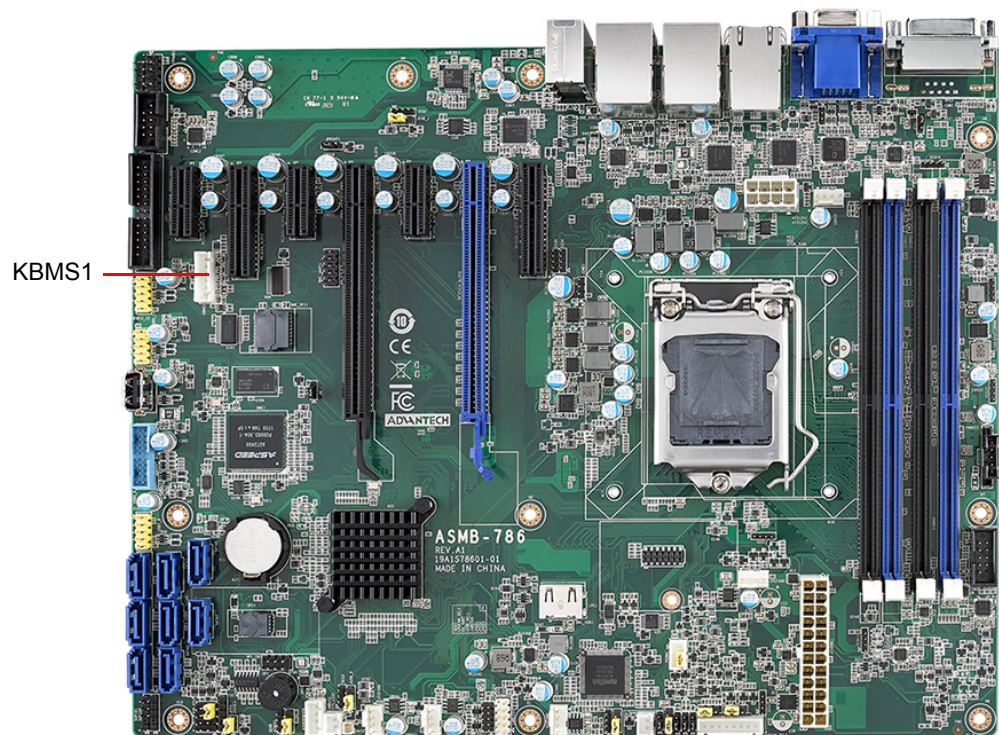

The ASMB-786 motherboard is equipped with an onboard external keyboard and mouse connector, which offers system integrators greater flexibility when designing systems.

Cables for the onboard KBMS connector and cable bracket installed at the rear of the system are available upon request (P/N: 1700019268-11, 1960063434N000).

2.7 CPU Fan Connector (CPUFAN0)

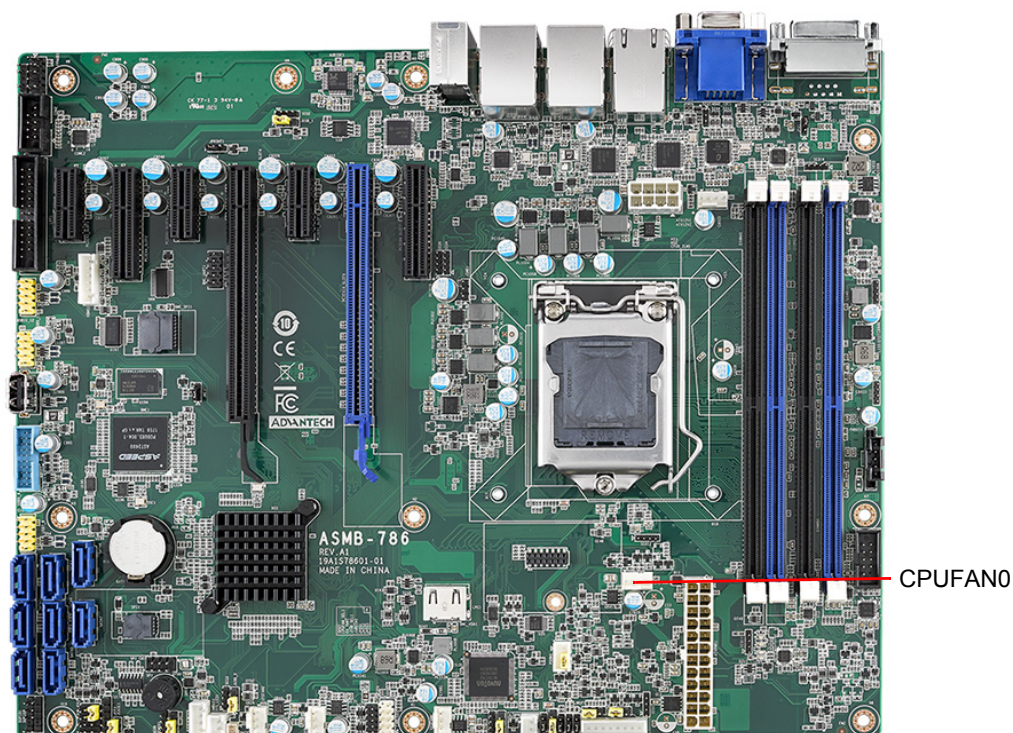

If a CPU fan is installed, this connector supports cooling fans that draw up to 2.5 A (30 W).

2.8 System FAN Connector (SYSFAN0 ~ SYSFAN3)

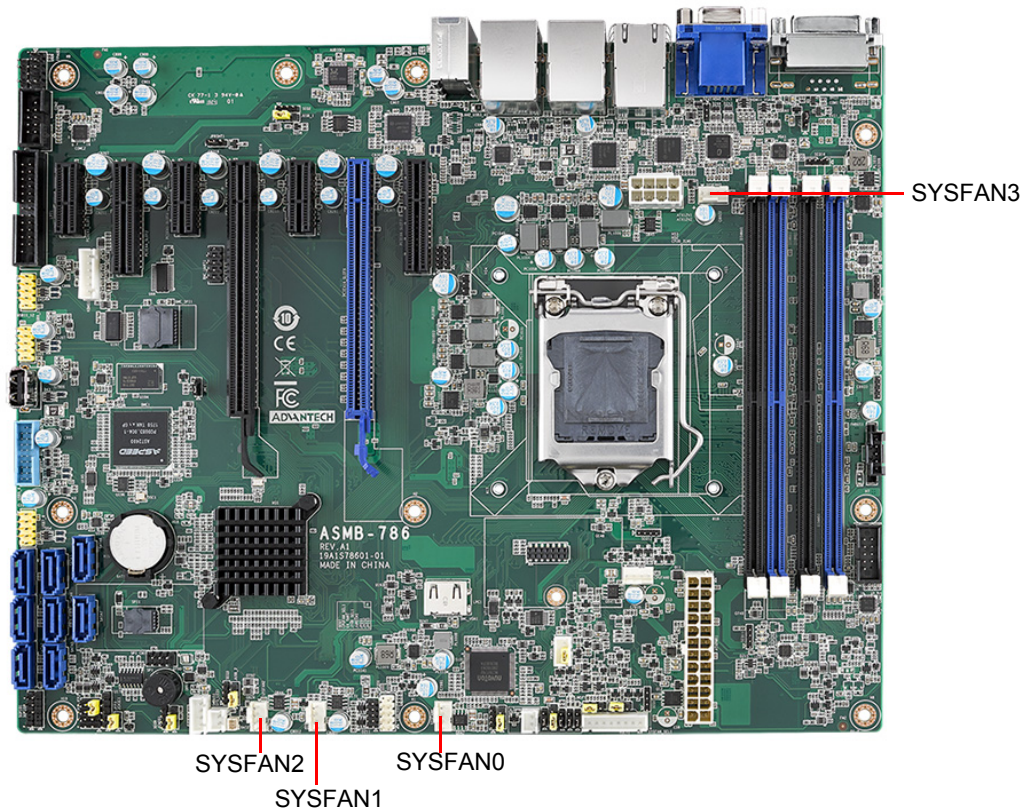

If a system fan is installed, this connector supports cooling fans that draw up to 2.5 A (30 W).

2.9 Front Panel Connectors (JFP1, 2, 3)

Several external switches and LED indicators are provided for monitoring and controlling the ASMB-786 functions.

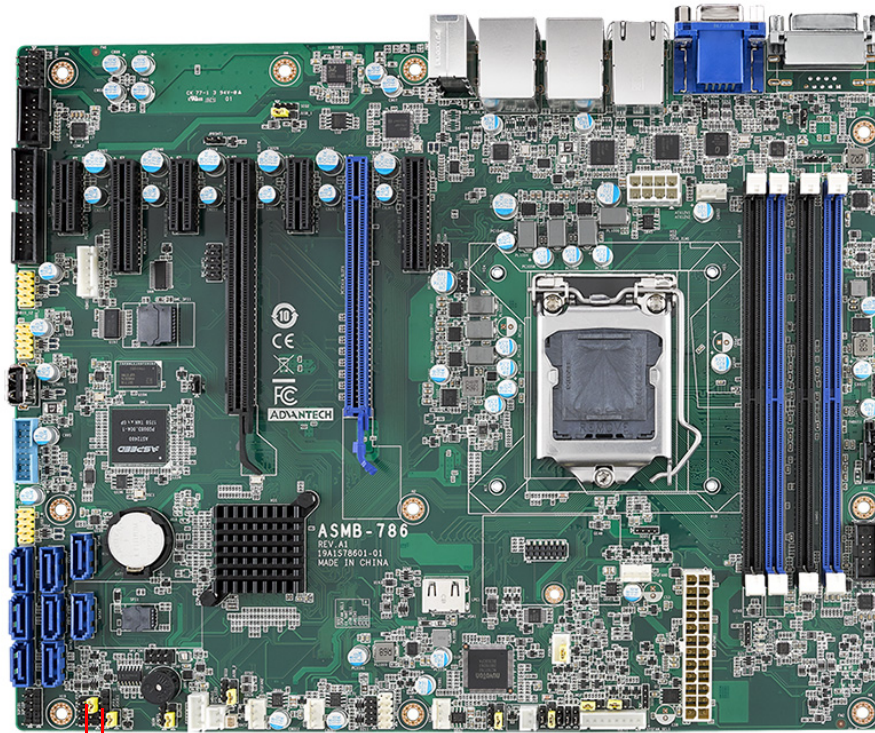

JFP1 + JFP2
JFP3

JFP1	3	6	9	12	PWRSW	RESET
&	2(+)	5(-)	8	11		
JFP2	1	4	7	10	SPEAKER	
JFP3	1	2	3	4	PWRLED & KEYLOCK	
	(+)	(-)				

2.9.1 Power LED (JFP3 Pins 1, 3)

JFP3 is a 5-pin connector for the power LED indicator. Refer to Appendix B for detailed information regarding the pin assignments. If an ATX power supply is used, the system's power LED status will be as indicated as follows.

Power Mode	LED Status
System On	On
System Suspend	Fast flashing (S1, S3)/slow flashing (S4)
System Off	Off
System Off in Deep Sleep	Off

2.9.2 External Speaker (JFP2 Pins 1, 4, 7, 10)

The JFP2 connector pins 1, 4, 7, and 10 are for integrating an external speaker. ASMB-786 provides an onboard buzzer as an alternative. To enable the onboard buzzer, set pins 7-10 as closed.

2.9.3 HDD LED Connector (JFP1 Pins 2, 5)

Users can connect an LED indicator to a JFP1 connector to show the HDD status.

2.9.4 SNMP SMBus Connector (JFP2 Pins 8, 11)

ASMB-786 supports Advantech's Intelligent System Module for providing platform-independent system management. To install a module on the ASMB-786 motherboard, connect the module to pins 8 and 11 of JFP2 (pin 8 is the data pin and pin 11 is the clock pin).

2.9.5 ATX Soft Power Switch (JFP1 Pins 3, 6)

If the computer case is equipped with an ATX power supply, users can connect the power on/off button on the computer case to pins 3 and 6 of JFP1. This connection enables users to power the computer on and off.

2.9.6 Reset Connector (JFP1 Pins 9, 12)

Many computer cases offer the convenience of a reset button. To enable this function, connect the rest button on the computer case to pins 9 and 12 of JFP1.

2.10 Alarm Board Connector (VOLT1)

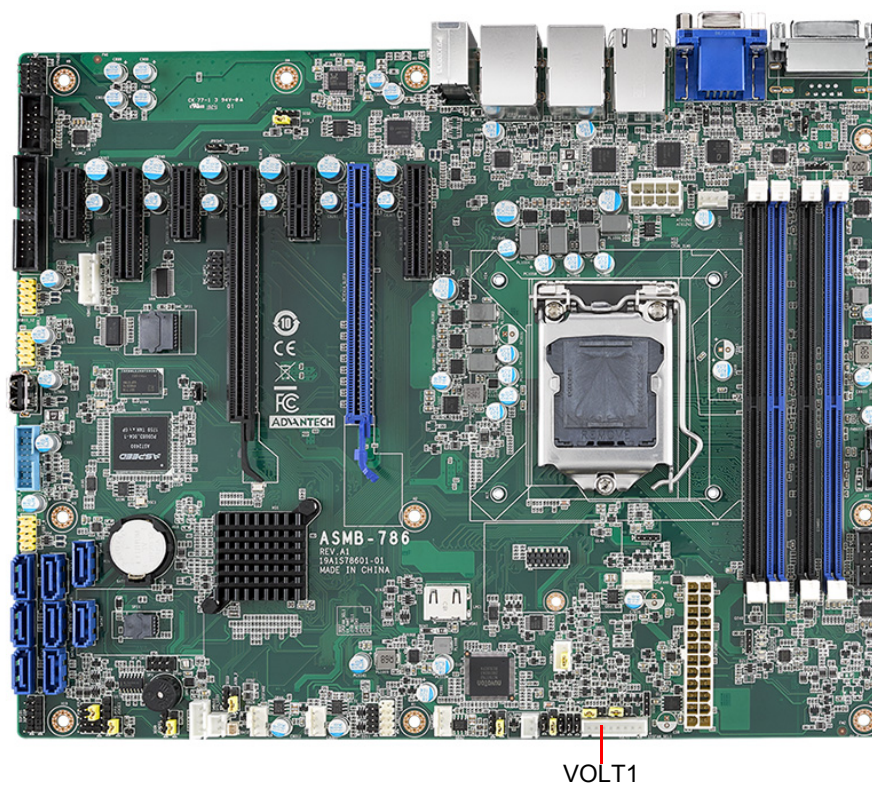

The 8-pin VOLT1 connector should be connected to the alarm board on the Advantech chassis. This alarm board monitors the input voltage at +12 V, +5 V, +5 VSB, -5 V, +3.3 V and -12 V, and issues warning alerts if the power supply fails.

2.11 Case Open Connector (JCASE1)

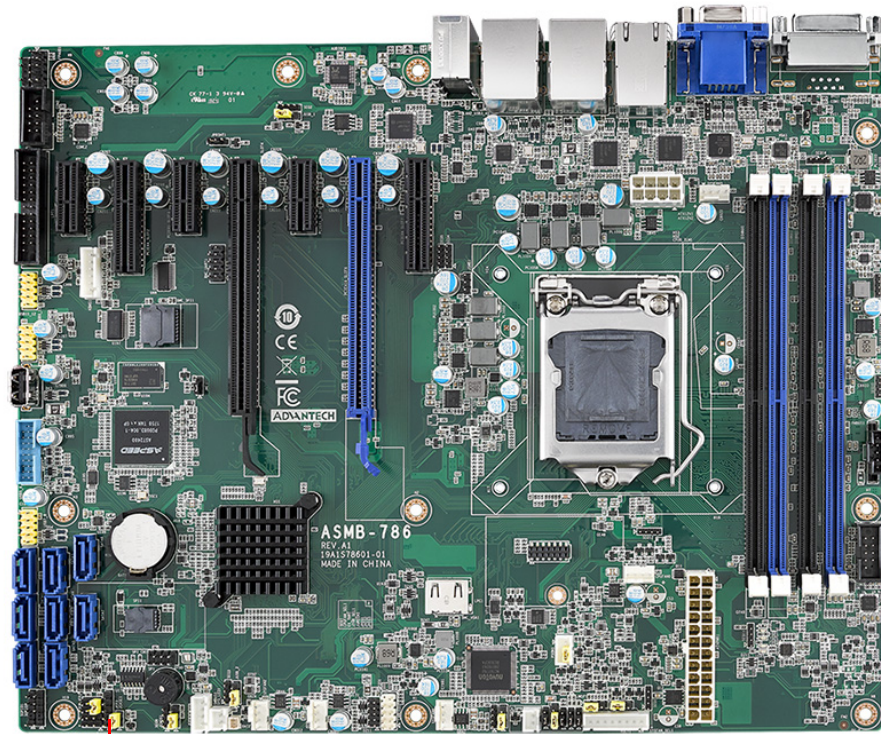

JCASE1

JCASE1 is for a chassis with a case open sensor. The default setting for JCASE1 is shorted by a jumper and disabled in the BIOS. To enable JCASE1, remove the jumper and connect JCASE1 to the chassis using an appropriate cable. Then change the BIOS settings to enable the case open function. If the chassis is opened, the BIOS will issue a warning message alerting of a chassis intrusion during system reboot and post screen.

2.12 Front Panel LAN Indicator Connector (LANLED1)

LANLED1 is an extended connector for LAN1~LAN4.

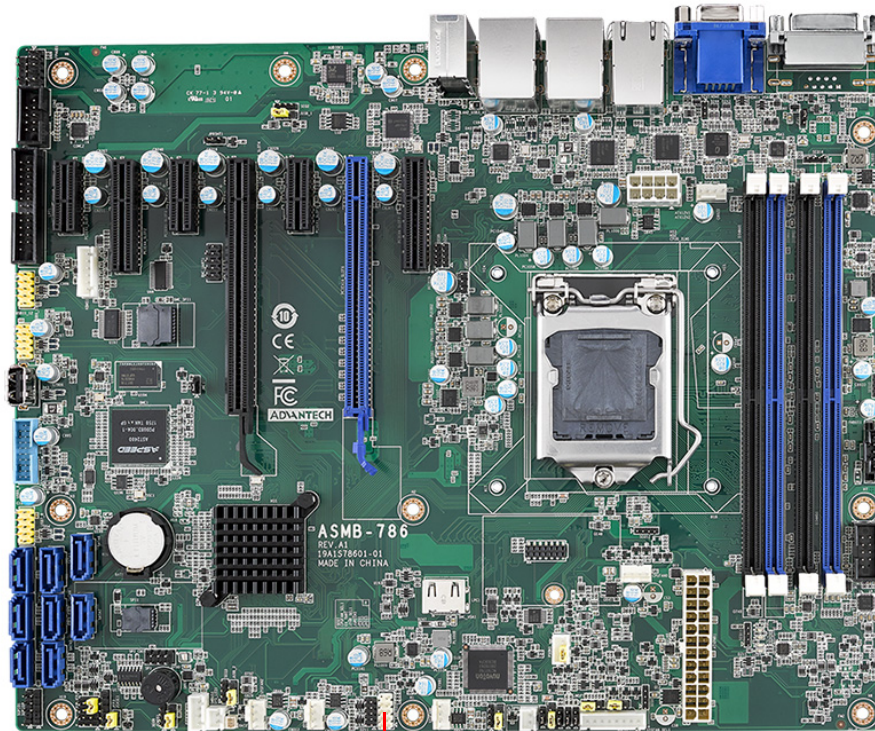

LAN_LED1

2.13 Serial ATA Interface (SATA0 ~ 7)

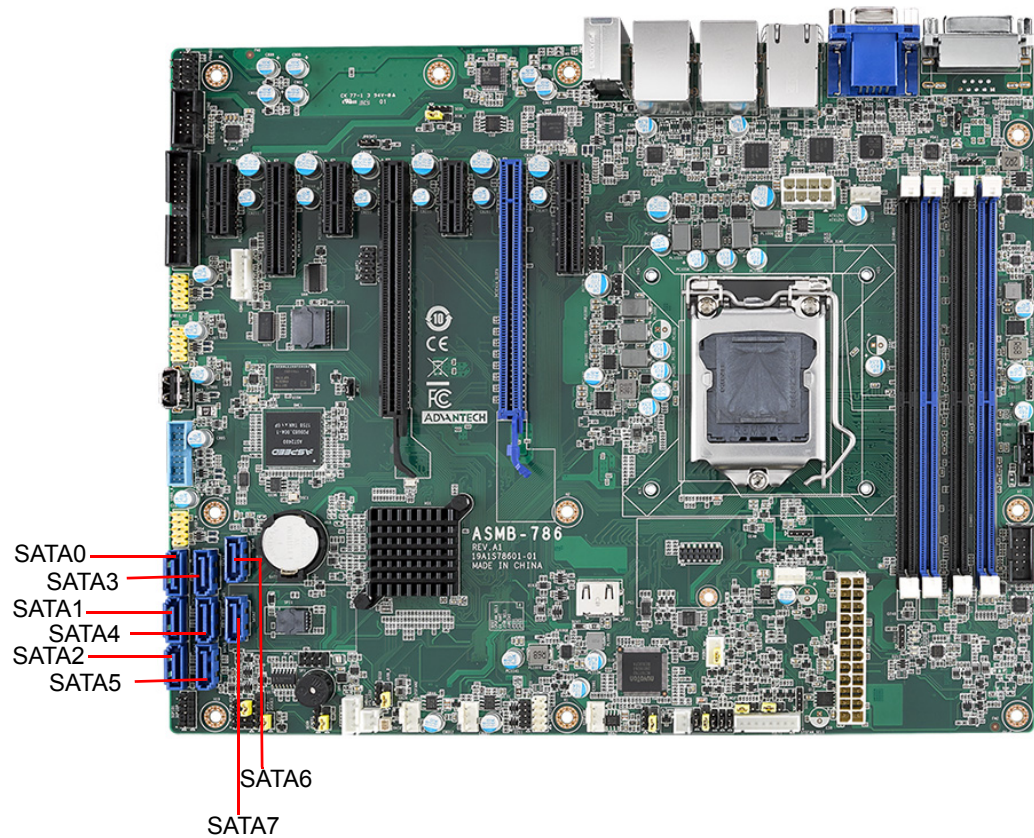

ASMB-786 features eight high-performance serial ATA III interfaces (up to 600 MB/s) for massive storage applications. Software RAID 0, 1, 10, and can be supported with Intel® Rapid Storage Technology enterprise.

2.14 PCIe x16 Expansion Slots

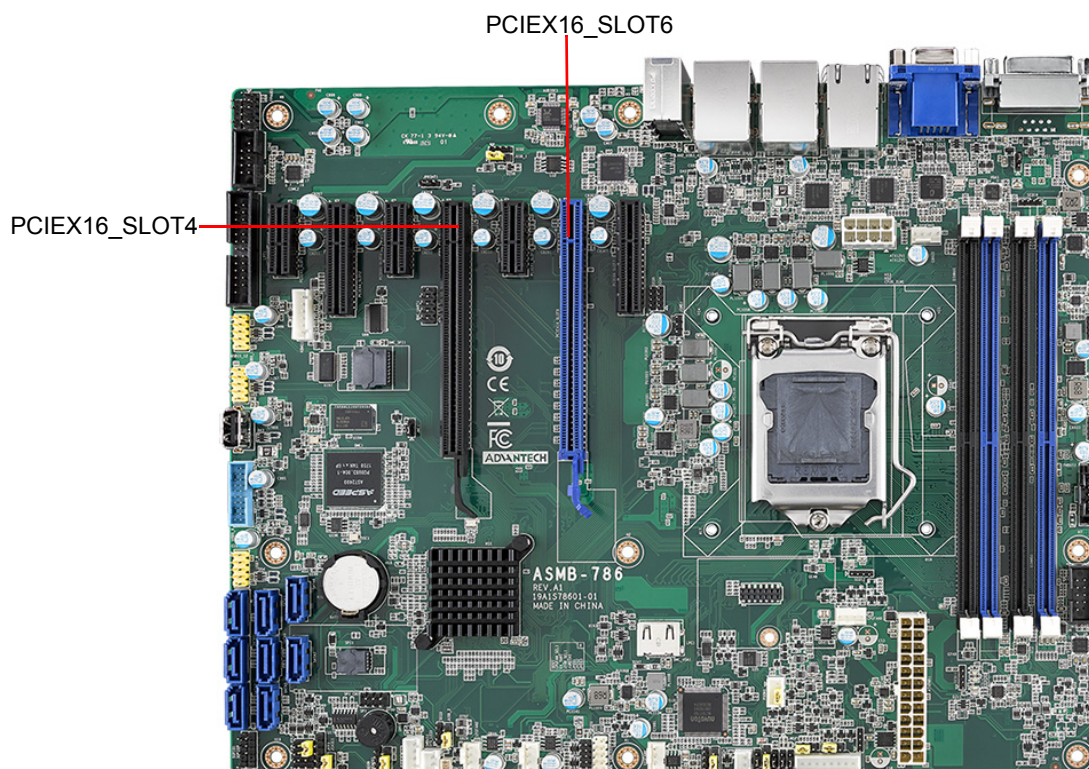

ASMB-786 provides one PCIe x16 slot (x16 link) or two PCIe x16 slots (x8 link) for users to install additional VGA cards for applications that require increased graphics performance than that offered by the CPU embedded graphics controller, or that require high-bandwidth I/O cards, such as a frame grabber card, RAID card, or 10G LAN card. The one x16 link on PCIEx16_Slot6 or two x8 links on PCIEs16_Slot6 and Slot4 can be set via JPEG1 and JPEG2.

Note! *If only one PCIe x16 card is installed, the card should be installed on PCIEx16_Slot6, and JPEG1 and JPEG2 set as one PCIe x16 link (both JPEG1 and JPEG2 are 1-2 closed).*



Some legacy cards may be incompatible with Windows 10 when the BIOS CSM configuration is set to Legacy mode. Contact your local field application engineers for technical support.

To change the JPEG1/JPEG2 jumper settings, support a Slot6 riser card is required.

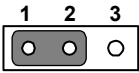
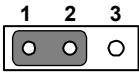
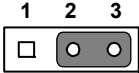
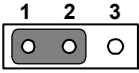
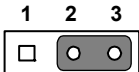
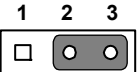
Function	JPEG1	JPEG2	Riser Card Support
PCIe x168	 1-2 closed	 1-2 closed	1U: AIMB-RF10F-01A1E 2U: ASMB-RF1F-10A1E AIMB-R43PF-21A1E
PCIe x8/x8	 2-3 closed	 1-2 closed	2U: ASMB-RF3X8-21A1E ASMB-RF348-21A1E ASMB-RF388-21A1E
PCIe x8/x4/x4	 2-3 closed	 2-3 closed	2U: ASMB-RF388-21A1E
*Default setting			

Note! *If an ASMB-RF348-21A1E riser card is installed and the PCIe x16 slot set to x8/x8 mode, the system can support one PCIe x4 (bottom slot) and one PCIe x8 (top slot). The middle PCIe x4 slot of the riser card is disabled by default.*



2.15 PCIe x4 Expansion Slots (PCIEx4_Slot2, 7)

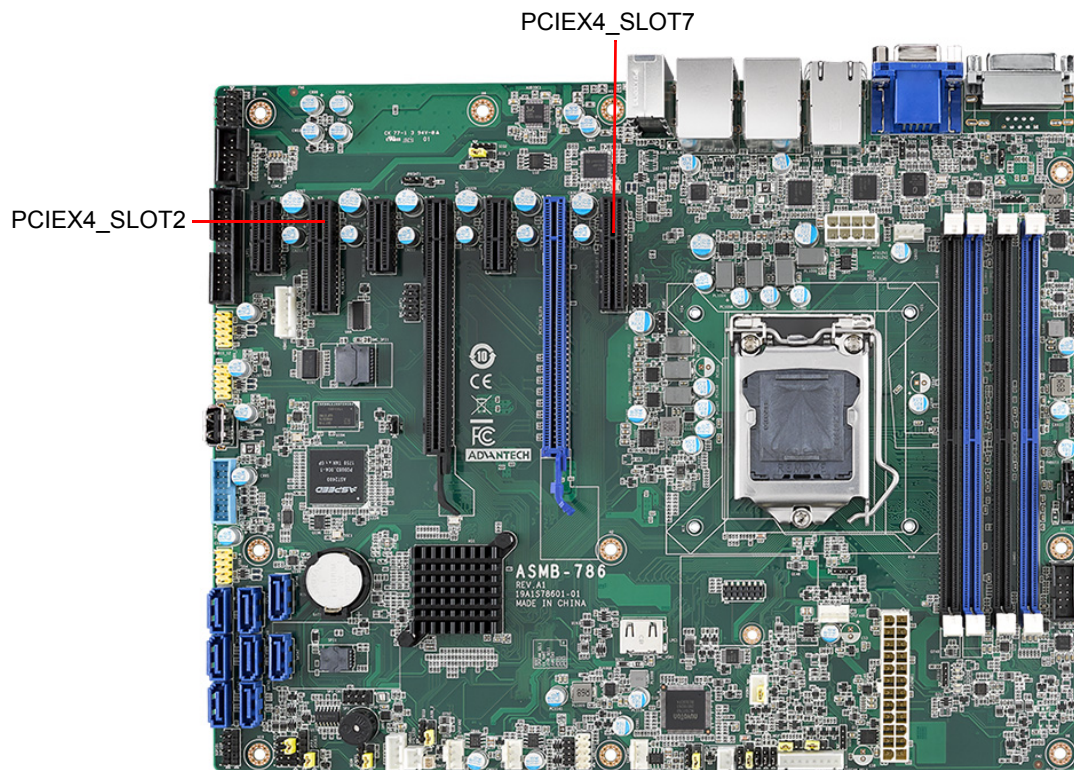

Both PCIEx4_Slot2 and PCIEx4_Slot7 feature Gen3 x4 link speed. Cards with higher speeds can be installed but will have to be downgraded for the x4 link.

2.16 PCIe x1 Expansion Slots (PCIEx1_Slot1, 3, 5)

PCIEX4_SLOT1 PCIEX4_SLOT3 PCIEX4_SLOT5

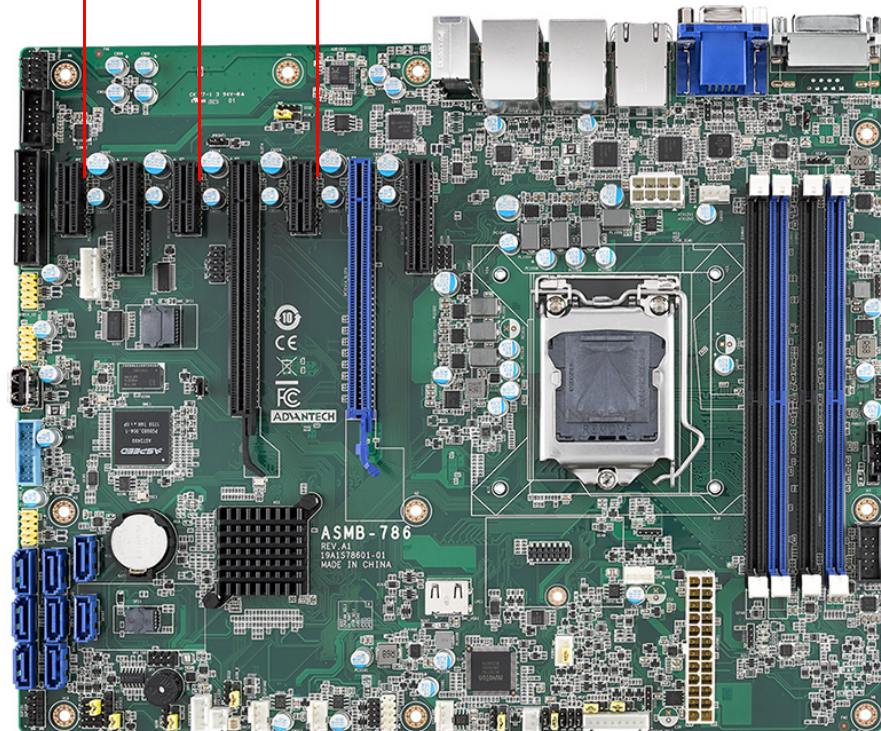

PCIEx4_Slot1, PCIEx4_Slot3, and PCIEx4_Slot5 feature Gen3 x1 link speed. Cards with higher speeds can be installed but will have to be downgraded for the x1 link.

2.17 Auxiliary Power Connector (ATX12V1)

This power connector is used to supply energy to the processor. We recommend using a power supply unit (PSU) that complies with ATX 12V Specification 2.0 (or a later version). Remember to connect the 8-pin power plug, or 4-pin-to-8-pin convertor cable (P/N:1700019748) if no 8-pin power plug is installed on the PSU, otherwise the system will not boot.

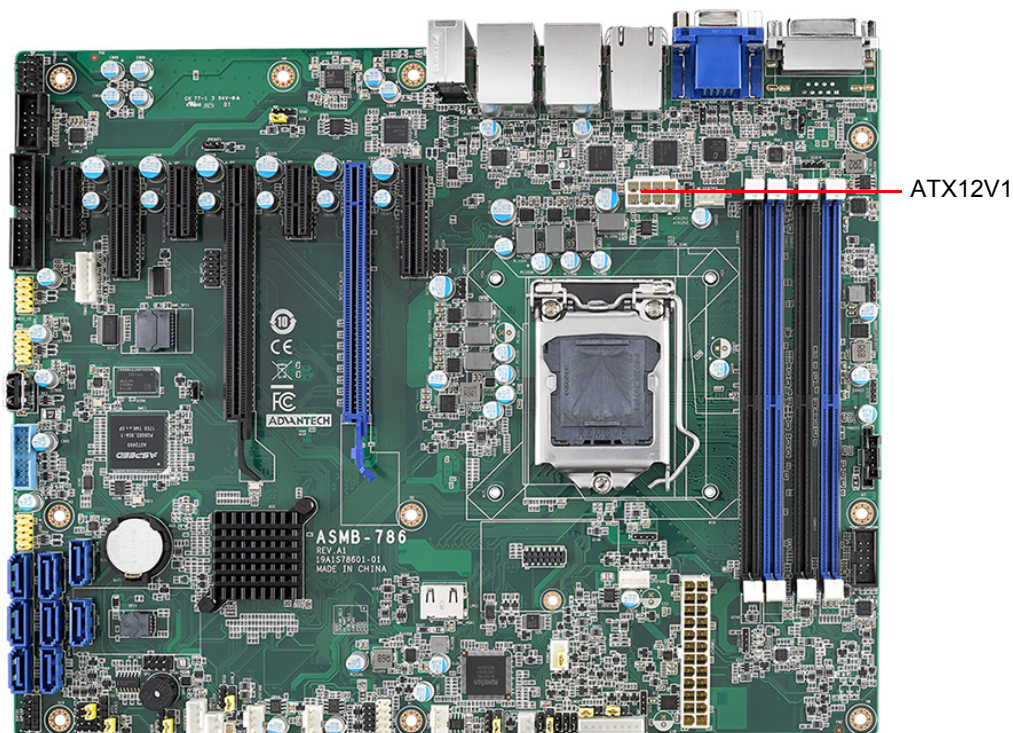

2.18 SPI Flash Connector (SPI_CN1)

The SPI flash programmer pin header (for RMA) can be connected to the BIOS-flashing tools for flashing the BIOS. Remember to power off the ASMB-786 motherboard before flashing the BIOS.

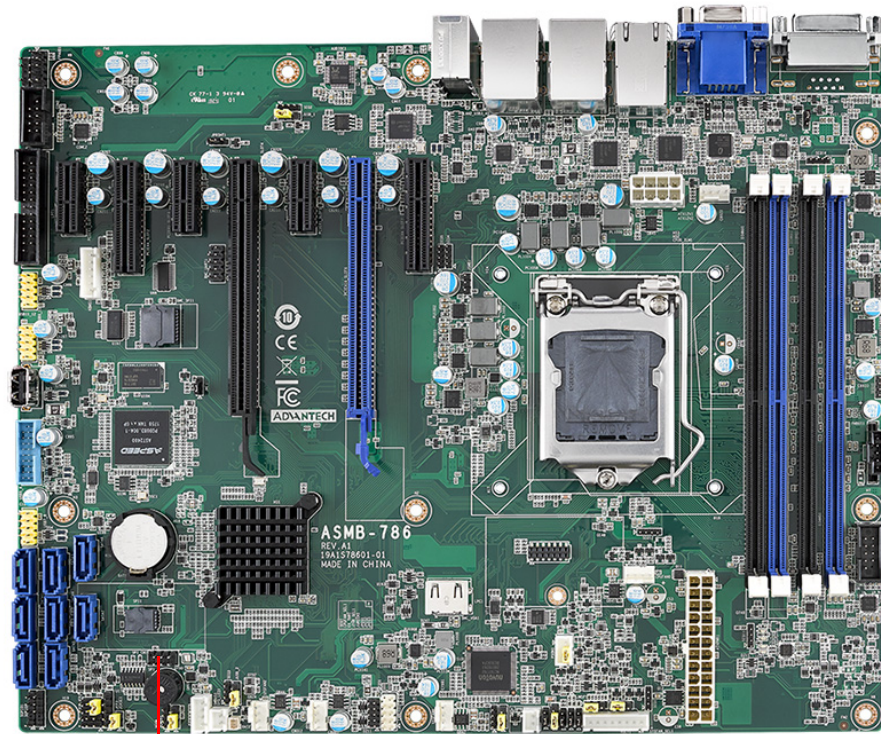

SPI_CN1

2.19 Low-Pin-Count Connector (LPC1)

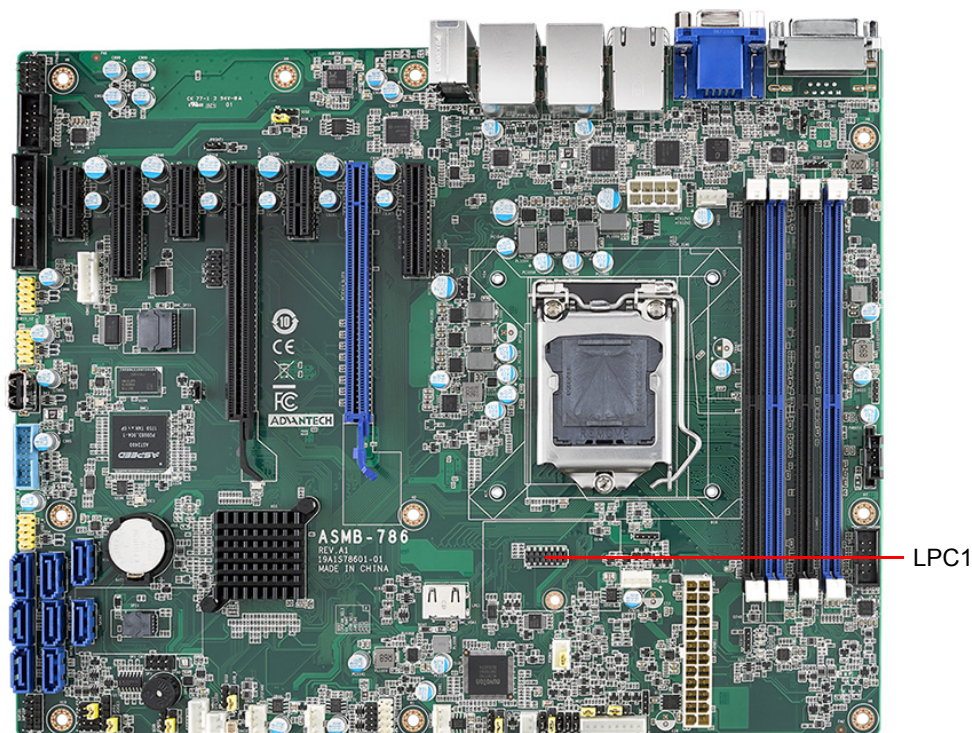

The LPC connector on the ASMB-786 motherboard is reserved for Advantech's TPM and COM RS-232/422/485 modules.

Part Number	LPC Module
PCA-TPM-00A1E	TPM 1.2 module
PCA-TPM-00B1E	TPM 2.0 module
PCA-COM232-00A1E	4-port RS-232 module connected to an LPC connector
PCA-COM485-00A1E	4-port RS-422/485 module connected to an LPC connector

2.20 Parallel Port (LPT1)

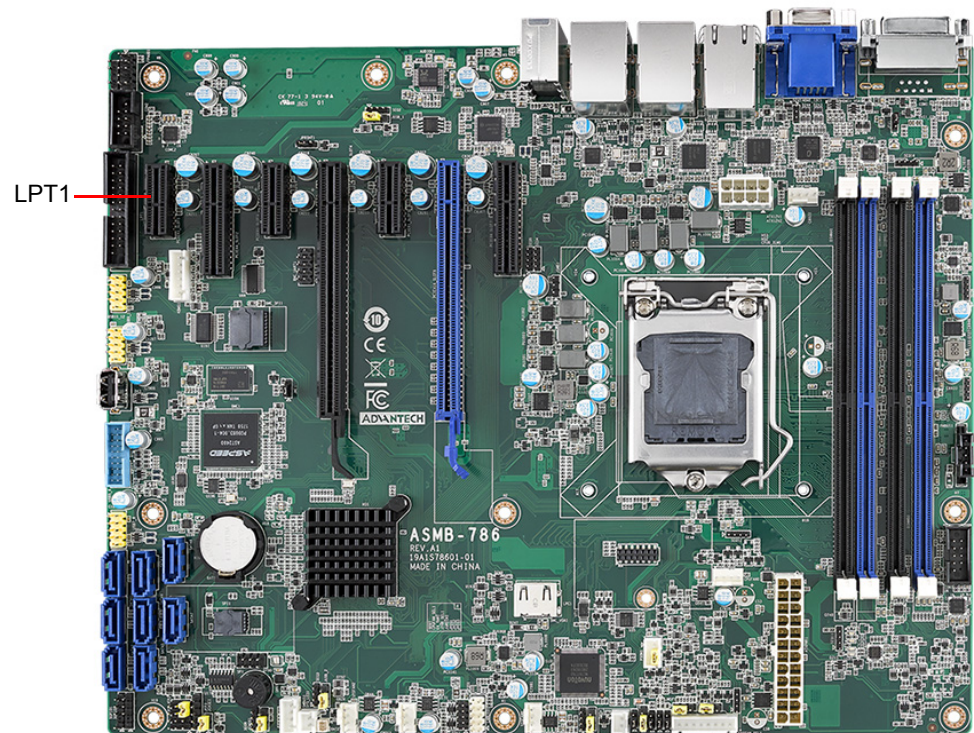

Parallel ports are typically used to connect the motherboard to a printer. The ASMB-786 motherboard includes an onboard parallel port that can be accessed through a 25-pin flat-cable connector.

2.21 PMBUS Connector (PMBUS1)

The PMBUS connector on ASMB-786 is reserved for communicating with the power supply via BMC (G4 SKU).

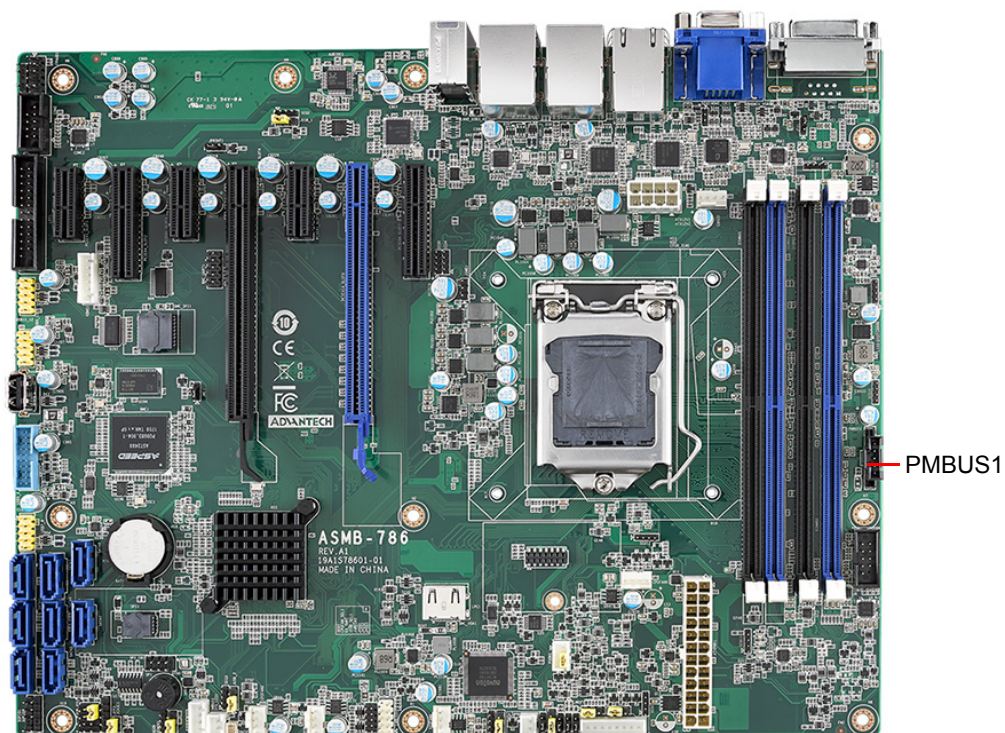

Chapter 3

BIOS Operation

3.1 Introduction

With the AMI BIOS Setup program, users can modify the BIOS settings and control the special system features. The Setup program features a number of menus with multiple options for adjusting the configuration or enabling or disabling the special features. This chapter explains the basic navigation of the ASMB-786 BIOS Setup screens.



Figure 3.1 Main BIOS Setup Screen

The AMI BIOS ROM features a built-in Setup program that allows users to modify the basic system configuration. All configuration data is stored in NVRAM to ensure the Setup information is retained when the power is turned off.

3.2 Entering BIOS Setup

Press or <Esc> at system bootup to access the AMI BIOS Setup utility. Upon entering the utility, the Main BIOS Setup screen is displayed onscreen (as shown in Figure 3.2).

Users can always return to the Main setup screen by navigating to the Main tab. There are two Main Setup options, as explained in this section.

3.2.1 Main Menu

Press or <Esc> at system bootup to enter AMI BIOS CMOS Setup utility.

Use the arrow keys to navigate among the items and press <Enter> to select an item or enter a sub-menu.



Figure 3.2 Main BIOS Setup Screen

The Main BIOS Setup screen comprises two main frames. The left frame displays all the options that can be configured. Grayed-out options cannot be configured; options shown in blue can be configured. The right frame displays the key legend.

Above the key legend is an area reserved for text messages. When an option is selected in the left frame, the option will be highlighted in white and may have an accompanying text message.

3.2.2 System Time/System Date

Use this option to change the system time and date. Highlight the System Time or System Date options using the <Arrow> keys. Enter new values via the keyboard. Press the <Tab> key or the <Arrow> keys to move between fields. The date must be entered in MM/DD/YY format. The time must be entered in HH:MM:SS format.

3.3 Advanced BIOS Features

Select the Advanced tab of the BIOS Setup menu to access the Advanced BIOS Setup options. Using the <Arrow> keys, select any of the items in the left frame of the screen, such as CPU configuration, to access the sub menu for that item.

This section describes all Advanced BIOS Setup options and their sub menus, and provides images of the Advanced BIOS Setup screens for user reference.

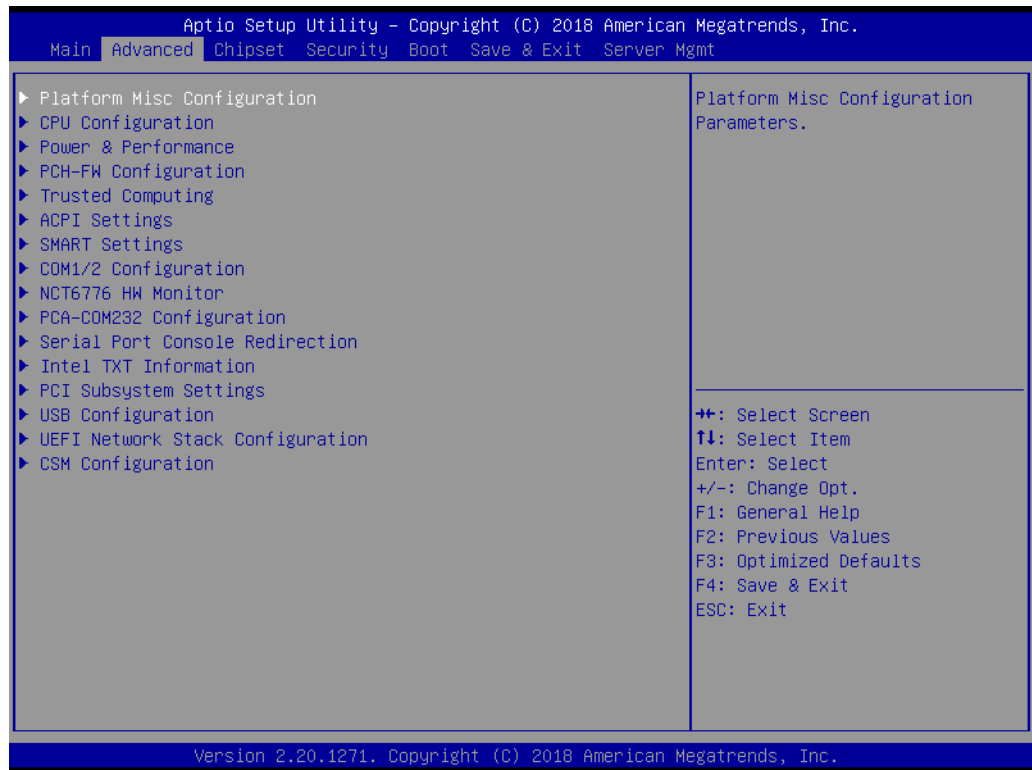

Figure 3.3 Advanced Tab of the BIOS Setup Screen

3.3.1 Platform Misc Configuration

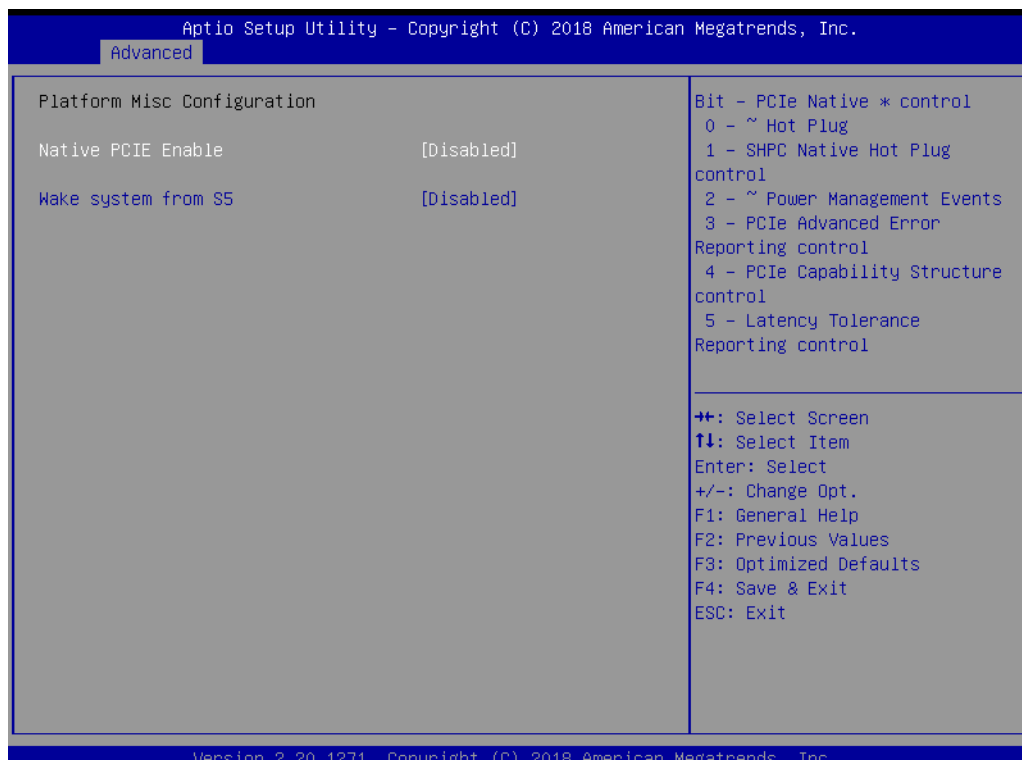
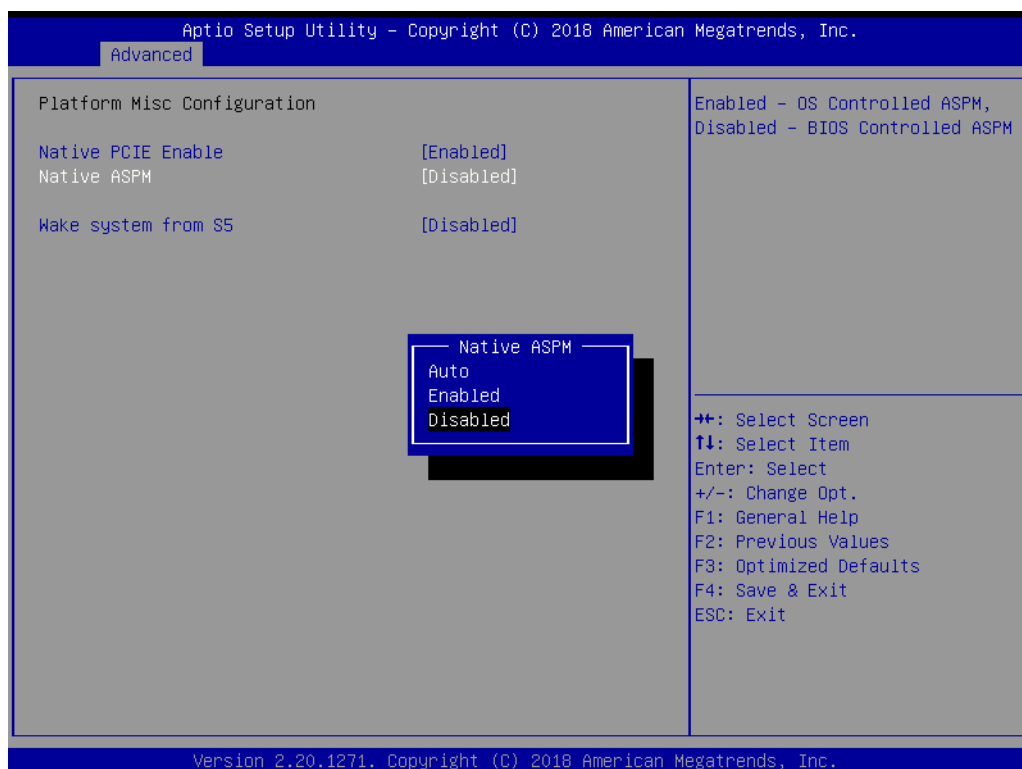

Figure 3.4 Platform Misc Configuration Screen

- **Native PCIE Enable**
This item allows users to Enable/Disable PCIe native control. When this item is enabled, “Native ASPM” can be set as Enabled for OS control or Disabled for BIOS control. The default setting is Disabled for BIOS control.
- **Wake System From S5**
This item allows users to Enable/Disable “System Wake On Alarm Event”. When Enabled, the system will wake if an alarm event is detected.



3.3.2 CPU Configuration



Figure 3.5 CPU Configuration Screen

- **Hardware Prefetcher**
This item allows users to Enable/Disable the MLC streamer prefetcher. Hardware-based prefetching is a technique that involves fetching instructions and/or data from the system memory to the CPU cache memory before it is actually needed to improve the load-to-use latency.
- **Adjacent Cache Line Prefetch**
This item allows users to Enable/Disable adjacent cache line prefetching. The Adjacent Cache Line Prefetch mechanism, like automatic hardware-based prefetching, operates without programmer intervention. When Enabled through the BIOS, two 64-byte cache lines are fetched into a 128-byte sector, regardless of whether the additional cache line has been requested or not.
- **Intel® (VMX) Virtualization Technology**
This item allows users to Enable/Disable the Intel® Virtualization Technology (IVT) extension. IVT allows multiple operating systems to run simultaneously on the same system by creating virtual machines, each running its own x86 operating system.
- **Active Processor Cores**
This item allows users to set the number of cores Enabled for each processor package.
- **Advanced Encryption Standard (AES)**
This item allows users to Enable/Disable the Advanced Encryption Standard instruction set.

3.3.3 Power and Performance



Figure 3.6 CPU - Power Management Control Screen

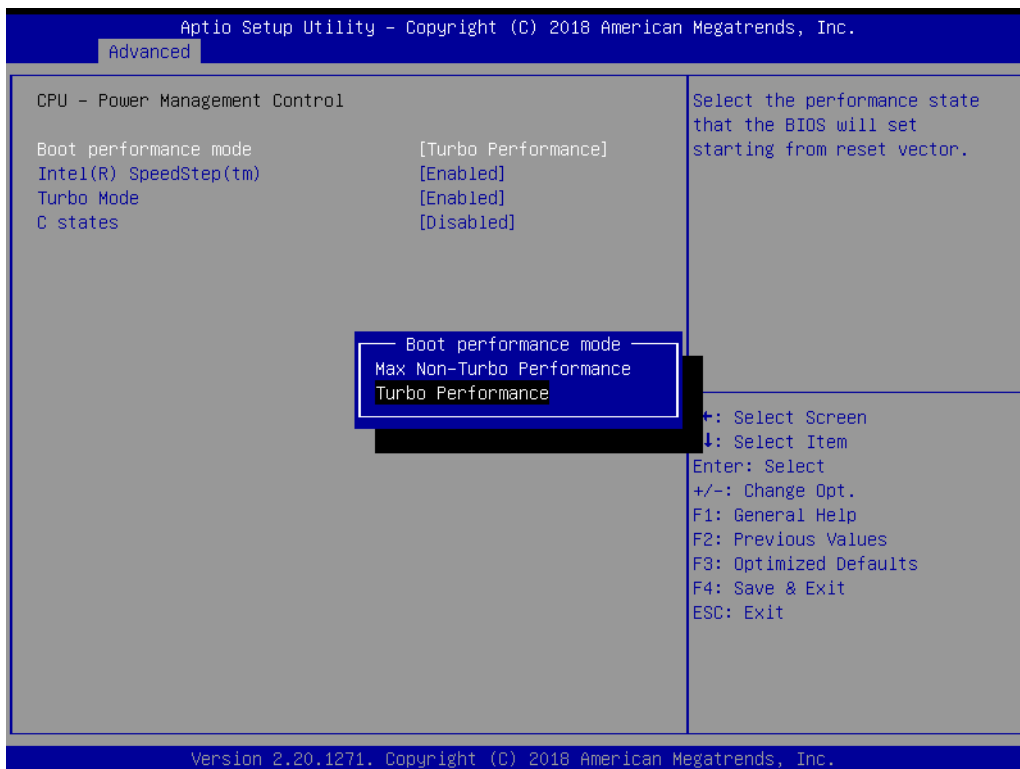

- **Boot Performance Mode**
This item allows users to select the performance state that the BIOS will set before OS handoff.
- **Intel® SpeedStep™**
This item allows users to Enable/Disable support for more than two frequency ranges.

- **Turbo Mode**
This item allows users to Enable/Disable turbo mode (Intel® SpeedStep™ or Intel® SpeedShift™ must be available and enabled).
- **C States**
This item allows users to Enable/Disable CPU power management. This function instructs the CPU to go into a C state when not 100% utilized.

3.3.4 PCH-FW Configuration

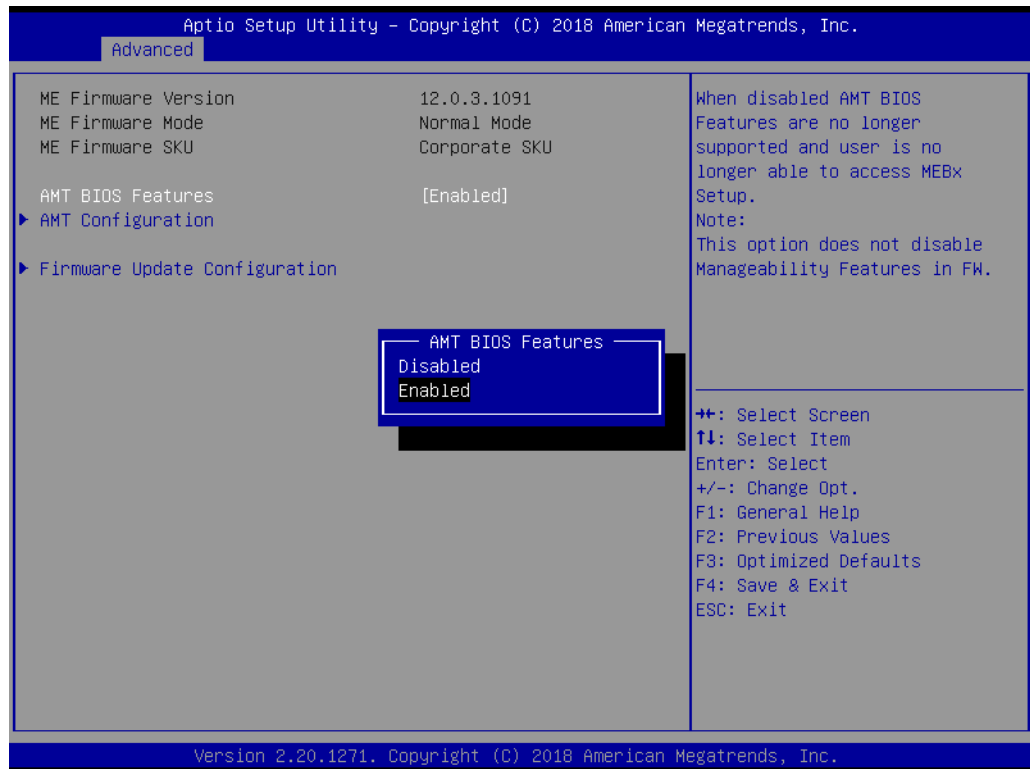

Figure 3.7 PCH-FW Configuration Screen

This screen shows the Intel® Management Engine configuration settings.

3.3.4.1 AMT Configuration

■ ASF Support

This item allows users to Enable/Disable Alert Standard Format (ASF) support.

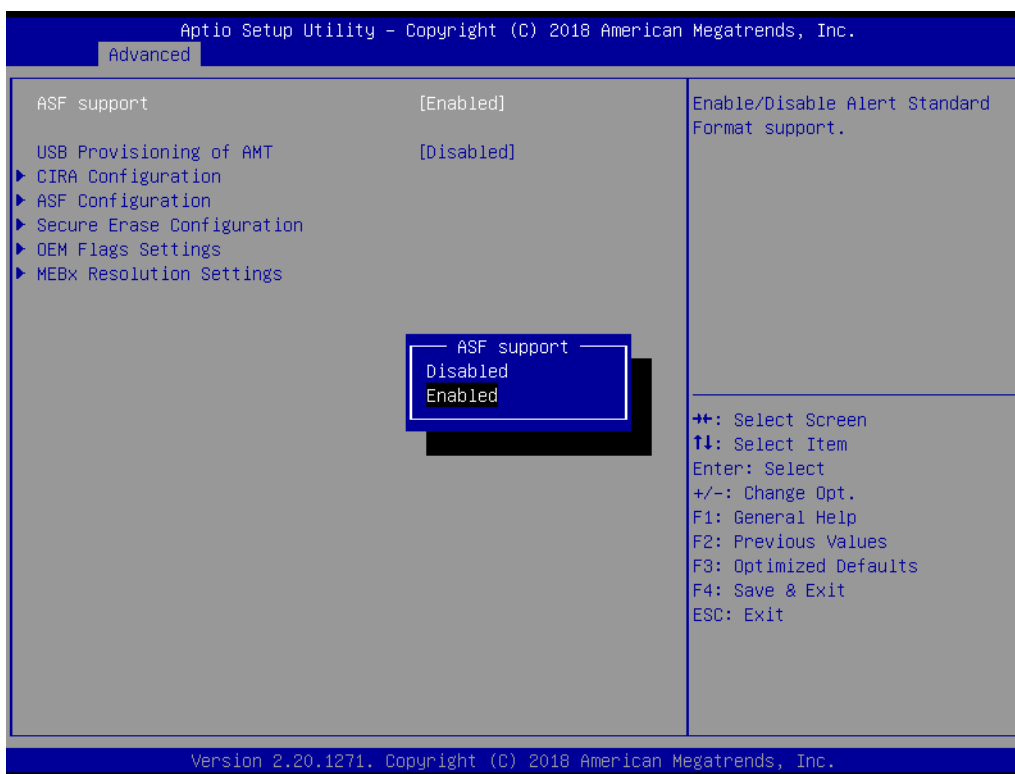

■ USB Provisioning of AMT

This item allows users to Enable/Disable AMT USB provisioning.

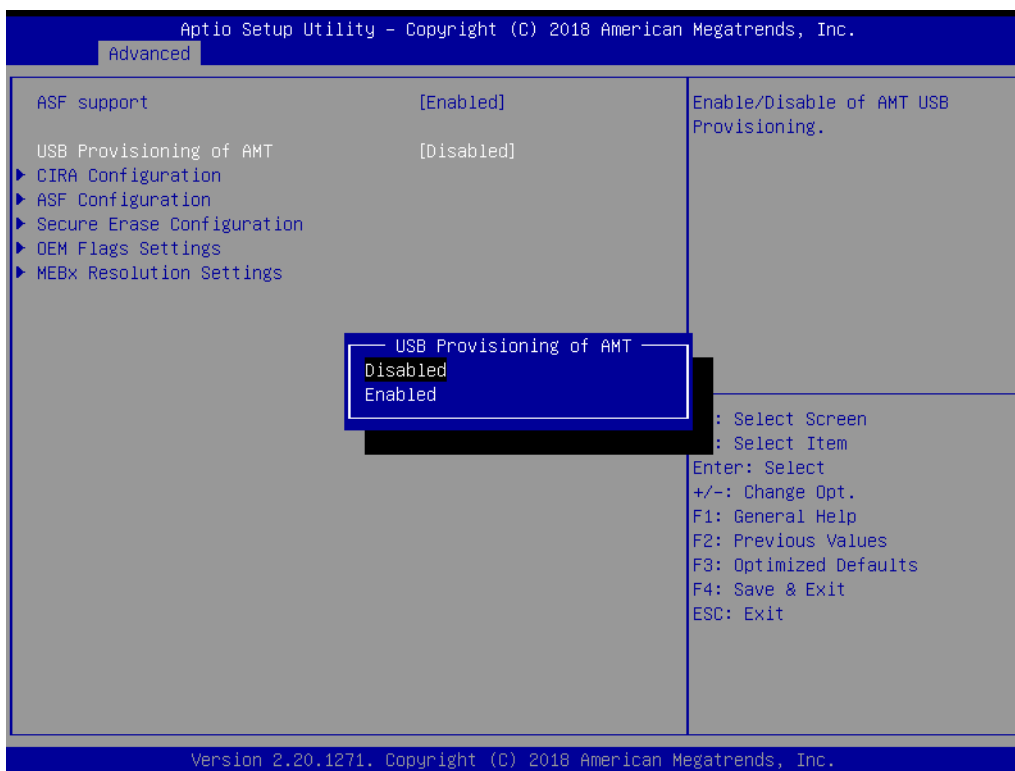

■ **Activate Remote Assistance Process**

This item allows users to Enable/Disable the trigger CIRA boot function. Network access must be activated first from the MEBx configuration menu.

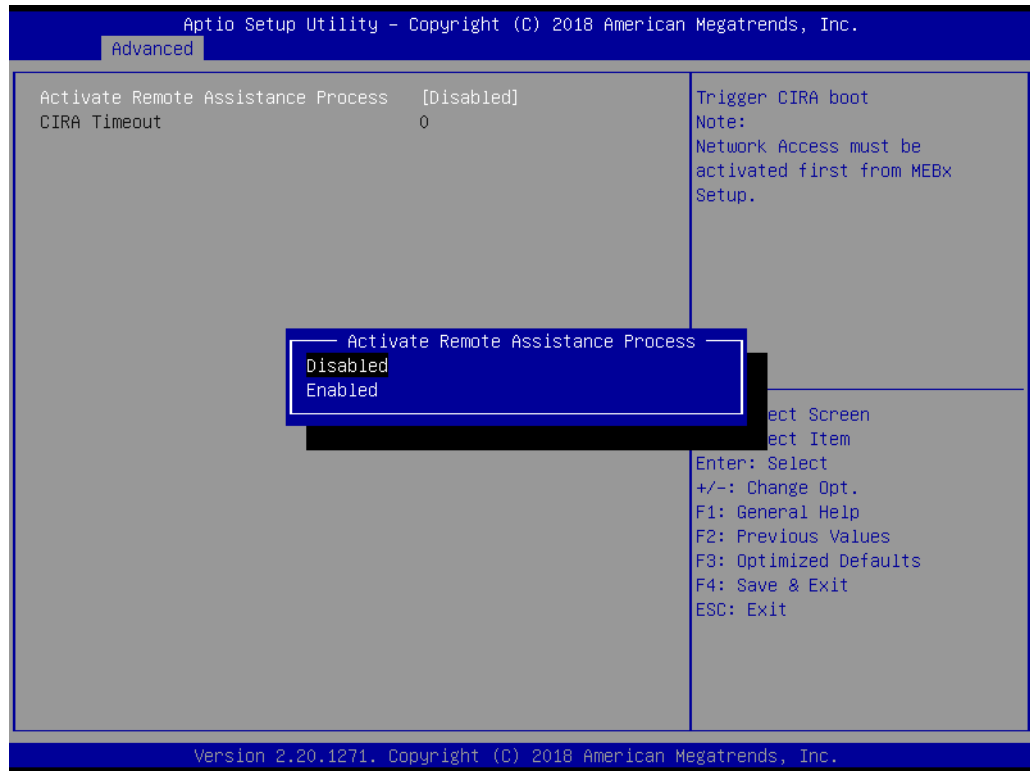

3.3.4.2 ASF Configuration

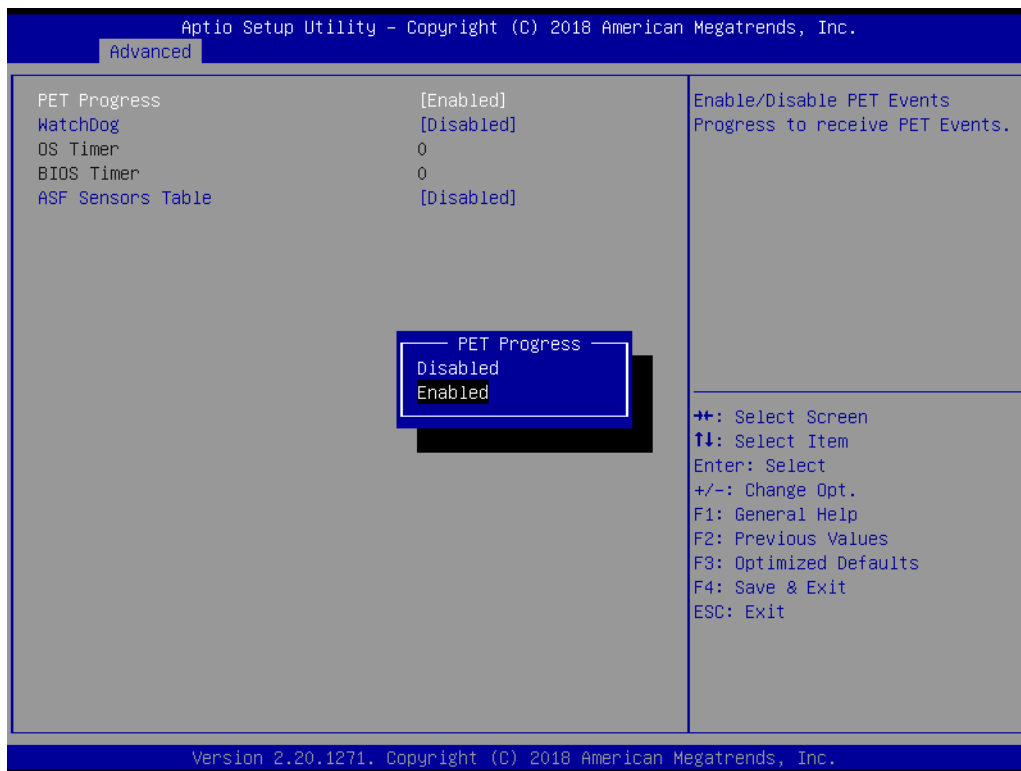

- **PET Progress**
This item allows users to Enable/Disable the PET Events Progress function in order to receive notification of PET events.
- **WatchDog**
This item allows users to Enable or disable the watchDog timer.
- **ASF Sensor Table**
This item allows users to add an ASF sensor table into an ASF ACPI table.

3.3.4.3 Secure Erase Configuration

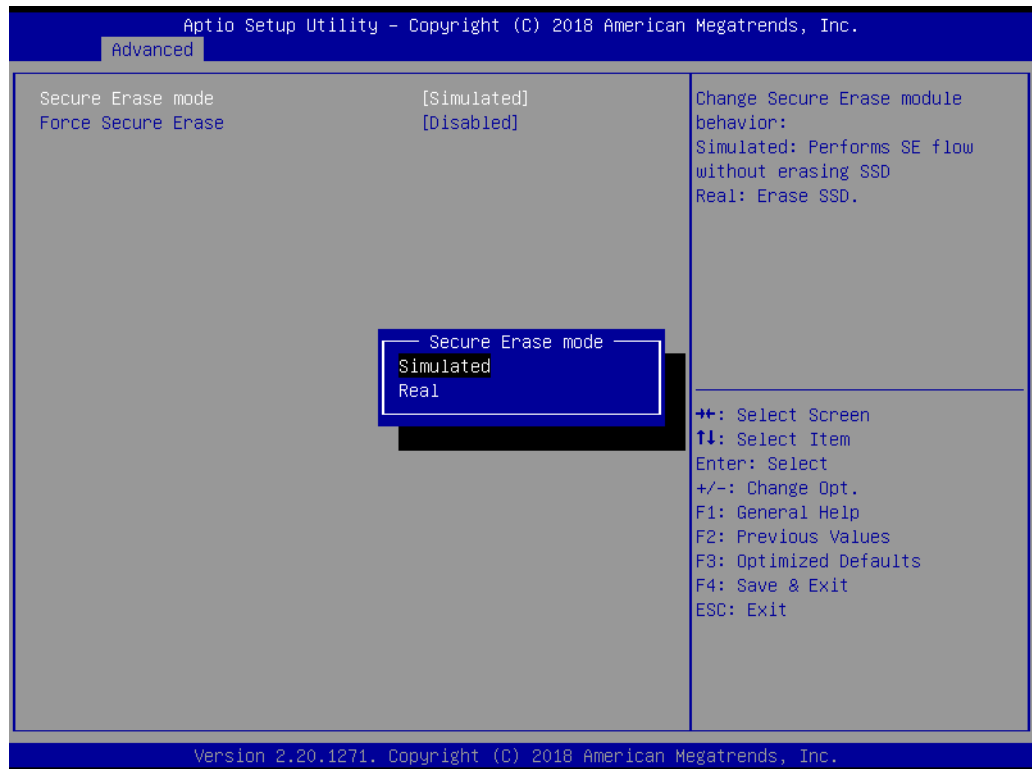

- **Secure Erase Mode**
This item allows users to set the Secure Erase Mode as “Simulated” or “Real”.
- **Force Secure Erase**
This item allows users to Enable/Disable Force Secure Erase on next bootup.

3.3.4.4 OEM Flag Settings

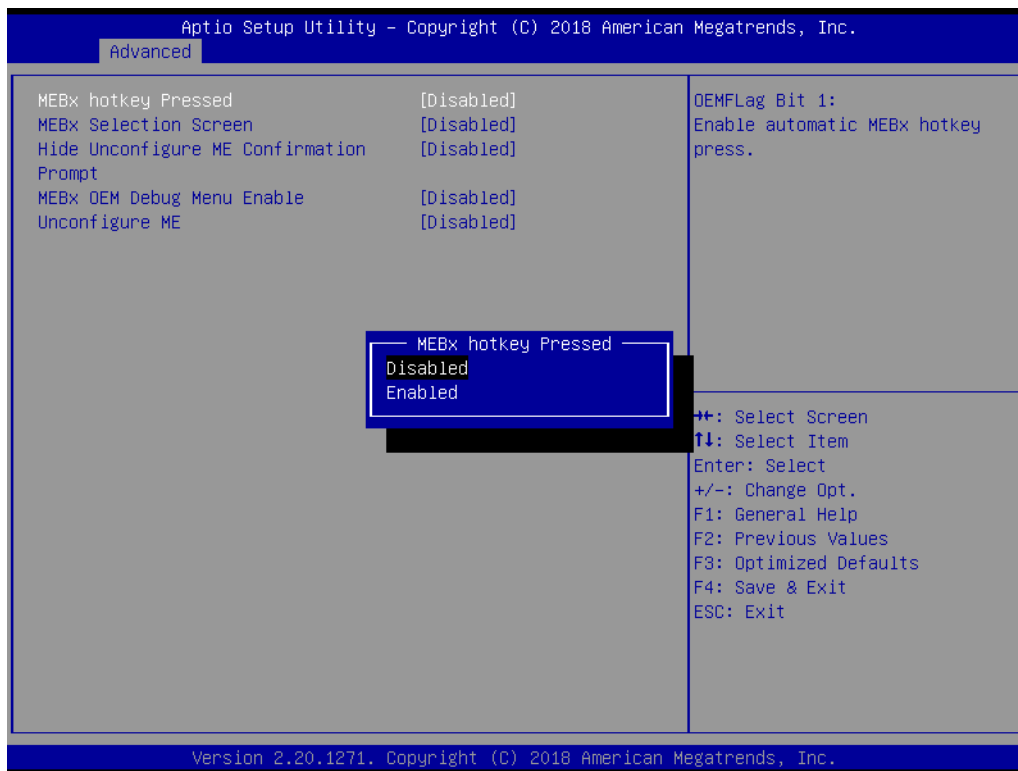

- **MEBx Hotkey Pressed**
This item allows users to Enable/Disable automatic MEBx hotkey pressing.
- **MEBx Selection Screen**
This item allows users to Enable/Disable the MEBx selection screen. Press 1 to enter the ME configuration screens. Press 2 to initiate a remote connection (network access must be activated from the MEBx configuration menu for this screen to be displayed).
- **Hide Unconfigure ME Confirmation Prompt**
This item allows users to Hide/Show the Unconfigure ME Confirmation prompt when attempting ME unconfiguration.
- **MEBx OEM Debug Menu Enable**
This item allows users to Enable/Disable the OEM debug menu in MEBx.
- **Unconfigure ME**
This item allows users to Enable/Disable to unconfigure the ME by resetting the MEBx password to the default.

3.3.4.5 MEBx Resolution Settings

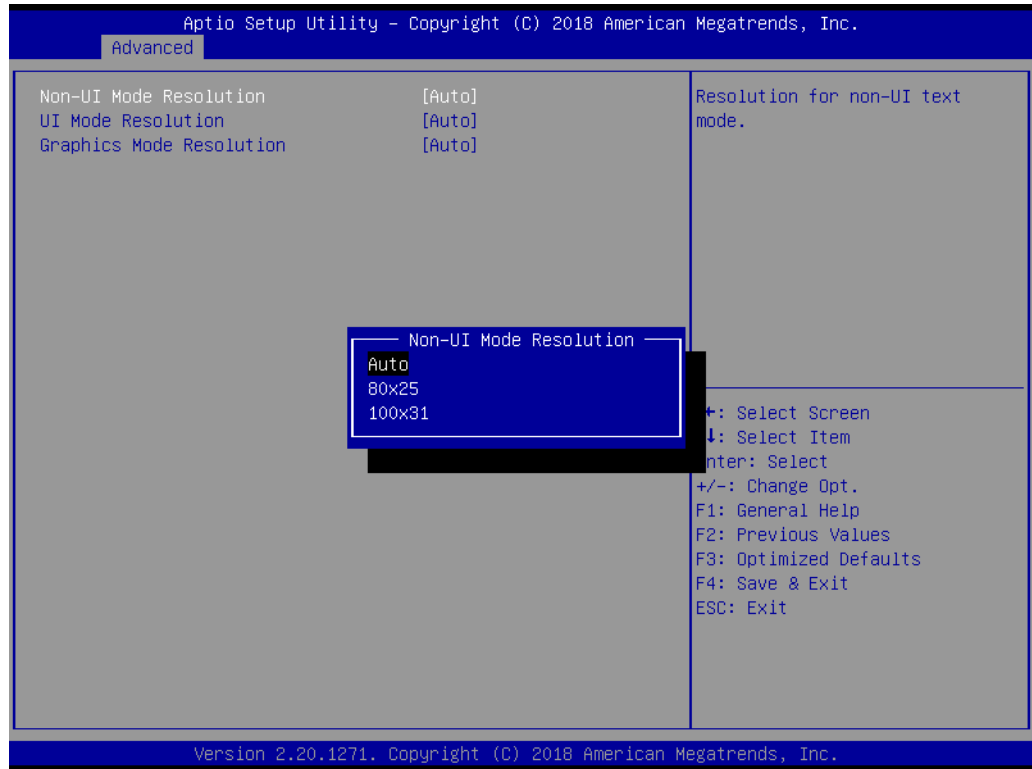

- **Non-UI Mode Resolution**
This item allows users to adjust the resolution for Non-UI text mode.
- **UI Mode Resolution**
This item allows users to adjust the resolution for UI text mode.
- **Graphics Mode Resolution**
This item allows users to adjust the resolution for Graphics mode.

3.3.4.6 Firmware Update Configuration

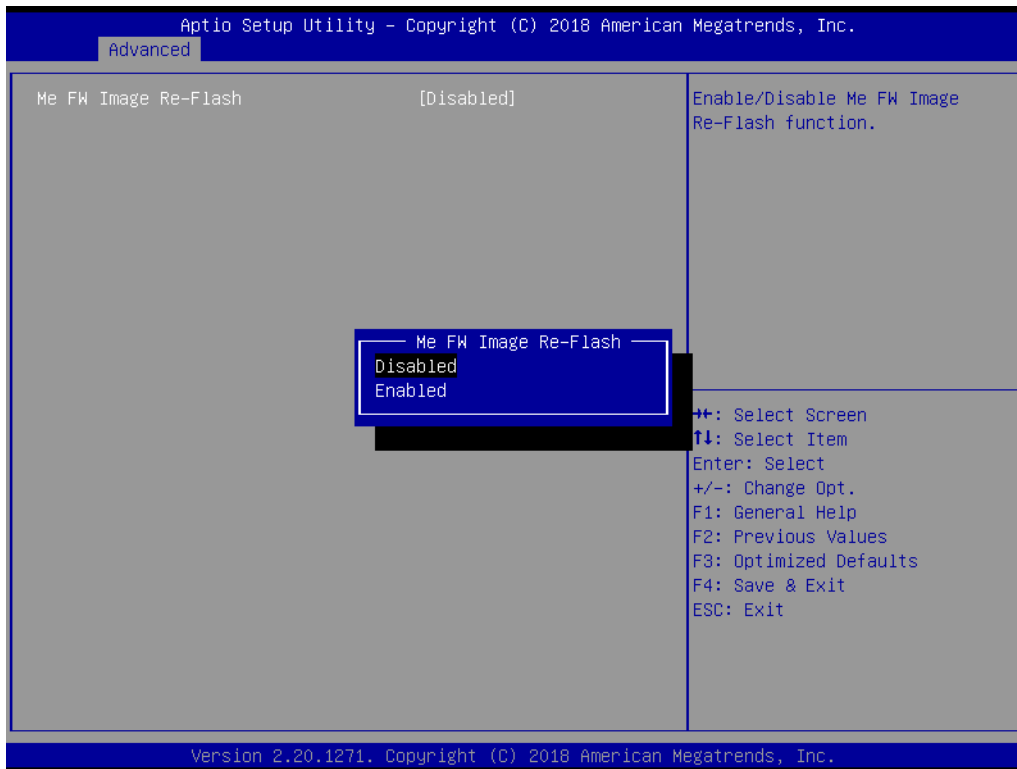

- **ME FW Image Re-Flash**
This item allows users to Enable/Disable the ME FW Image Re-Flash function.

3.3.5 Trusted Computing

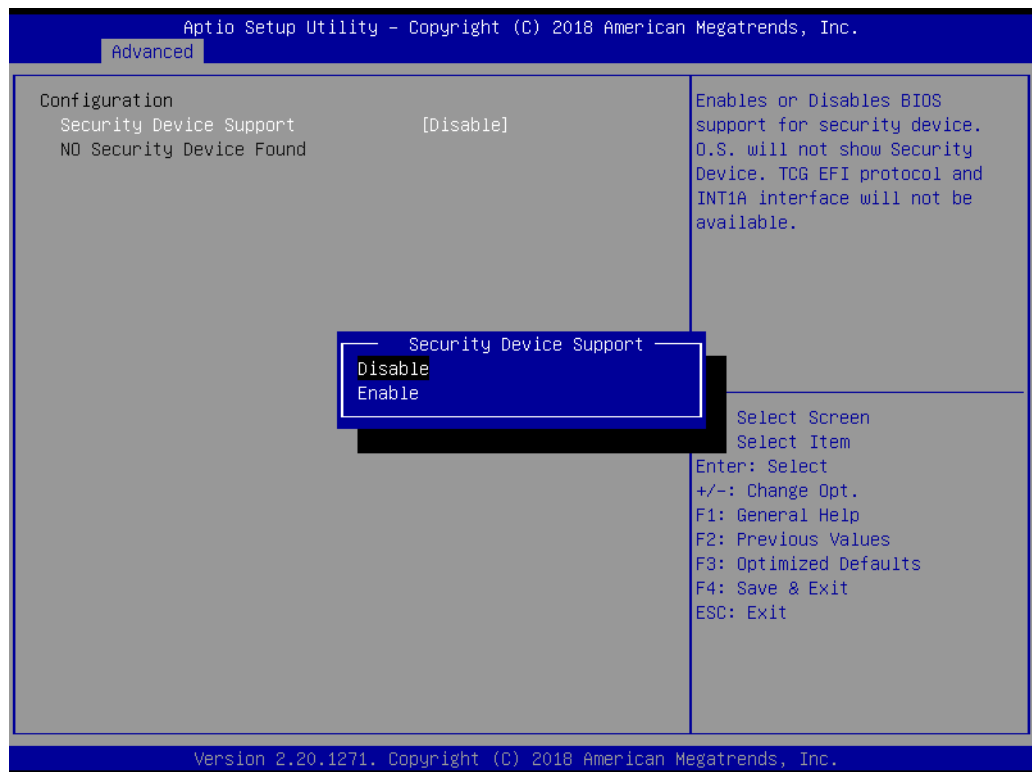

Figure 3.8 TPM Settings Screen

- **Security Device Support**

This item allows users to Enable/Disable TPM support. Additionally, users can integrate an Advantech LPC TPM module to enable TPM function.

3.3.6 ACPI Settings

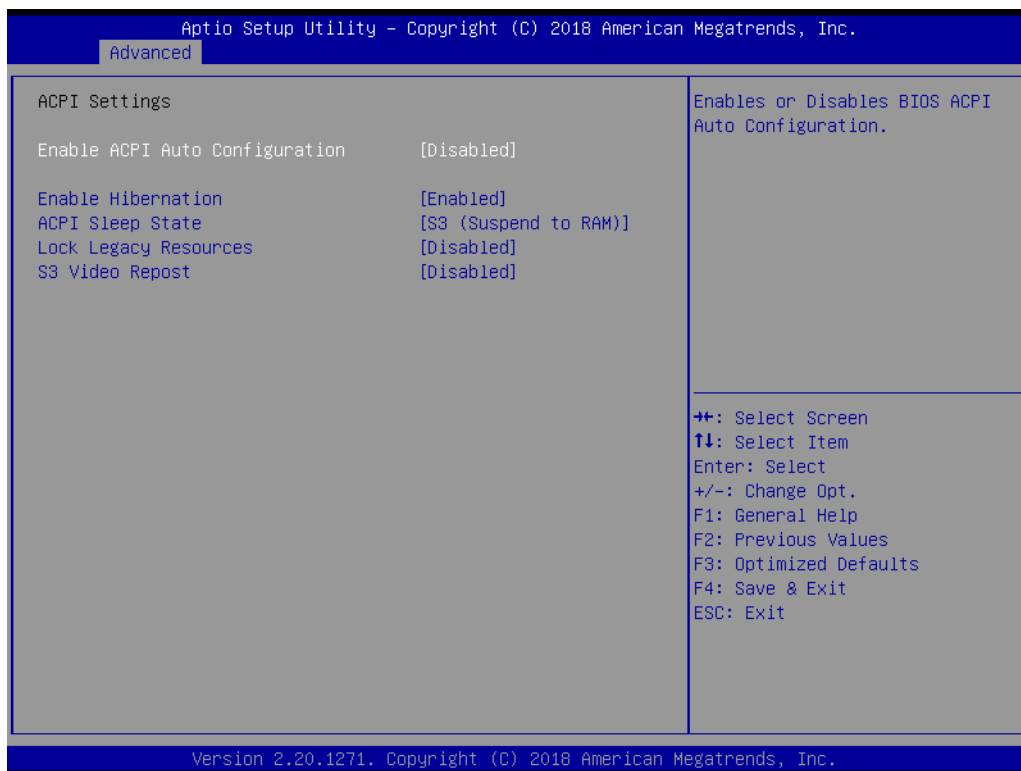

Figure 3.9 ACPI Settings Screen

- **Enable ACPI Auto Configuration**
This item allows users to Enable/Disable automatic BIOS ACPI configuration.
- **Enable Hibernation**
This item allows users to Enable/Disable hibernation (OS/S4 Sleep State). This function may not be available with certain OS.
- **ACPI Sleep State**
This item allows users to specify the ACPI sleep state when the system enters Suspend mode.
- **Lock Legacy Resources**
This item allows users to Enable/Disable legacy resource locking.
- **S3 Video Repost**
This item allows users to Enable/Disable S3 video reposting.

3.3.7 SMART Settings

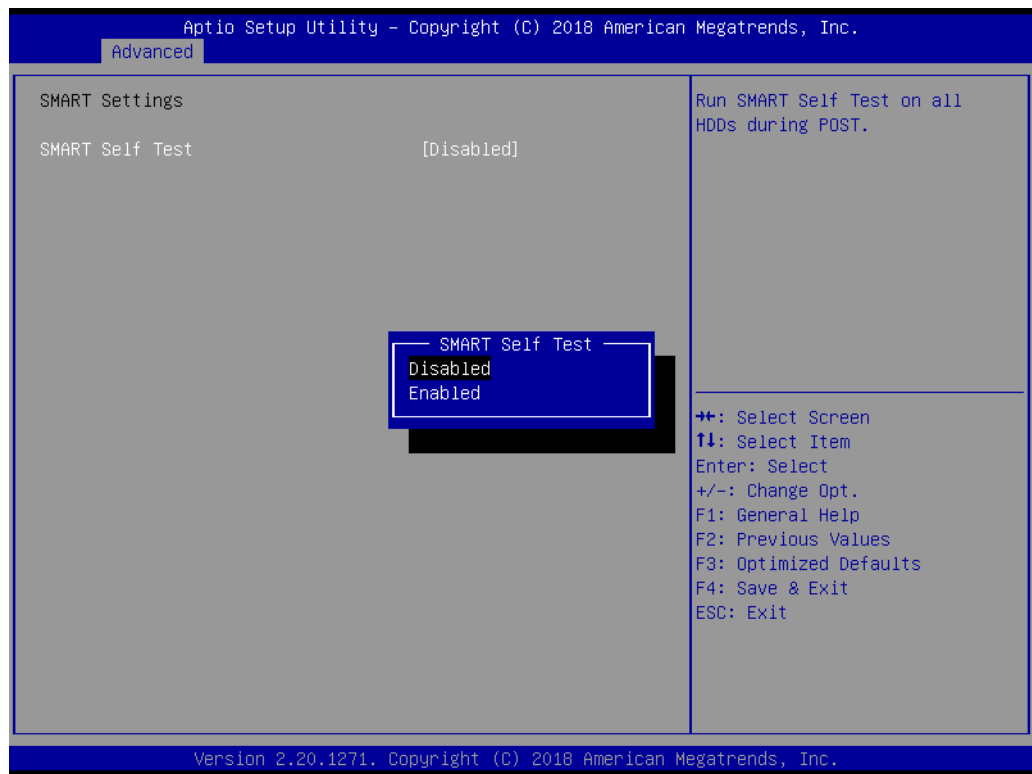

Figure 3.10 SMART Settings Screen

- **SMART Self-Test**

This item allows users to Enable/Disable SMART self-testing for all HDDs during POST.

3.3.8 COM1/2 Configuration

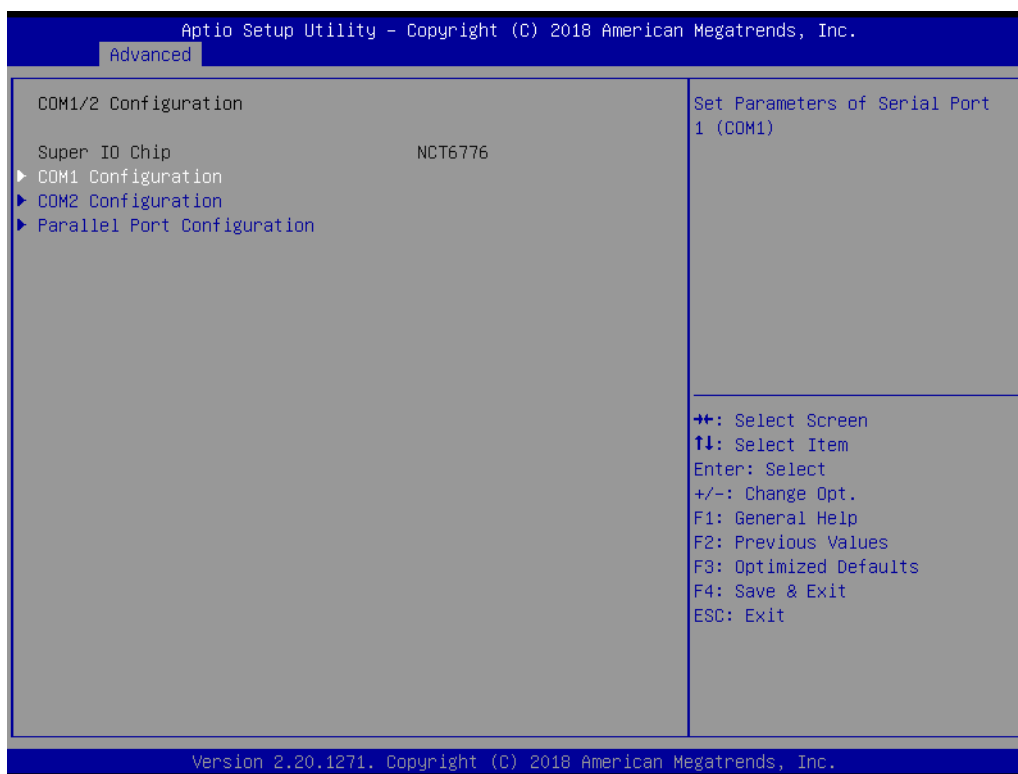
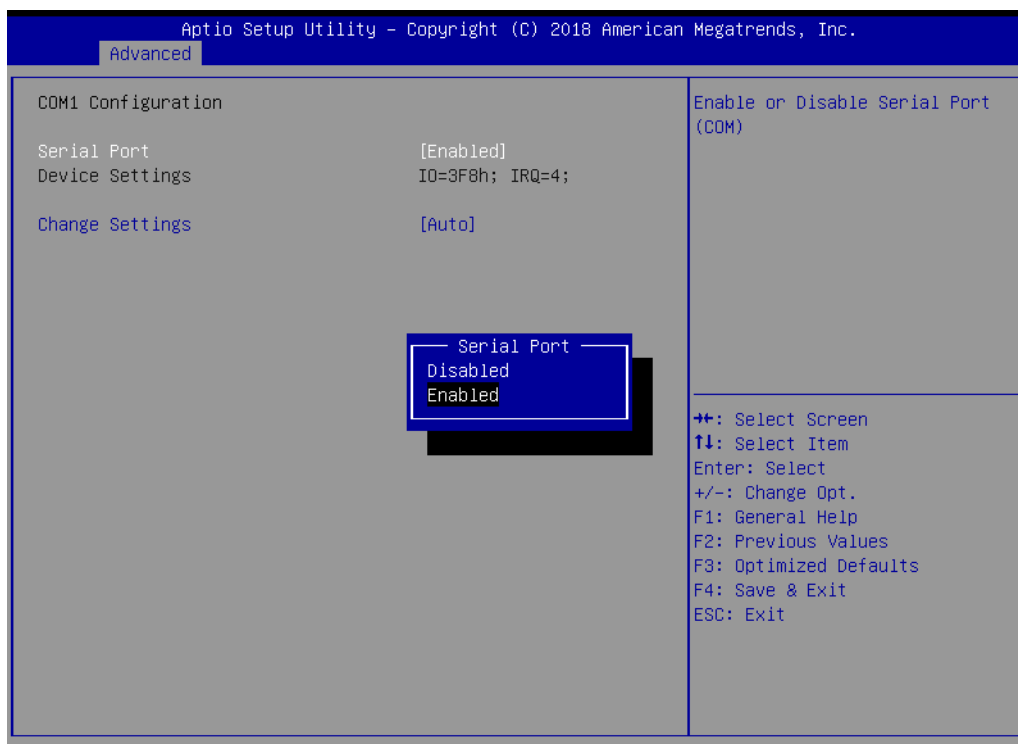
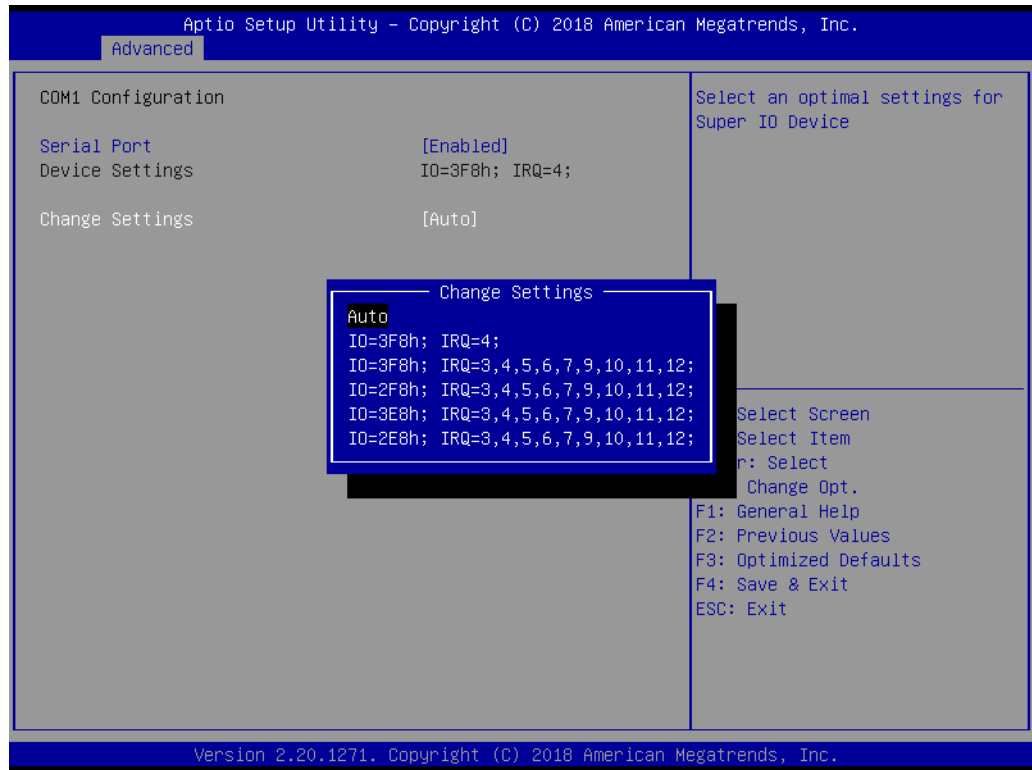

Figure 3.11 COM1/2 Configuration Screen

COM1 Configuration

- **Serial Port**
This item allows users to Enable/Disable serial port COM1.
- **Change Settings**
This item allows users to optimize the super I/O device settings.





COM2 Configuration

- **Serial Port**
This item allows users to Enable/Disable serial port COM2.
- **Change Settings**
This item allows users to optimize the super I/O device settings.

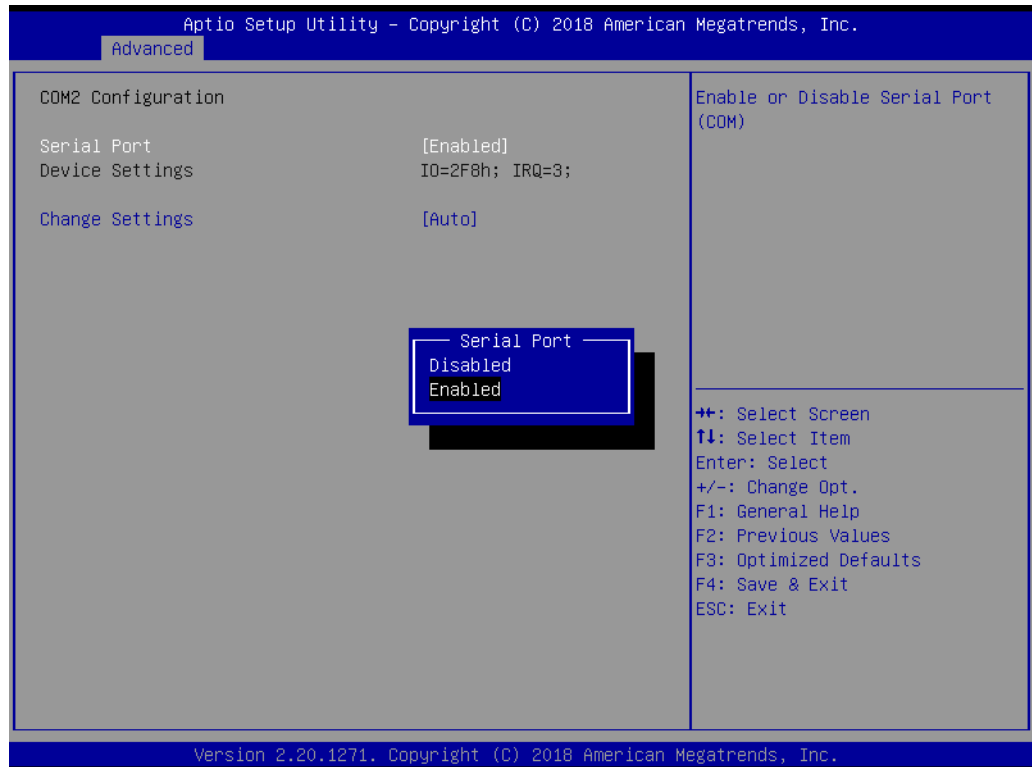

Parallel Port Configuration

- **Parallel Port**
This item allows users to Enable/Disable the parallel port (LPT/LPTE).
- **Change Settings**
This item allows users to optimize the super I/O device settings.
- **Device Mode**
This item allows users to change the printer port mode.

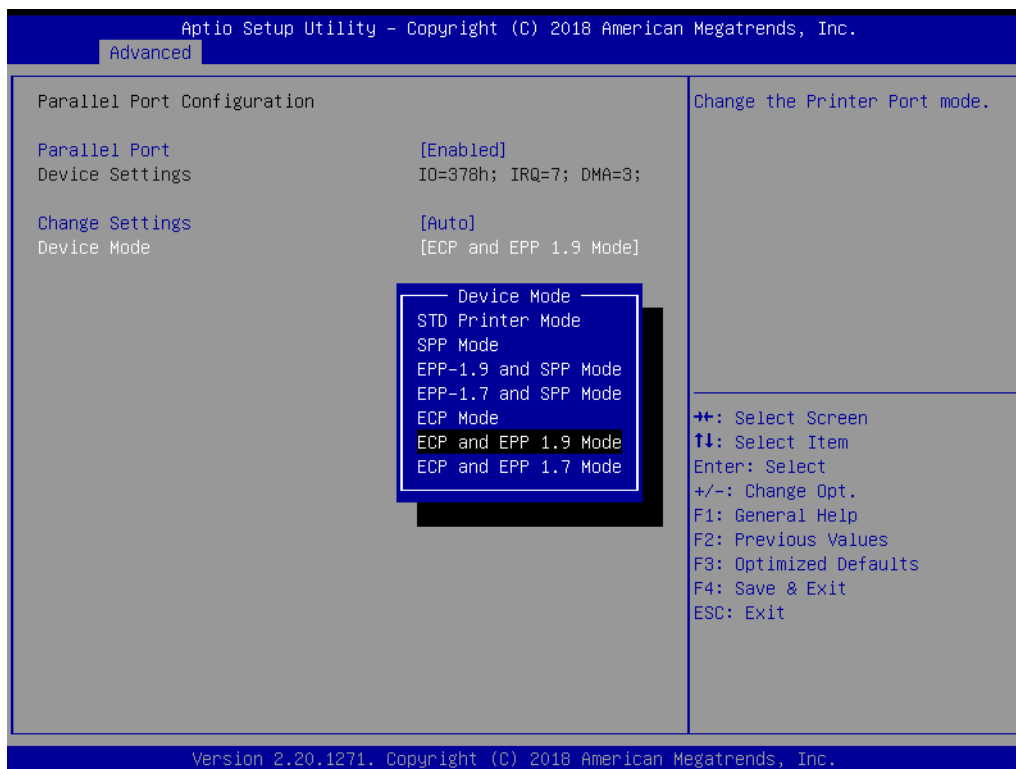
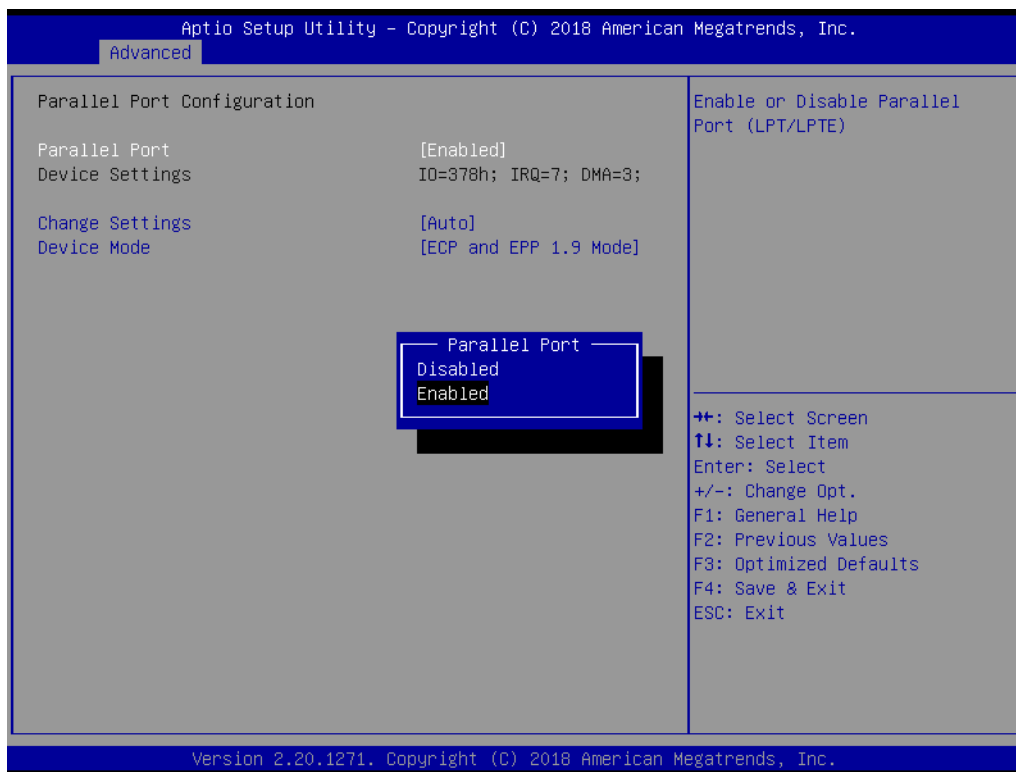

3.3.9 NCT6776 HW Monitor

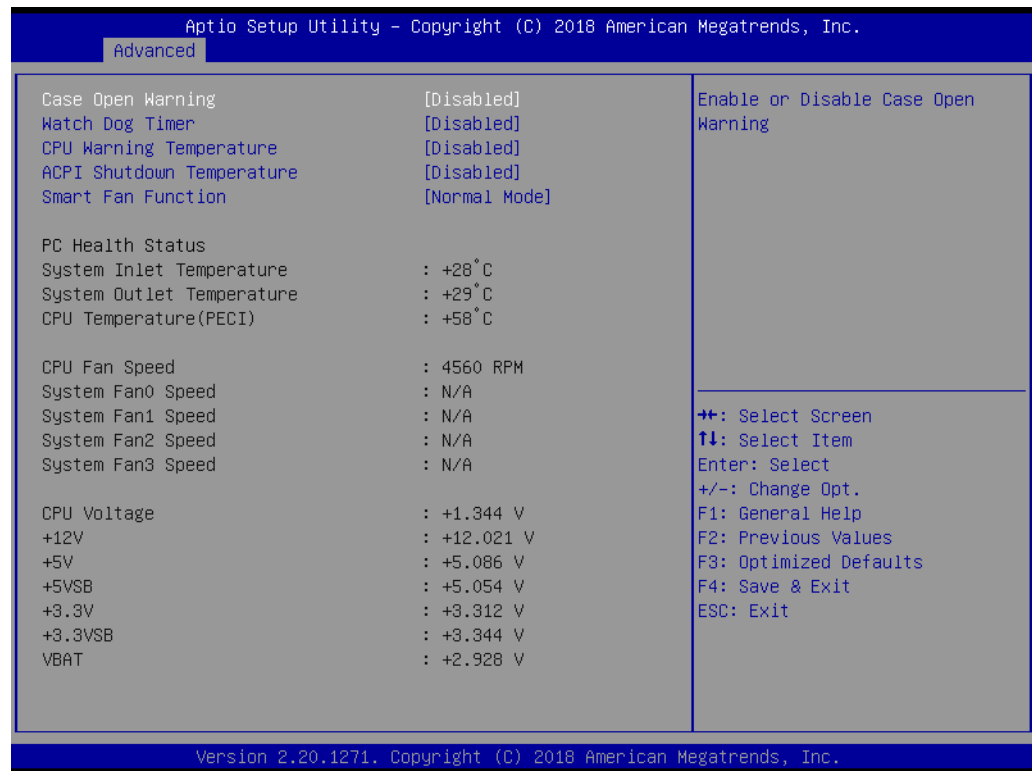
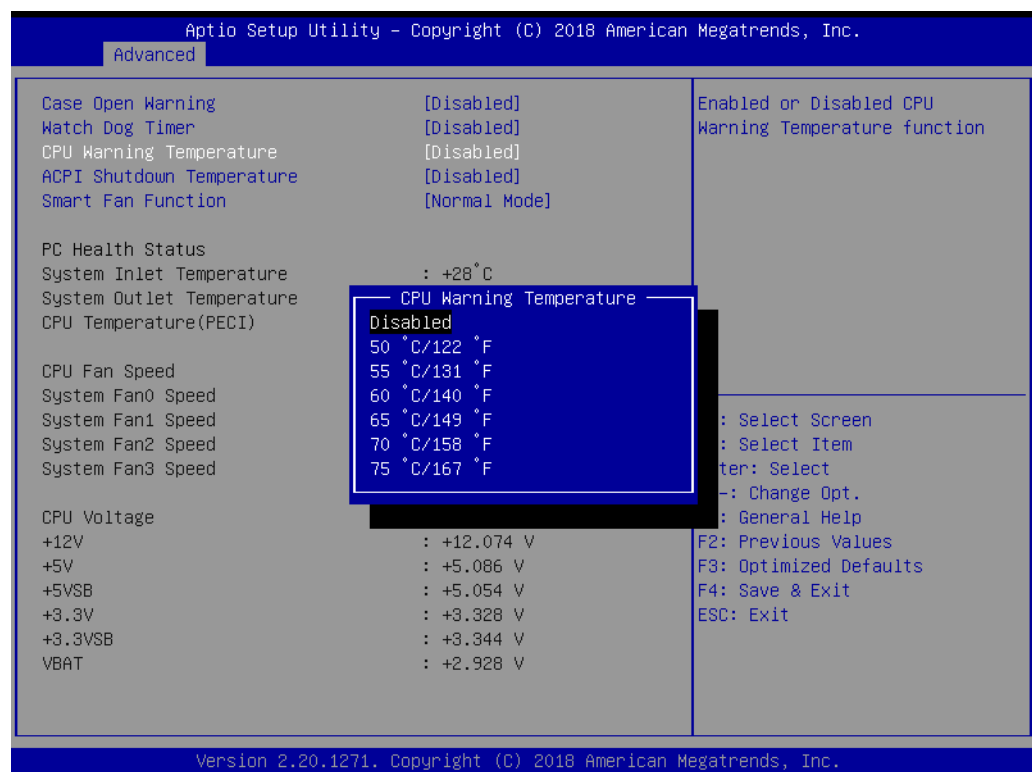

Figure 3.12 PC Health Status Screen

- **CPU Warning Temperature**

This item allows users to set the CPU warning temperature threshold. When the system reaches the warning temperature, an alarm warning will be emitted.



- **ACPI Shutdown Temperature**

This item allows users to set the ACPI shutdown temperature threshold. When the pre-specified shutdown temperature is reached, the system will be automatically shut down by the ACPI OS to prevent damage from overheating.

- **Case Open Warning**

This item allows users to Enable/Disable chassis intrusion monitoring. When Enabled and the case is opened, a warning message will be displayed in the POST screen. Ensure that the board is paired with the chassis kit correctly to facilitate this function.

- **WatchDog Timer**

This item allows users to Enable/Disable the watchdog timer.

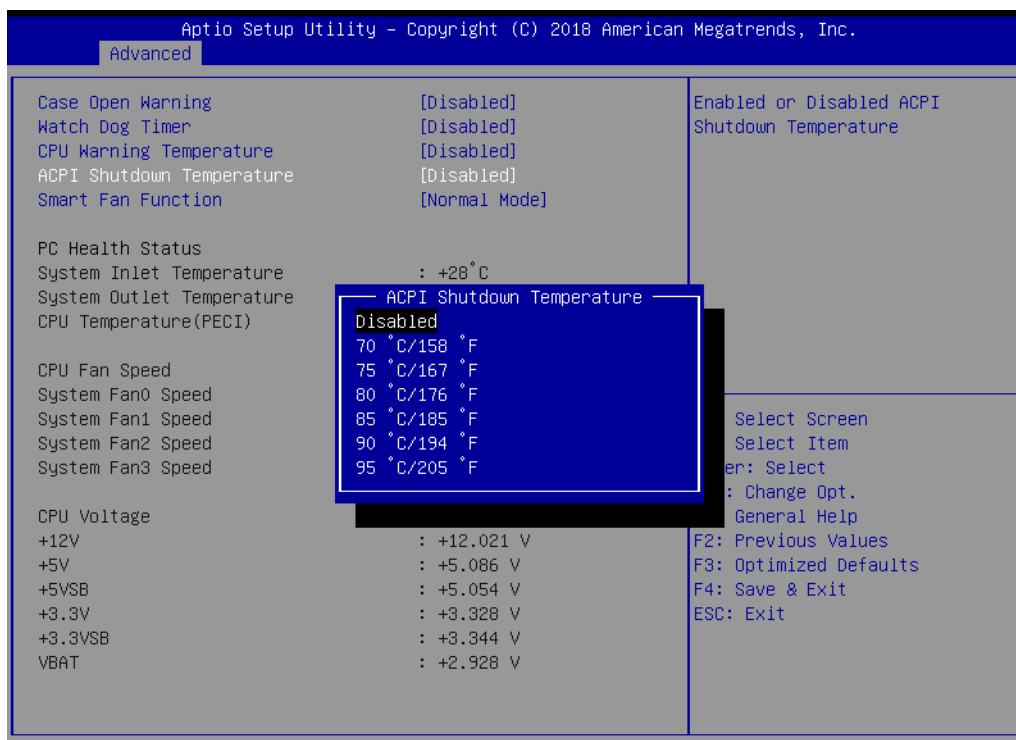

■ Smart Fan Function

This item allows users to select between the three smart fan modes:

1. Normal Mode - The system will adjust the fan speed automatically.
2. Quiet Mode - The fan will rotate at the lowest speed to minimize noise.
3. Disabled - Smart control of fans is Disabled and all fans run at full speed.

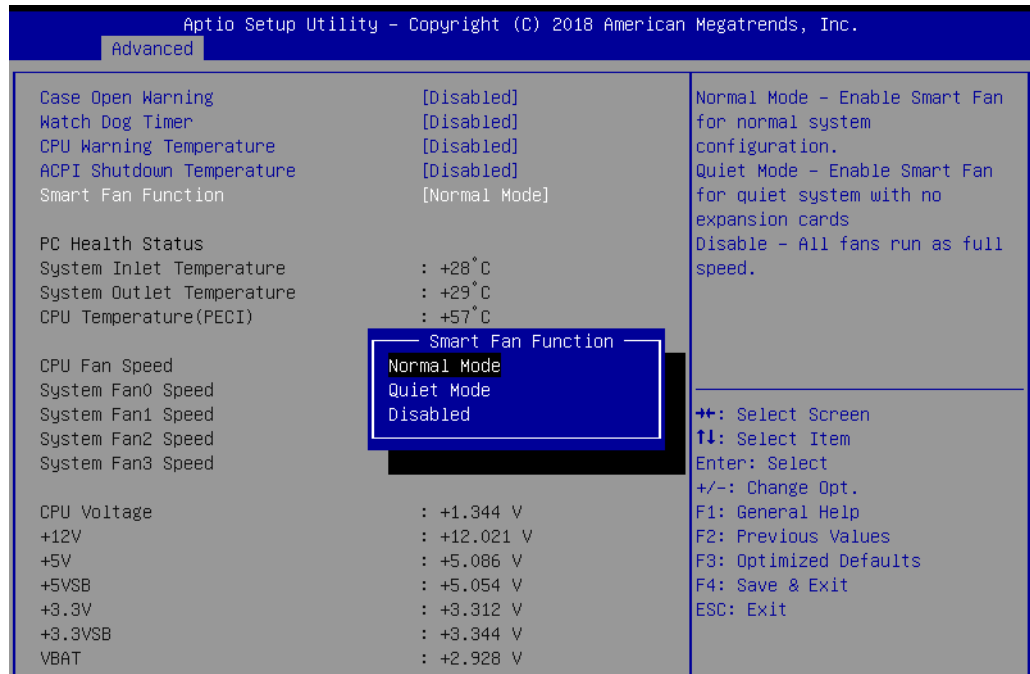

3.3.10 PCA-COM232/COM485 Super I/O Configuration

Note! This item is only available if a PCA COM module is installed.

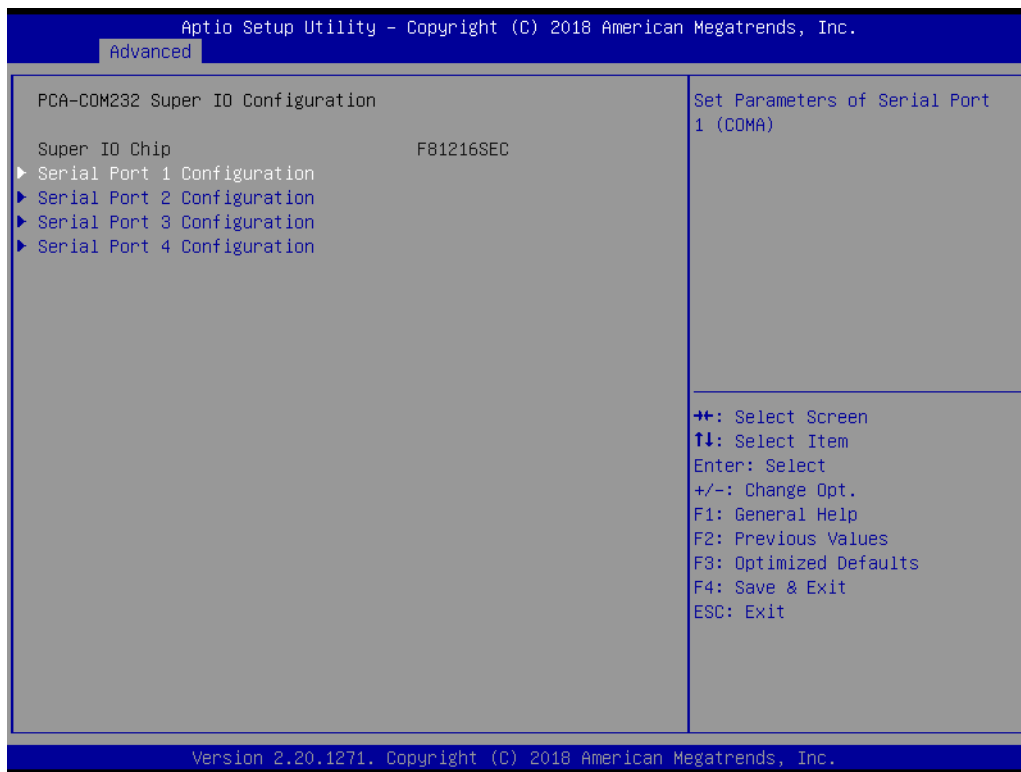
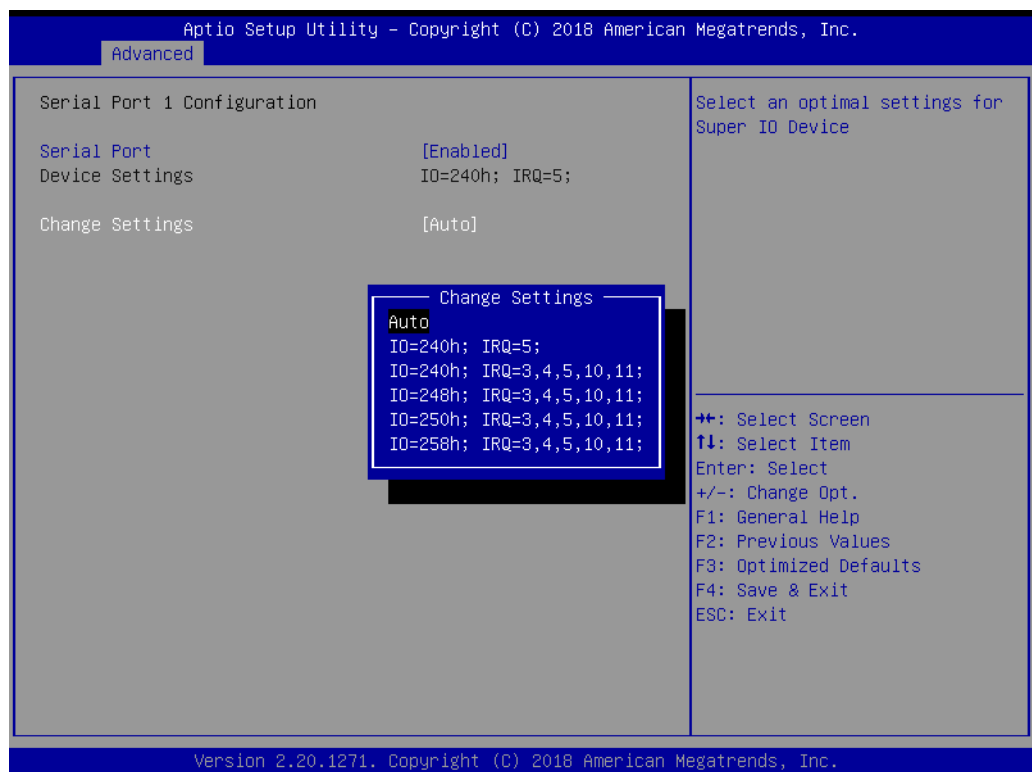
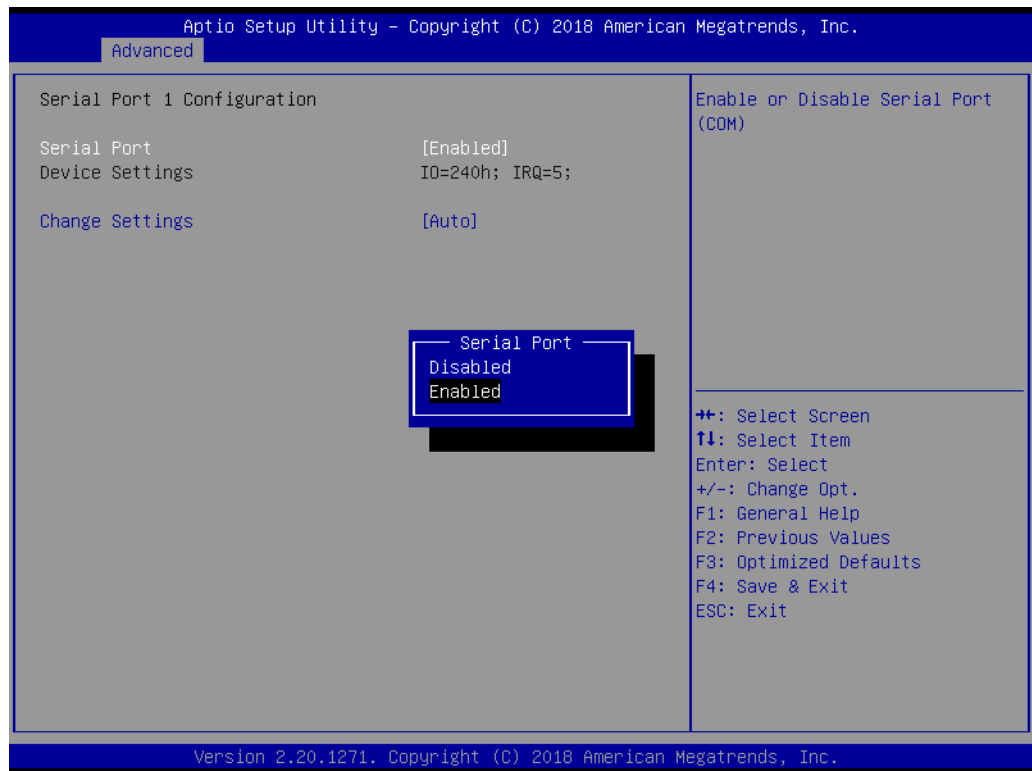

Figure 3.13 PCA-COM Configuration Screen

ASMB-786 can support an extra four COM ports through the LPC connector. To implement this expansion, users must install a PCA-COM232-00A1E or PCA-COM485-00A1E I/O extension module in the LPC connector.



Serial Port 1 Configuration

- **Serial Port**
This item allows users to Enable/Disable Serial Port 1.
- **Change Settings**
This item allows users to set the resource allocation for Serial Port 1.

Serial Port 2 Configuration

- **Serial Port**
This item allows users to Enable/Disable Serial Port 2.
- **Change Settings**
This item allows users to set the resource allocation for Serial Port 2.

Serial Port 3 Configuration

- **Serial Port**
This item allows users to Enable/Disable Serial Port 3.
- **Change Settings**
This item allows users to set the resource allocation for Serial Port 3.

Serial Port 4 Configuration

- **Serial Port**
This item allows users to Enable/Disable Serial Port 4.
- **Change Settings**
This item allows users to set the resource allocation for Serial Port 4.

3.3.11 Serial Port Console Redirection

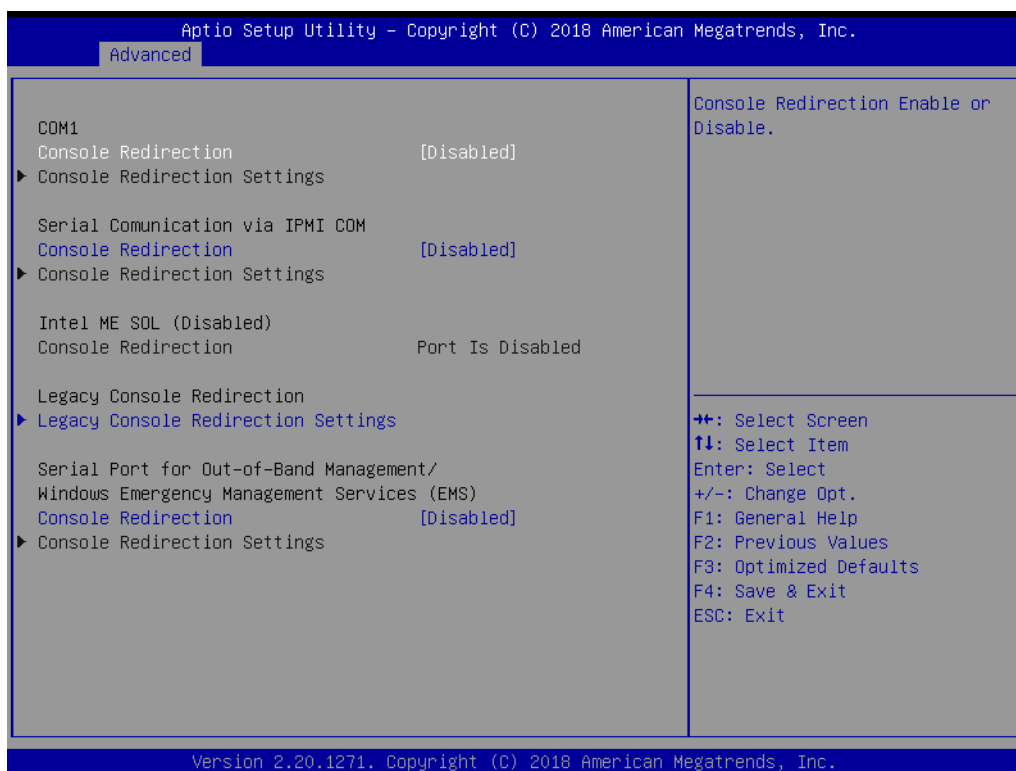
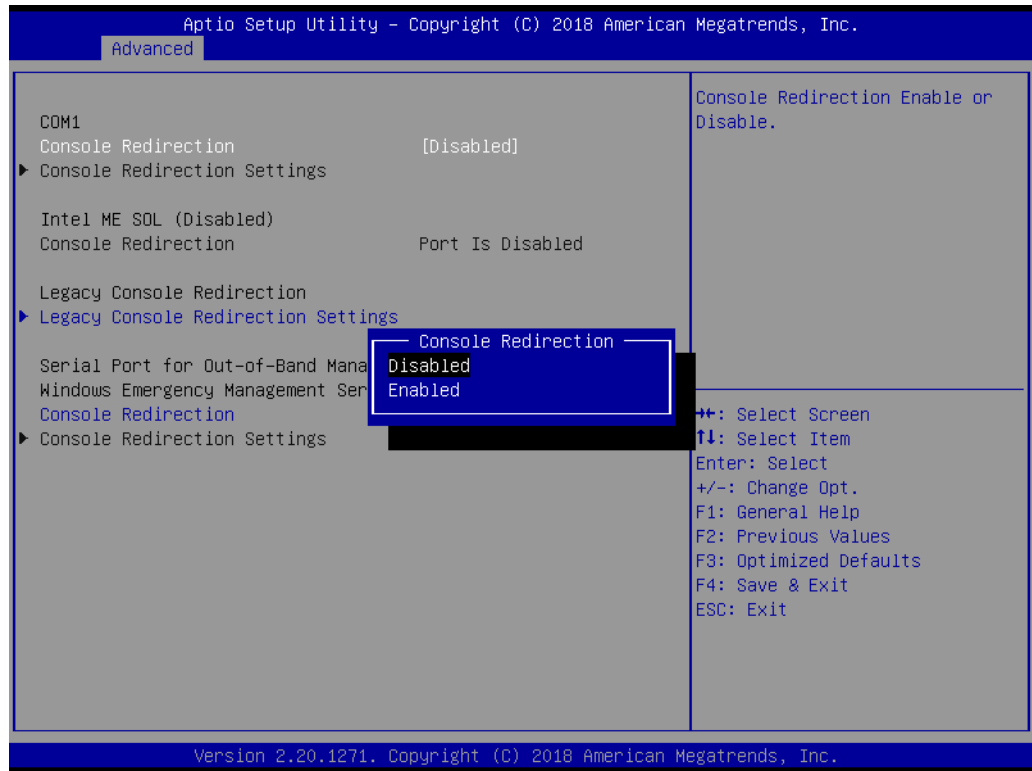
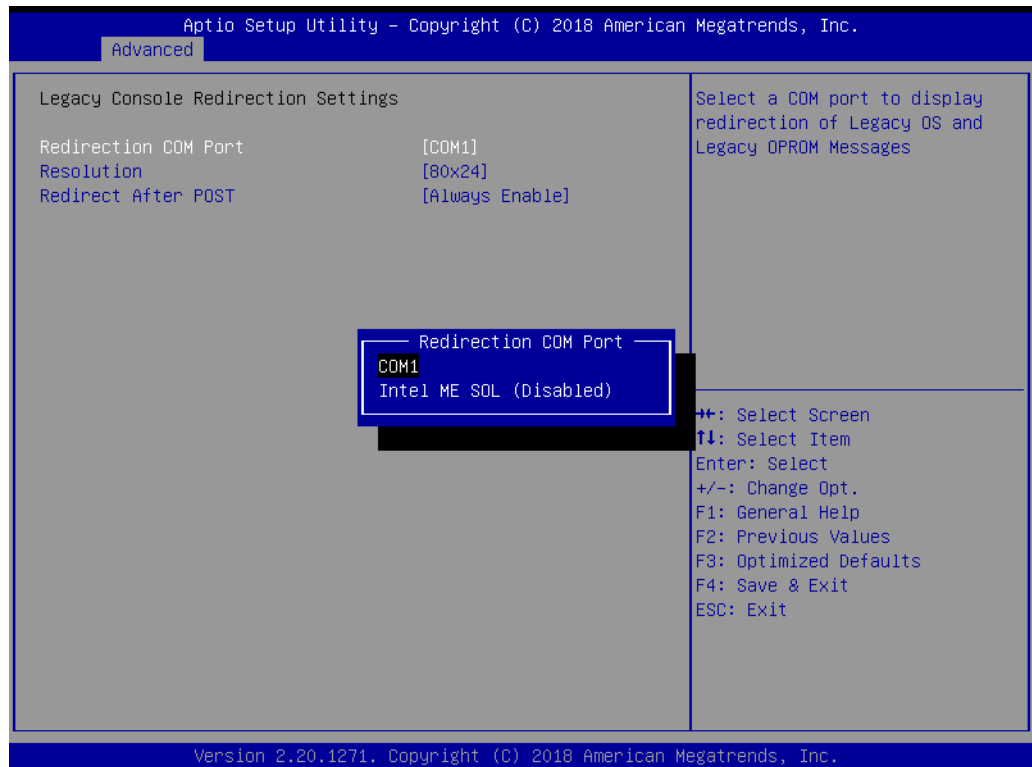

Figure 3.14 Serial Port Console Redirection Screen

- **Console Redirection**
This item allows users to Enable/Disable console redirection.



■ Legacy Console Redirection Settings



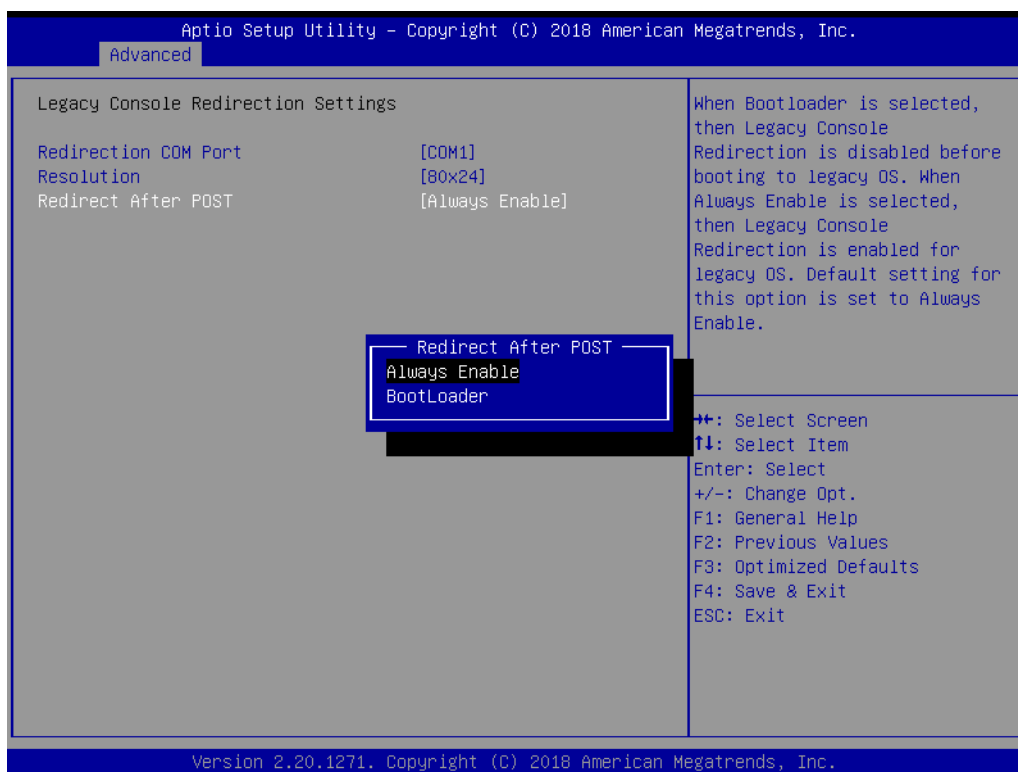
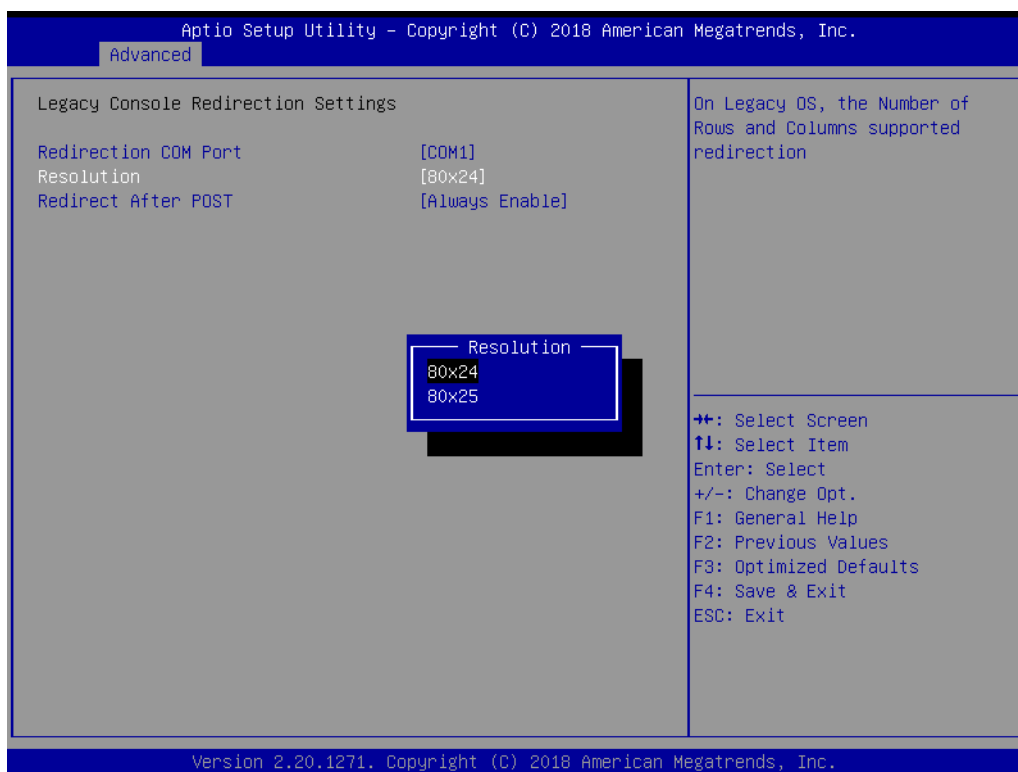

- **Redirection to COM Port**
This item allows users to set the COM port for displaying redirected legacy OS and legacy OPRM messages.
- **Resolution**
This item allows users to set the number of rows and columns that support redirection on legacy OS.
- **Redirect After POST**
This item allows users to Enable/Disable redirection after POST. When

“Bootloader” is selected, legacy console redirection is Disabled before booting to legacy OS. When “Always Enable” is selected, legacy console redirection is Enabled for legacy OS.

3.3.12 Intel® Trusted Execution Technology (TXT) Information

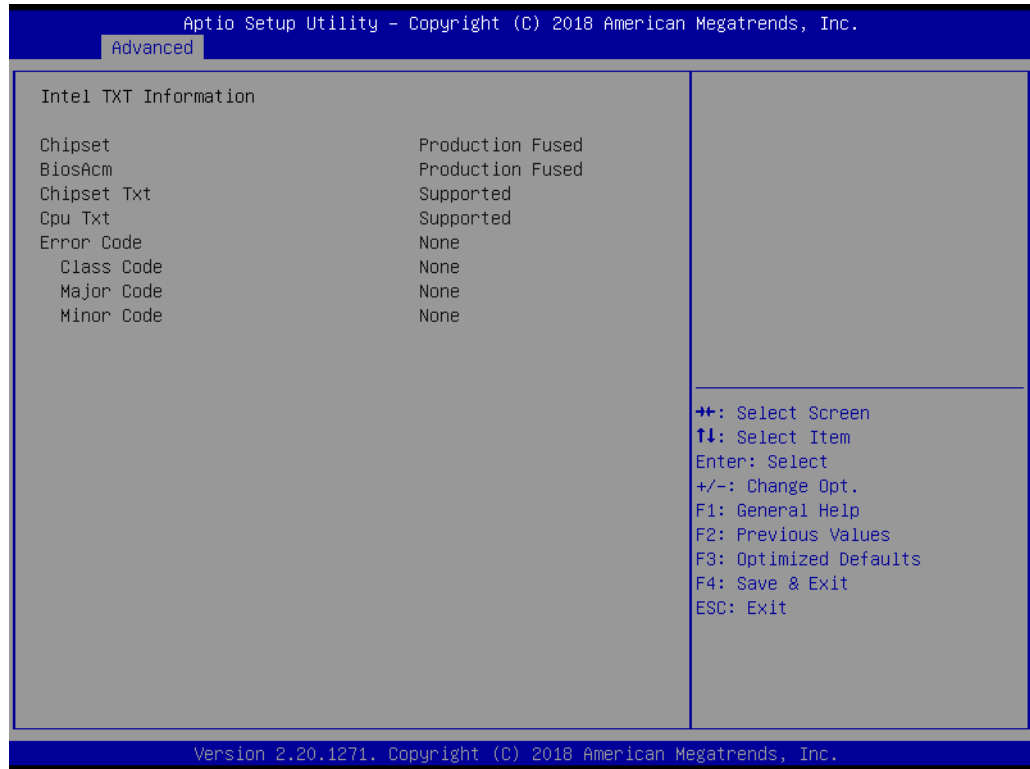

Figure 3.15 Intel® TXT Information Screen

3.3.13 PCI Subsystem Settings

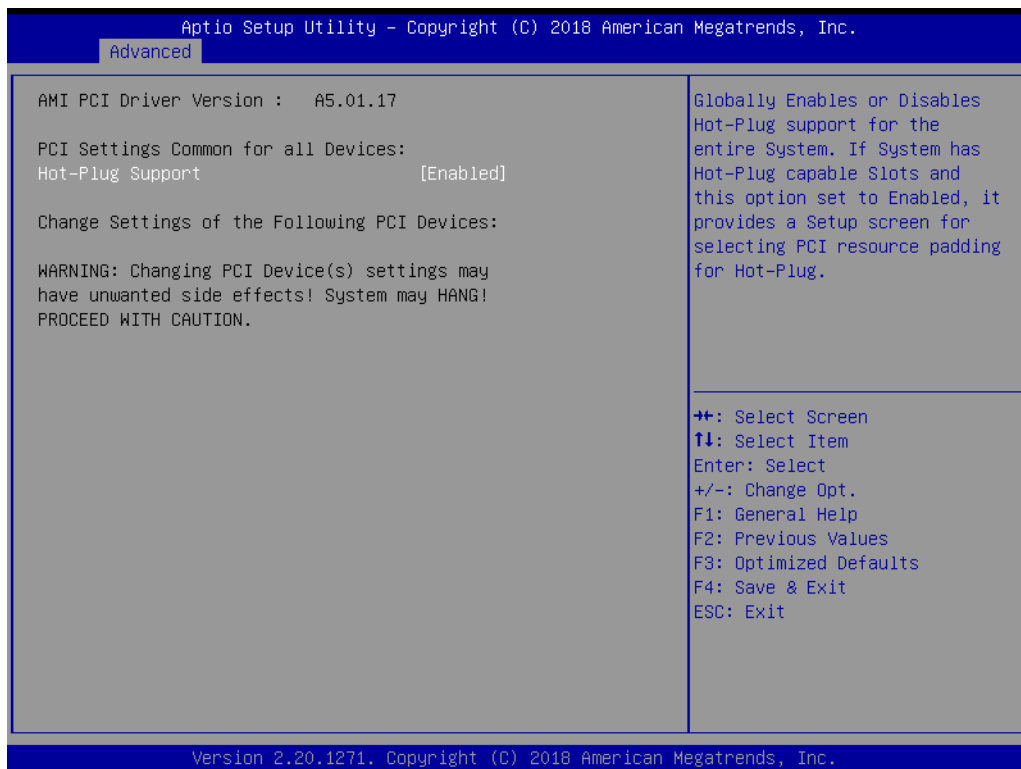

Figure 3.16 PCI Subsystem Settings Screen

- **Hot-Plugging Support**

This item allows users to Enable/Disable hot-plugging slot functionality. When this item is Enabled, a setup screen is displayed for selecting the PCI resource padding for hot-plugging.

Note! *Altering the PCI device settings may cause unwanted side effects. Specifically, the system may hang.*



3.3.14 USB Configuration

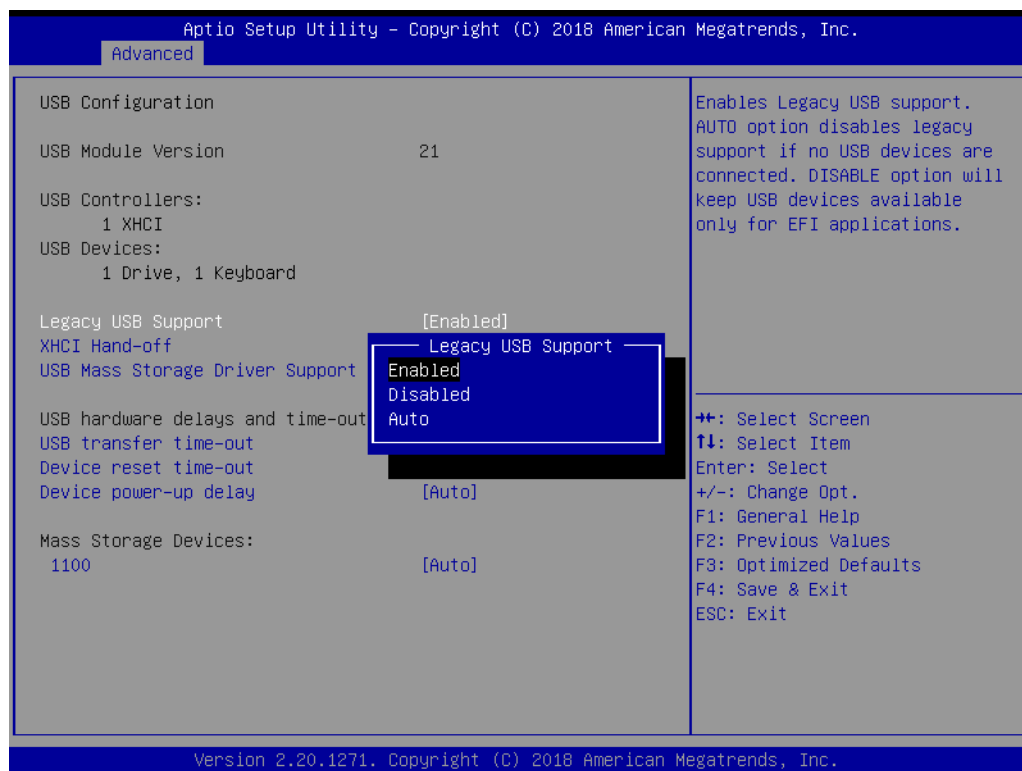
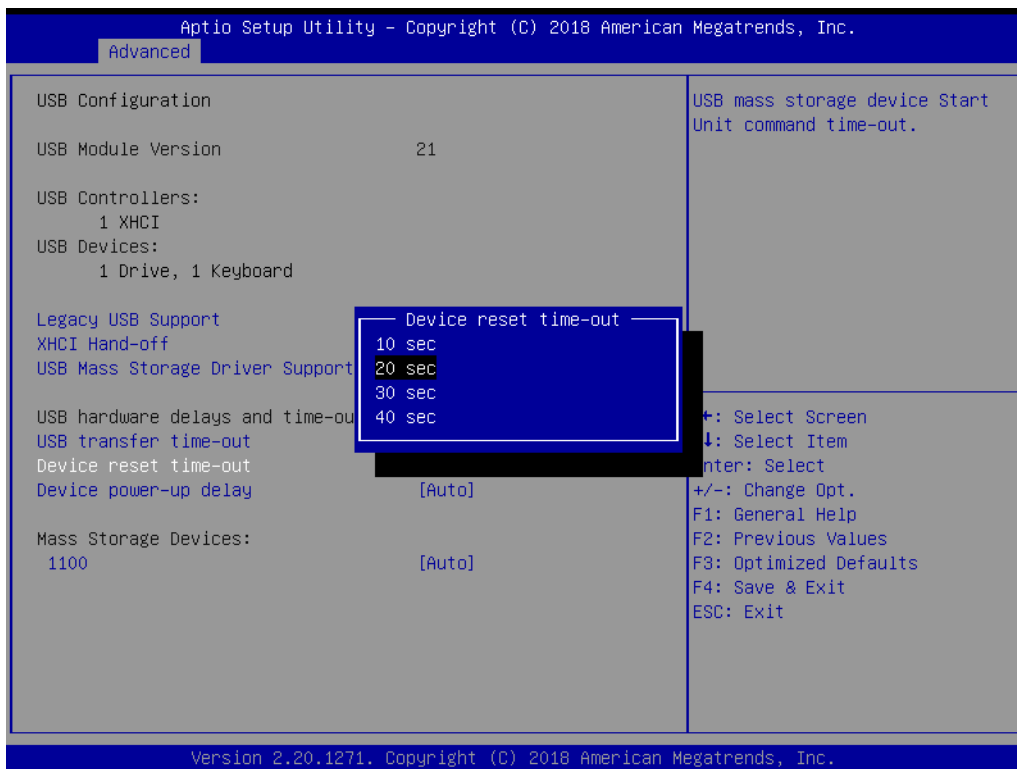
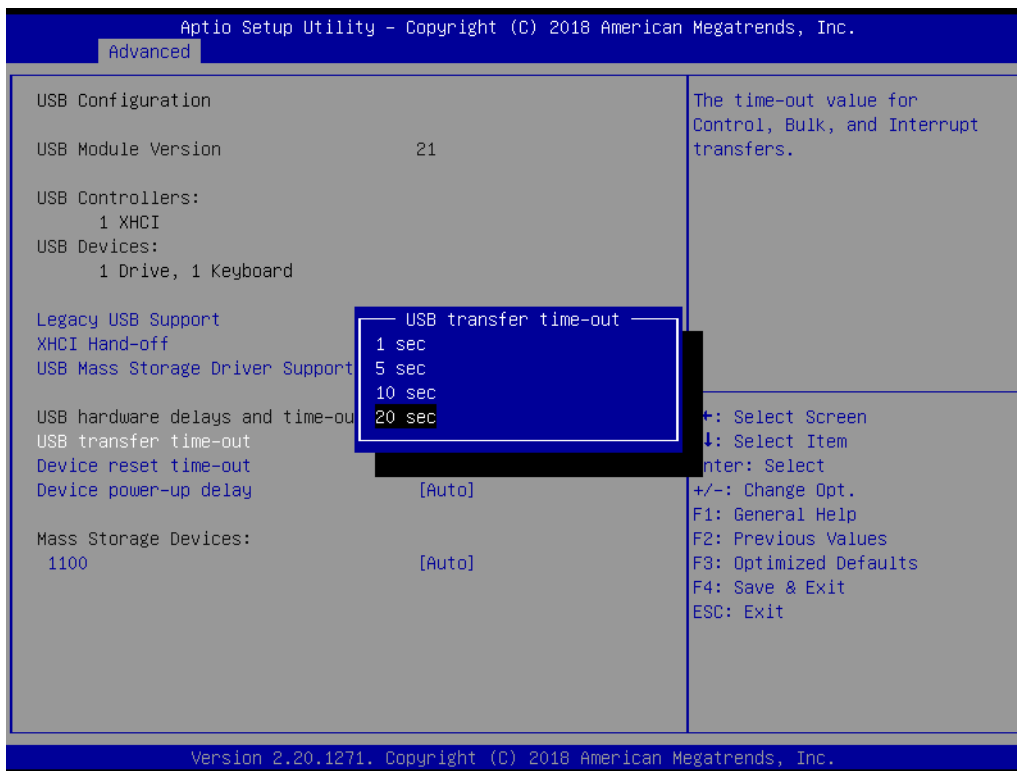
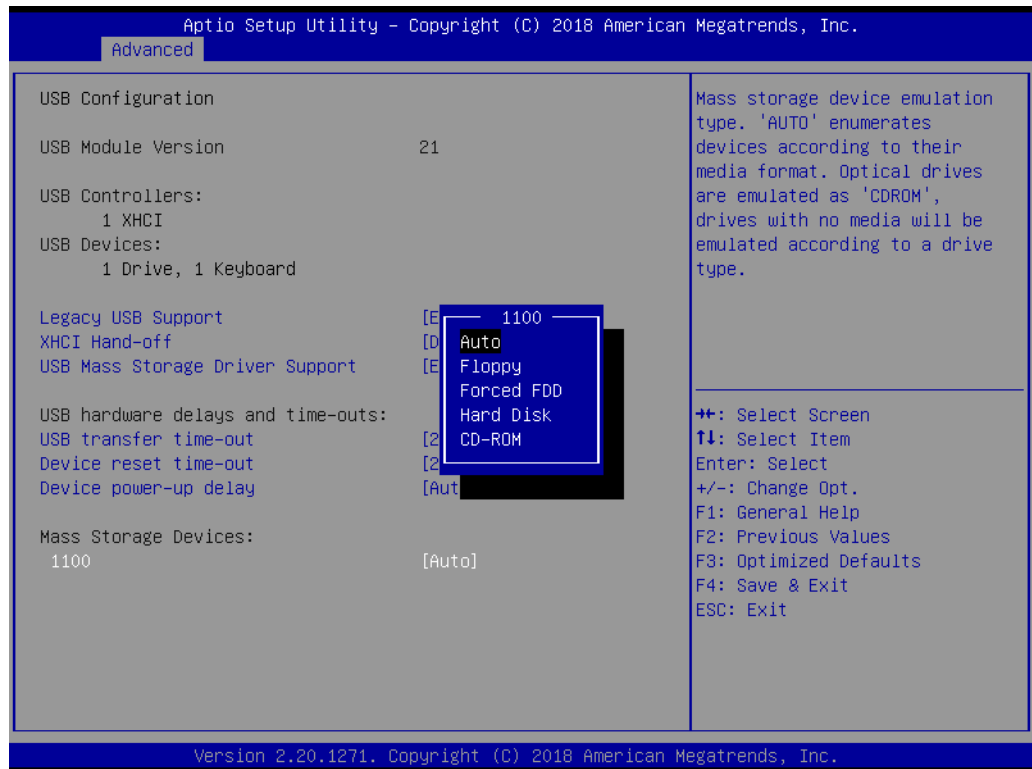
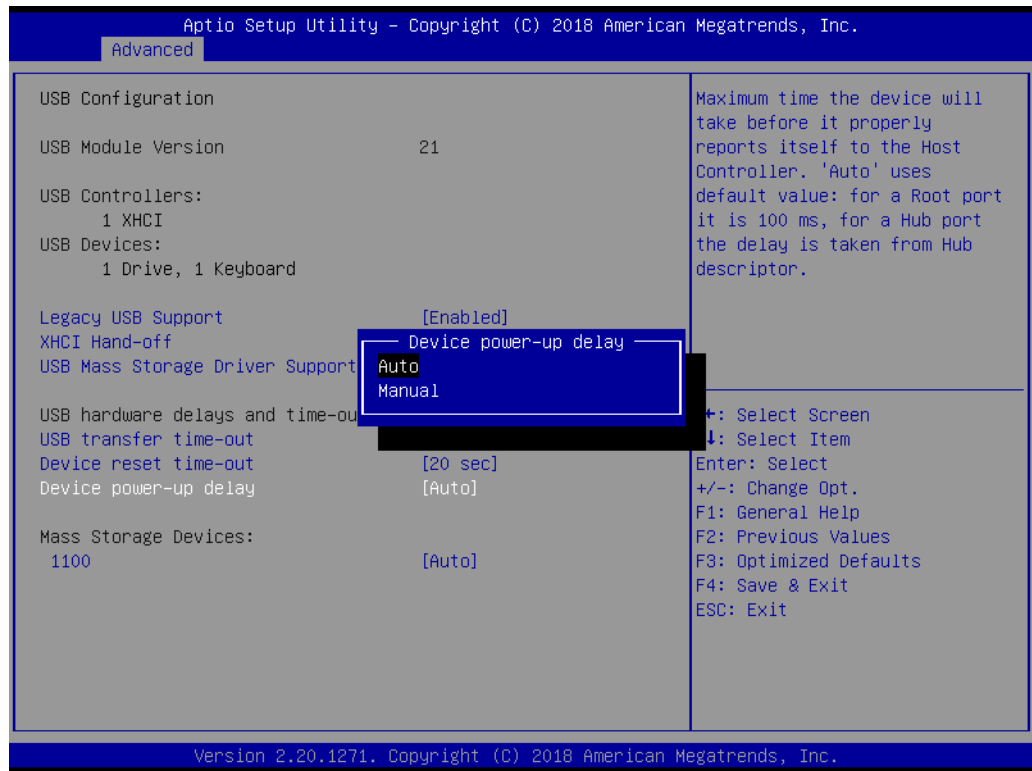

Figure 3.17 USB Configuration Screen

- **Legacy USB Support**
This item allows users to Enable/Disable legacy USB support. The Auto option disables legacy support if no USB devices are connected. When Disabled, USB devices will be reserved for EFI applications. This option is only available after the BIOS is set to Legacy from the default UEFI mode.
- **XHCI Hand-Off**
This item provides a workaround for OS without XHCI hand-off support. The XHCI ownership change should be claimed by the XHCI driver.
- **USB Mass Storage Driver Support**
This item allows users to Enable/Disable USB mass storage driver support.
- **USB Transfer Timeout**
This item allows users to set the timeout value for Control, Bulk, and Interrupt transfers.
- **Device Reset Timeout**
This item allows users to set the USB mass storage device start unit command timeout value.
- **Device Power-Up Delay**
This item allows users to set the maximum time the device will take before reporting to the host controller. The Auto option uses the default value, which is 100 ms for a root port; for a Hub port, the delay time is determined via the hub descriptor.
- **Mass Storage Devices**
This item allows users to configure the mass storage device emulation type. The Auto emulates devices according to their media format. Optical drives are emulated as CDROM and drives with no media are emulated according to the drive type.





3.3.15 UEFI Network Stack Configuration



Figure 3.18 UEFI Network Stack Configuration Screen

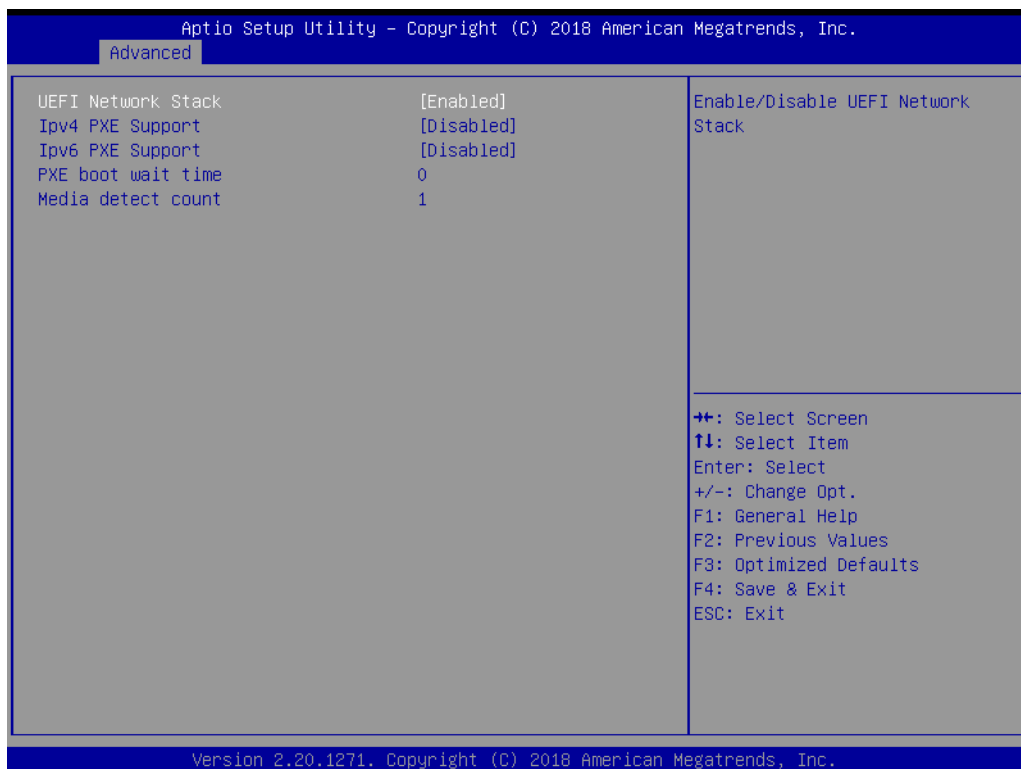

- **UEFI Network Stack**
This item allows users to Enable/Disable the UEFI network stack.
- **IPv4/IPv6 PXE Support**
This item allows users to Enable/Disable IPv4/IPv6 PXE boot support.

- **PXE Boot Wait Time**
This item allows users to specify the wait time in seconds for pressing the <ESC> key to abort PXE bootup.
- **Media Detect Count**
This item allows users to specify the number of times the system will search for media.

3.3.16 CSM Configuration

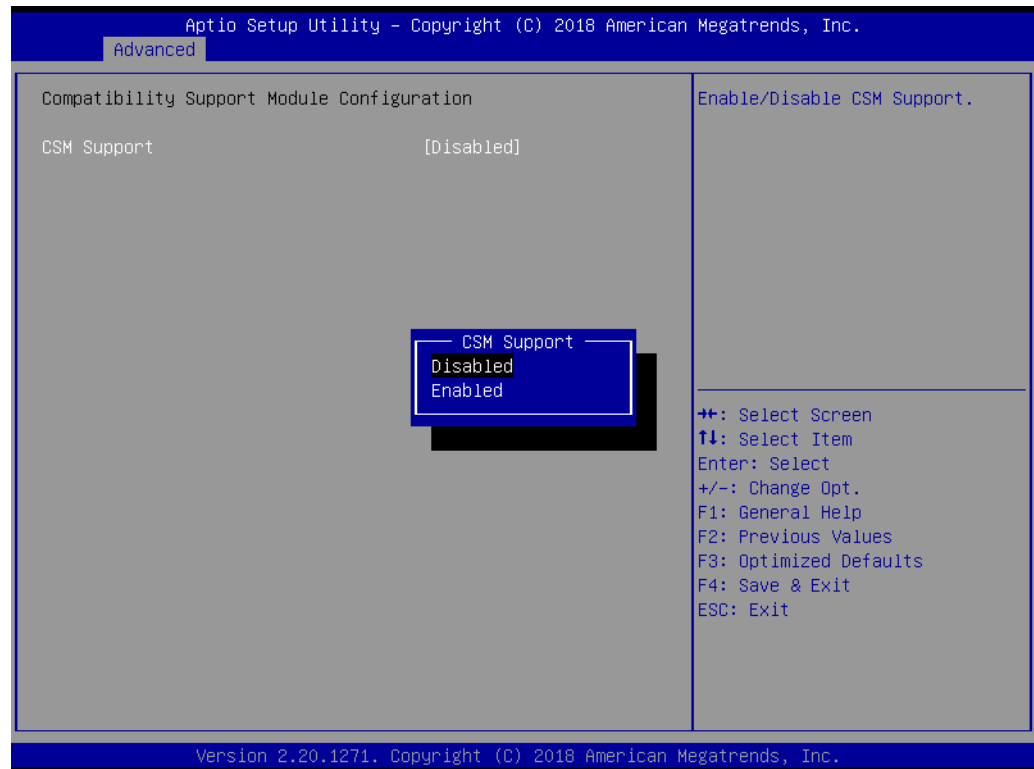
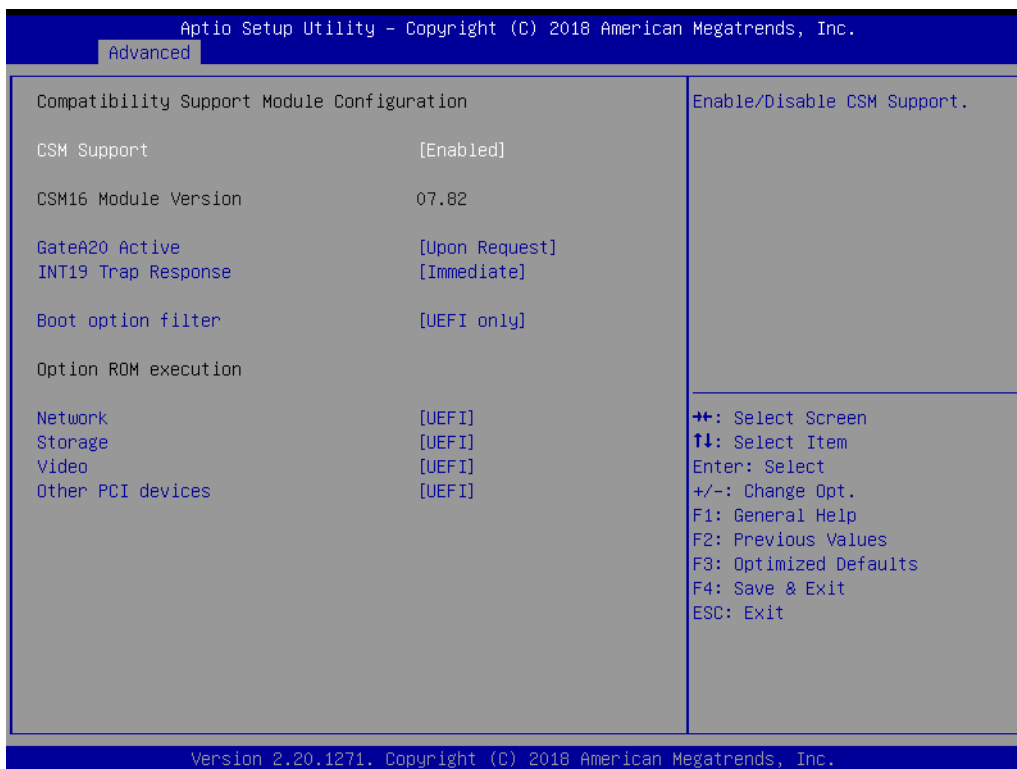
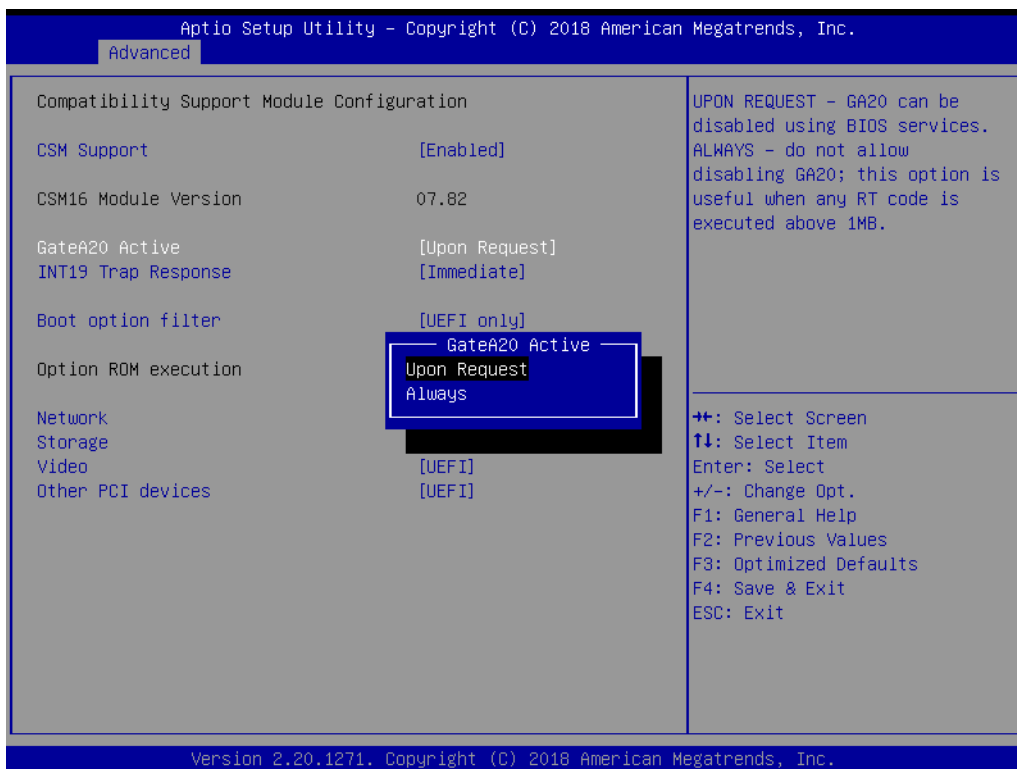

Figure 3.19 CSM Configuration Screen



- **CSM Support**
This item allows users to Enable/Disable CSM support. When set as Disabled, the system can only support UEFI mode.
- **GateA20 Active**
This item allows users to configure the GA20 settings when RT code is executed above 1 MB. When set as “Upon Request”, GA20 can be disabled via the BIOS. When set as “Always”, GA20 disabling is not allowed.



■ **INT19 Trap Response**

This item allows users to configure the BIOS reaction to INT19 trapping by Option ROM execution. When set as “Immediate”, the trap is executed right away. When set as “Postponed”, the trap is executed during legacy boot.

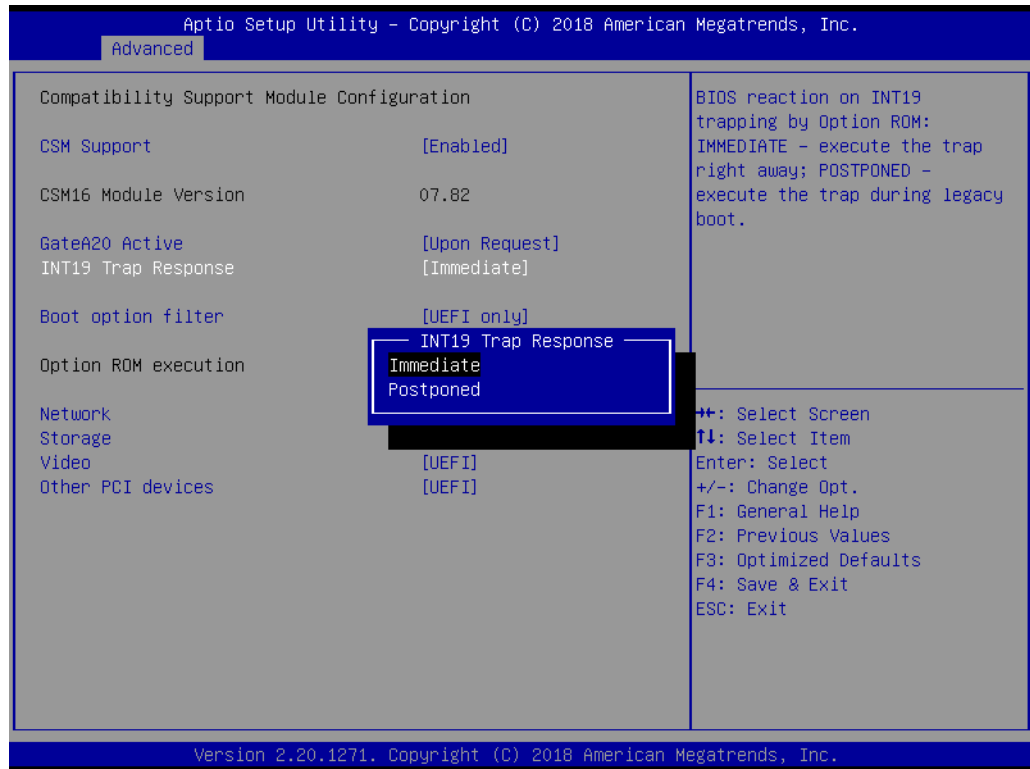

■ **Boot Option Filter**

This item allows users to set the priority for legacy/UEFI ROMs.

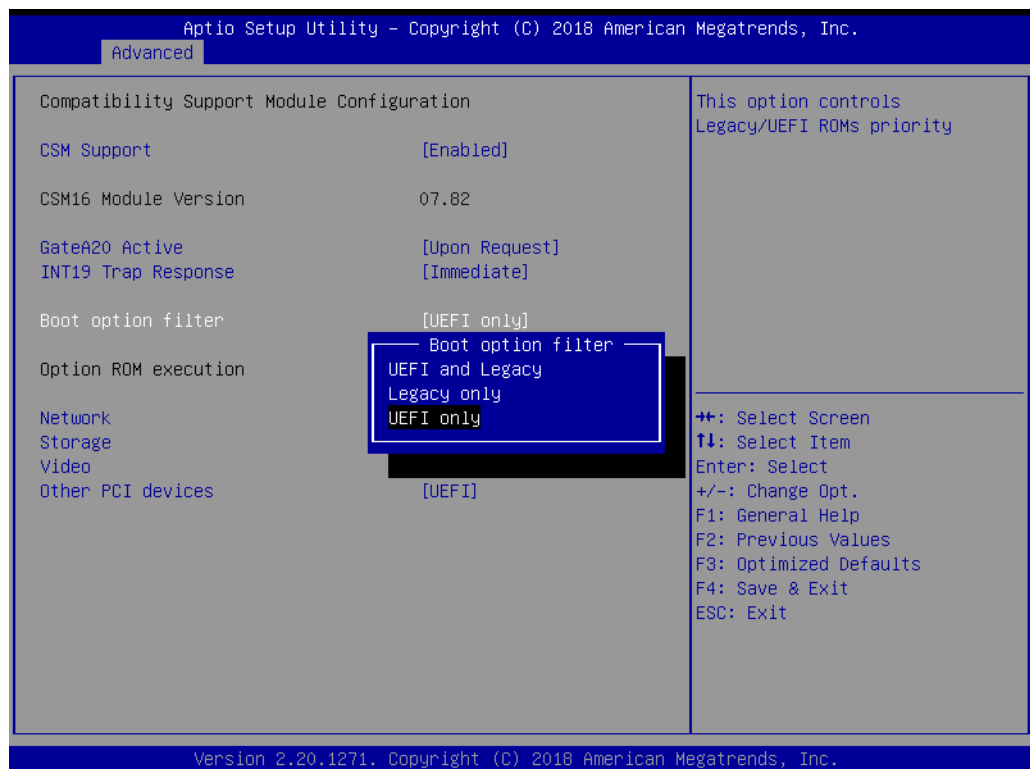

- **Option ROM Execution**

- **Network**

This item allows users to control the execution of UEFI and the legacy PXE Option ROM.

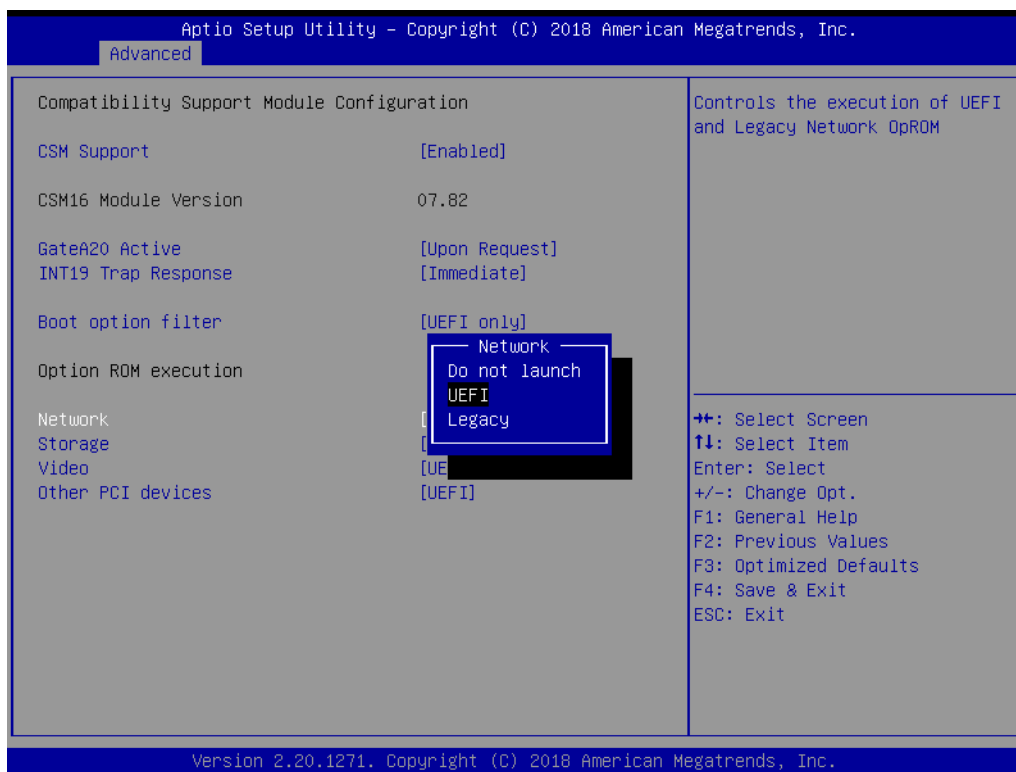

- **Storage**

This item allows users to control the execution of UEFI and the legacy storage Option ROM.

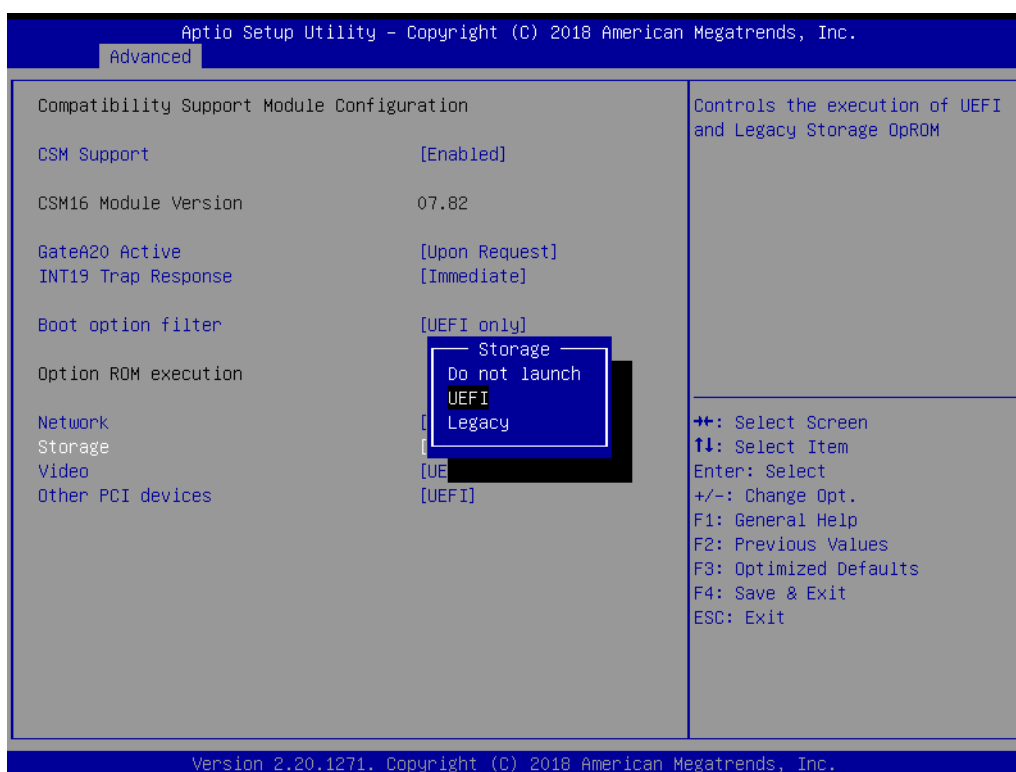

■ **Video**

This item allows users to control the execution of UEFI and the legacy video Option ROM.

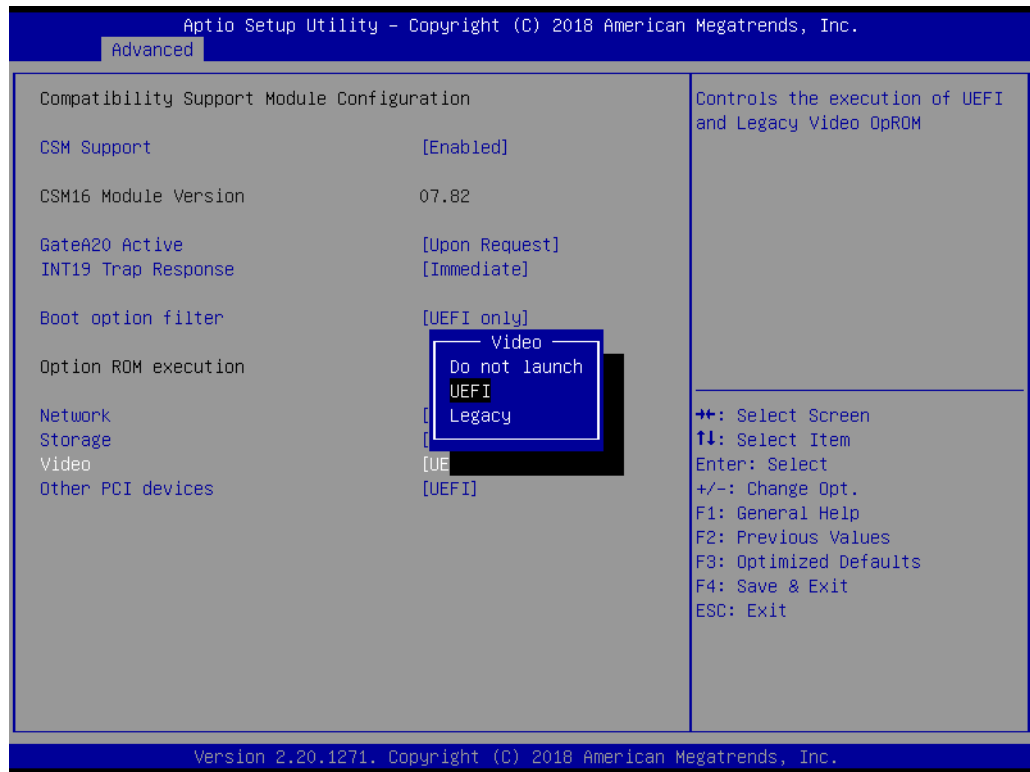

■ **Other PCI Devices**

This item allows users to control the execution of the Option ROM policy for devices other than network, storage, or video.

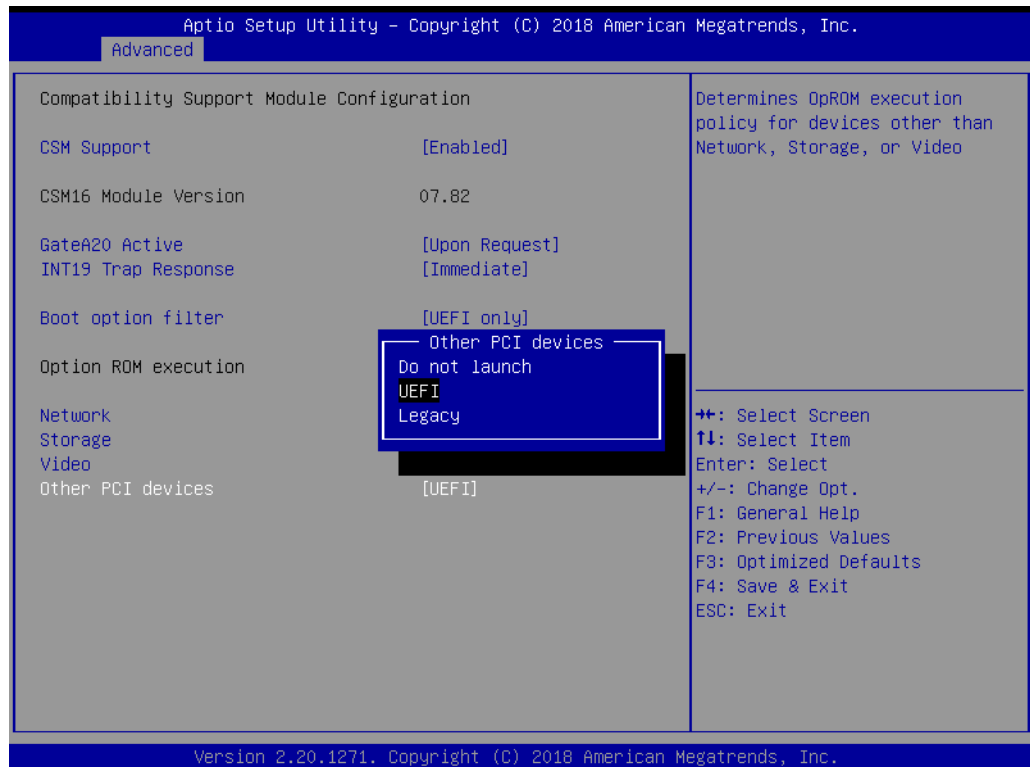

3.4 Chipset

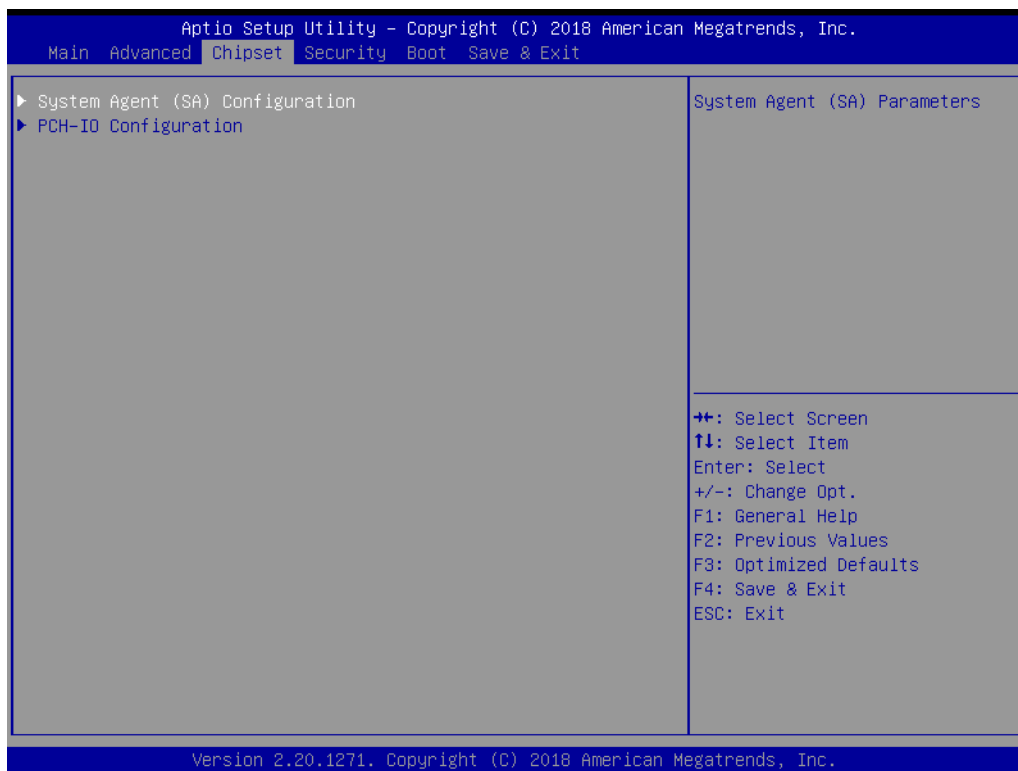

Figure 3.20 Chipset Configuration Screen

3.4.1 System Agent (SA) Configuration

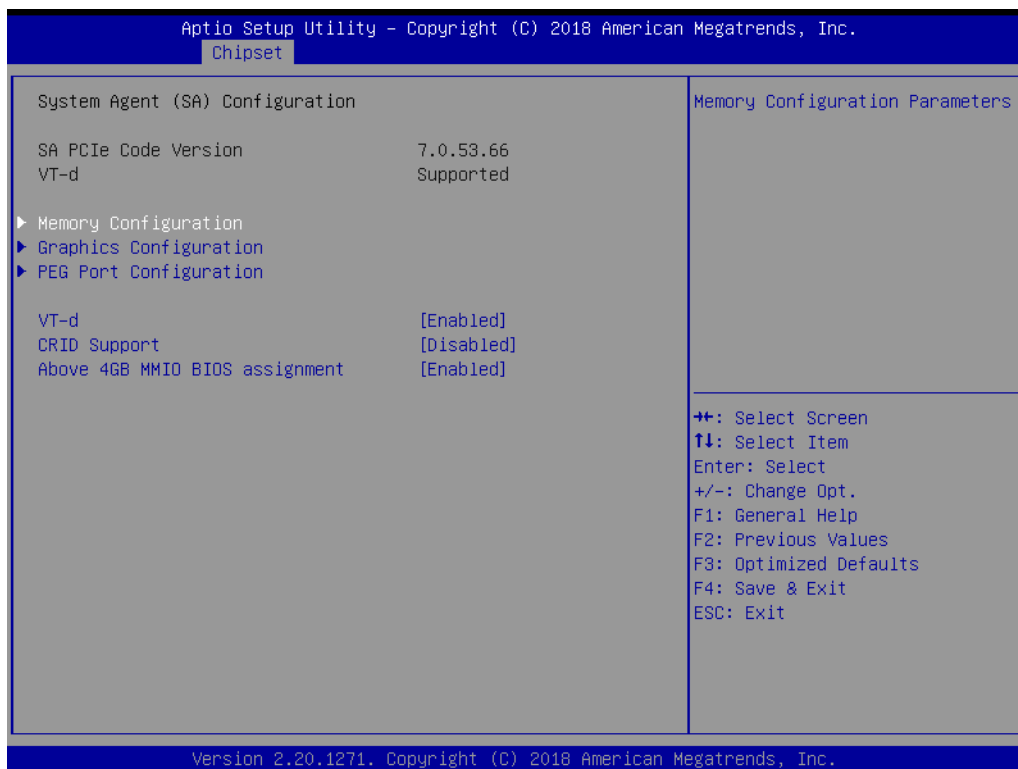
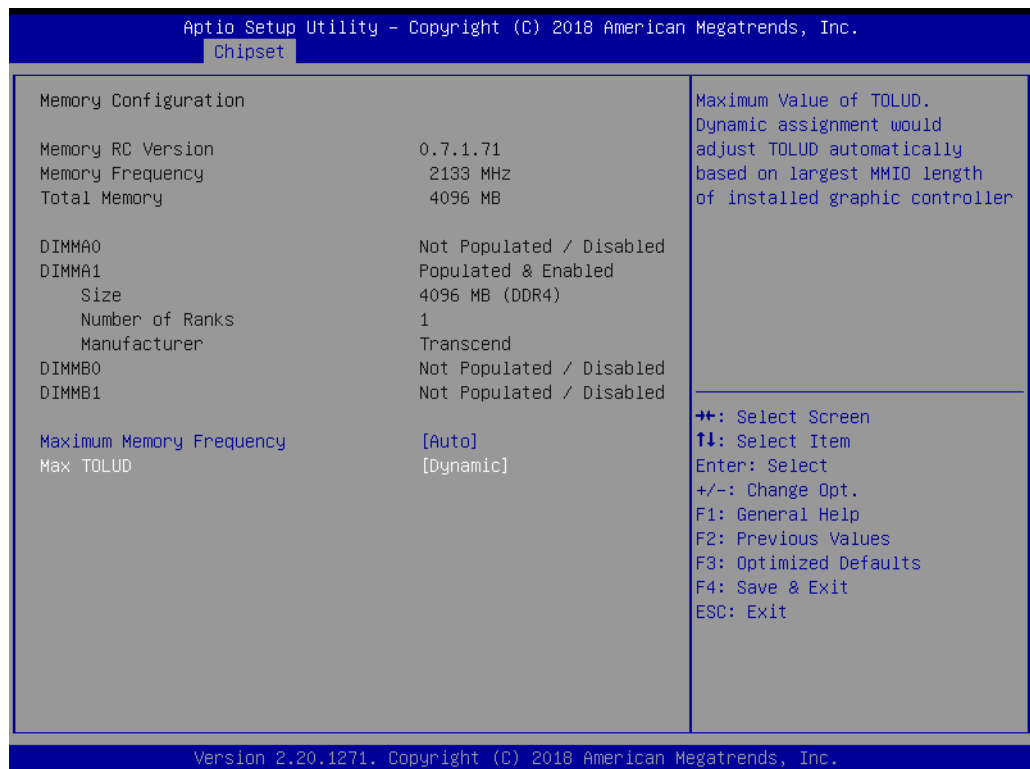

Figure 3.21 SA Configuration Screen

- **VT-d**
This item allows users to Enable/Disable VT-d function on the memory controller hub (MCH).
- **CRID Support**
This item allows users to Enable/Disable CRID control for the Intel® Stable Image Platform Program (SIPP).
- **Above 4G MMIO BIOS Assignment**
This item allows users to Enable/Disable the automatic BIOS assignment of above 4 GB memory-mapped I/O. This function is disabled automatically when the aperture size is set to 2048 MB.

3.4.1.1 Memory Configuration



- **Max TOLUD**
This item allows users to set the maximum TOLUD value. When the Dynamic assignment option is elected, TOLUD is automatically adjusted according to the largest MMIO length of the installed add-on cards.

3.4.1.2 Graphics Configuration

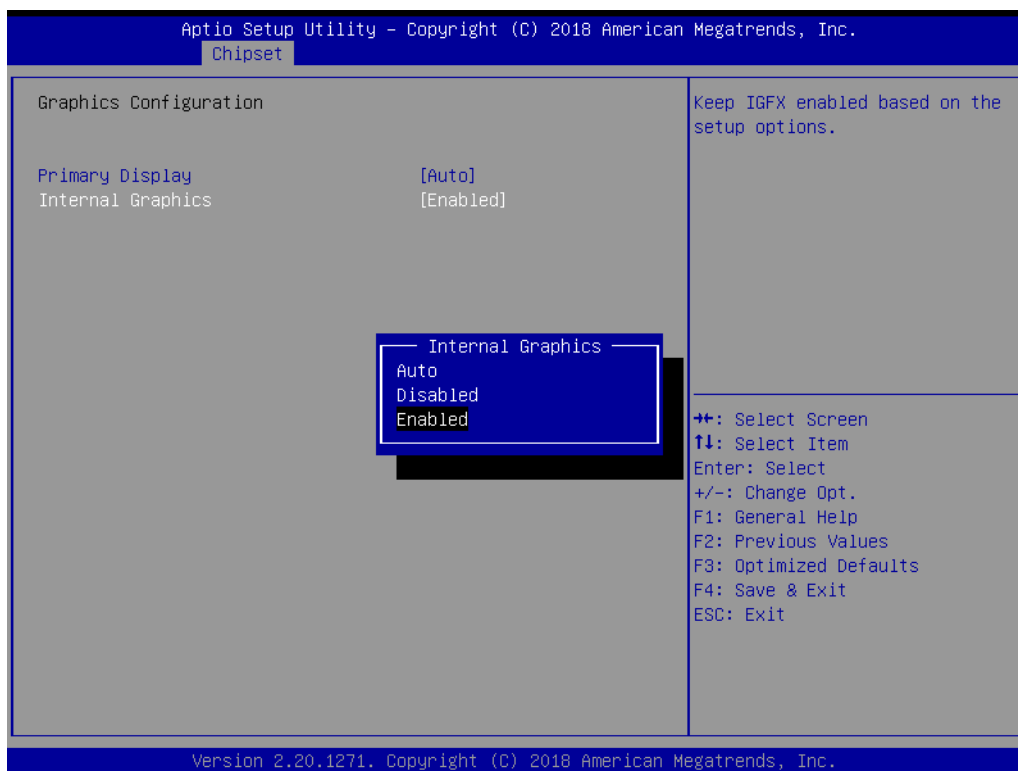
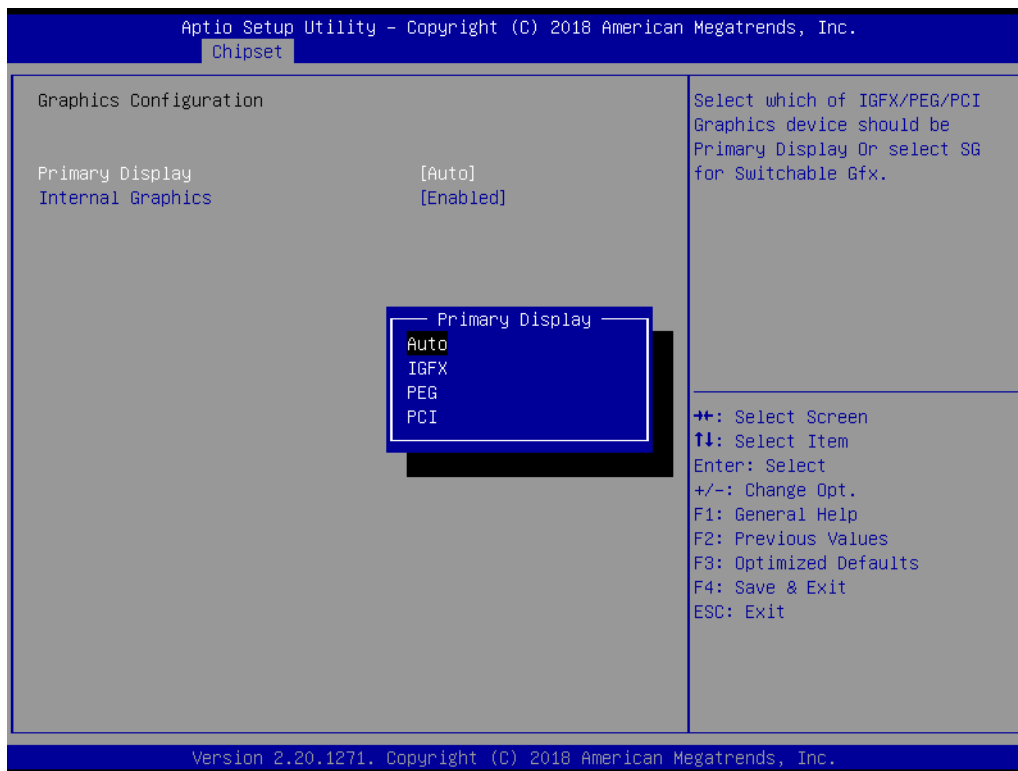

- Primary Display**
 This item allows users to configure the primary display settings. Options include Auto, IGFX, PEG, and PCI Graphics.

Note! *When “Auto” is selected, the display priority is add-on cards > BMC VGA (with cable) > onboard VGA. For G4 SKU, BMC VGA can be set as primary by changing the “Auto” default setting to “PCI”.*



■ **Internal Graphics**

This item allows users keep IGFX enabled based on the setup options.

3.4.1.3 PEG Port Configuration

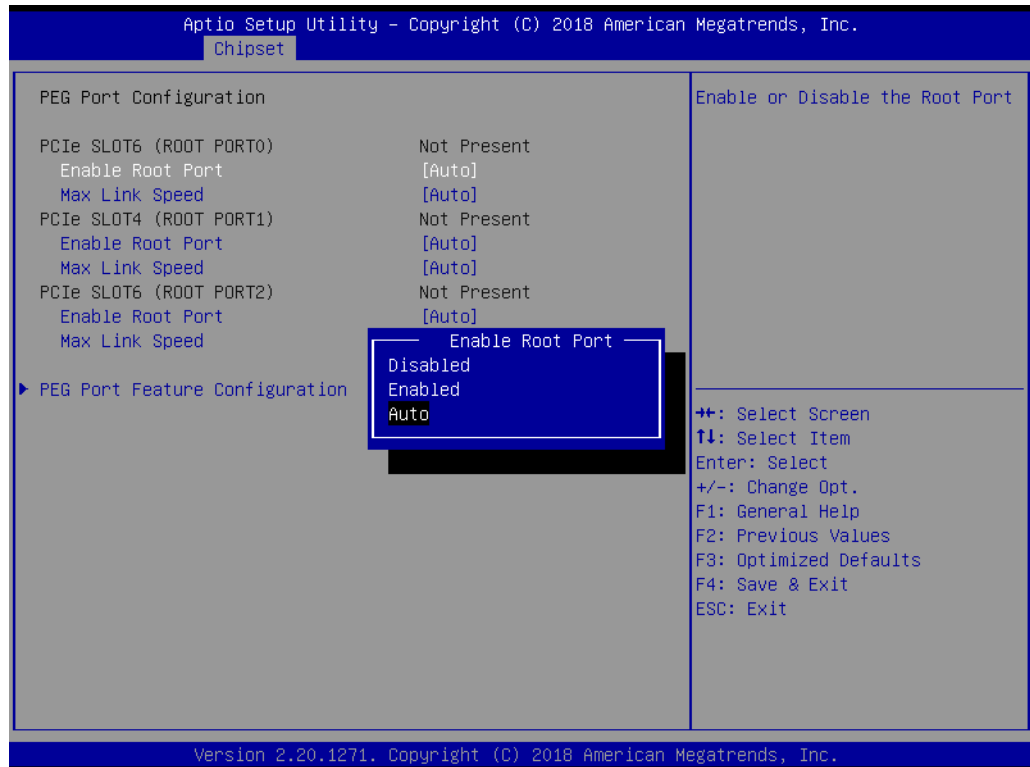

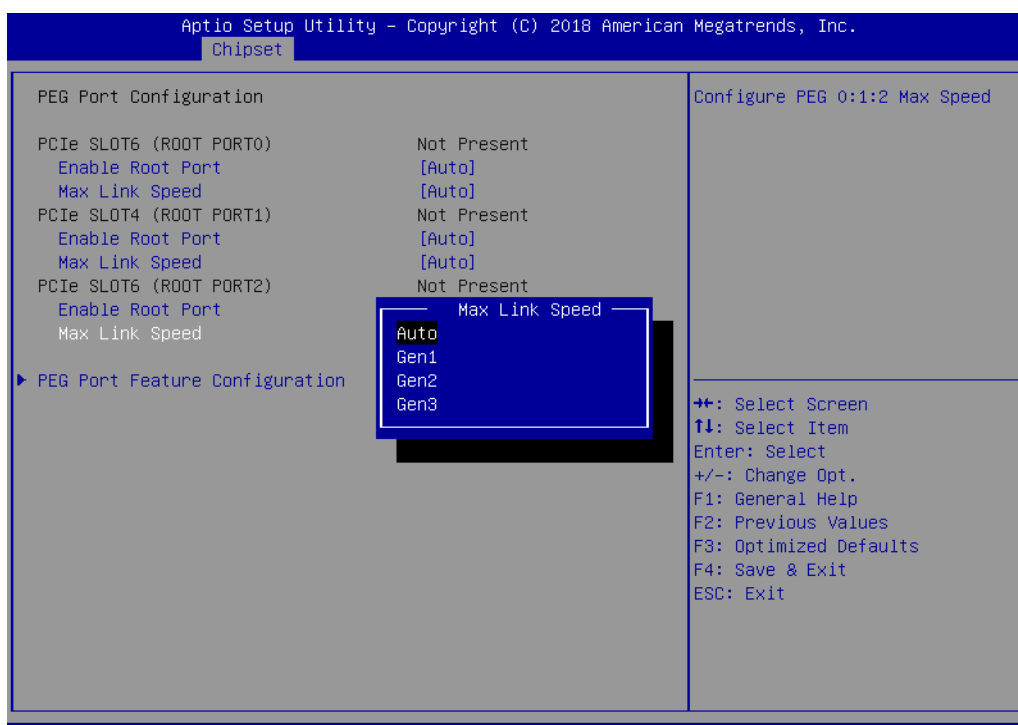

- **PCIe SLOT6 (ROOT PORT0)**
This item allows users to Enable/Disable Root Port0 and configure the PEG 0:1:0 max. link speed.
- **PCIe SLOT4 (ROOT PORT1)**
This item allows users to Enable/Disable Root Port1 and configure the PEG 0:1:1 max.
- **PCIe SLOT6 (ROOT PORT2)**
This item allows users to Enable/Disable Root Port2 and configure the PEG 0:1:2 max. link speed.
- **PEG Port Feature Configuration**
This item allows users to Enable/Disable the detection of non-compliant PCI Express devices in PEG.

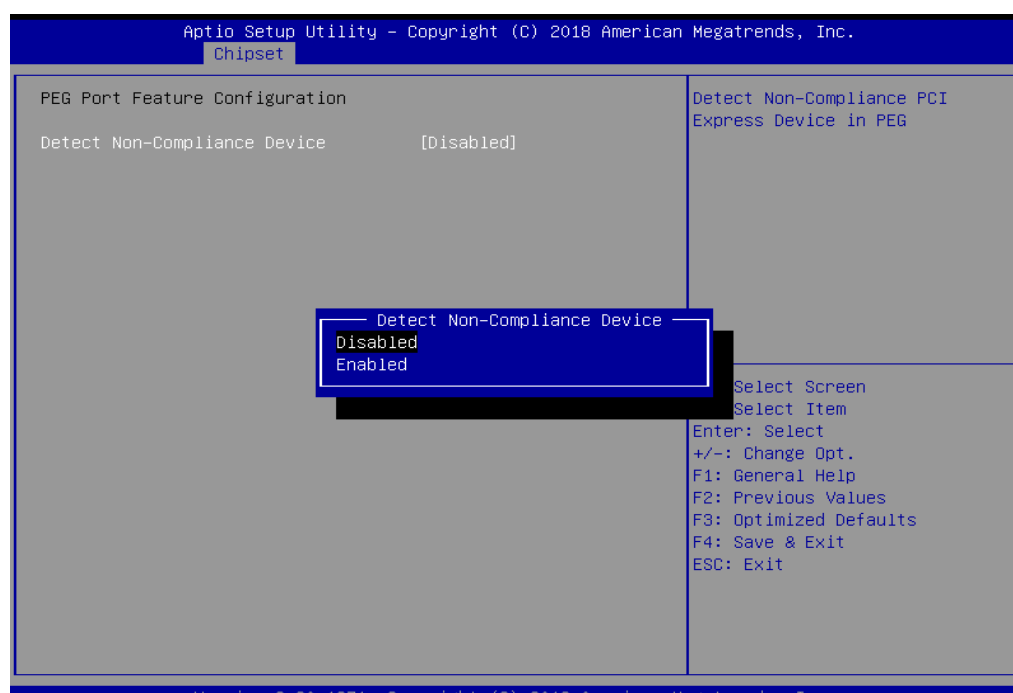

3.4.2 PCH-IO Configuration

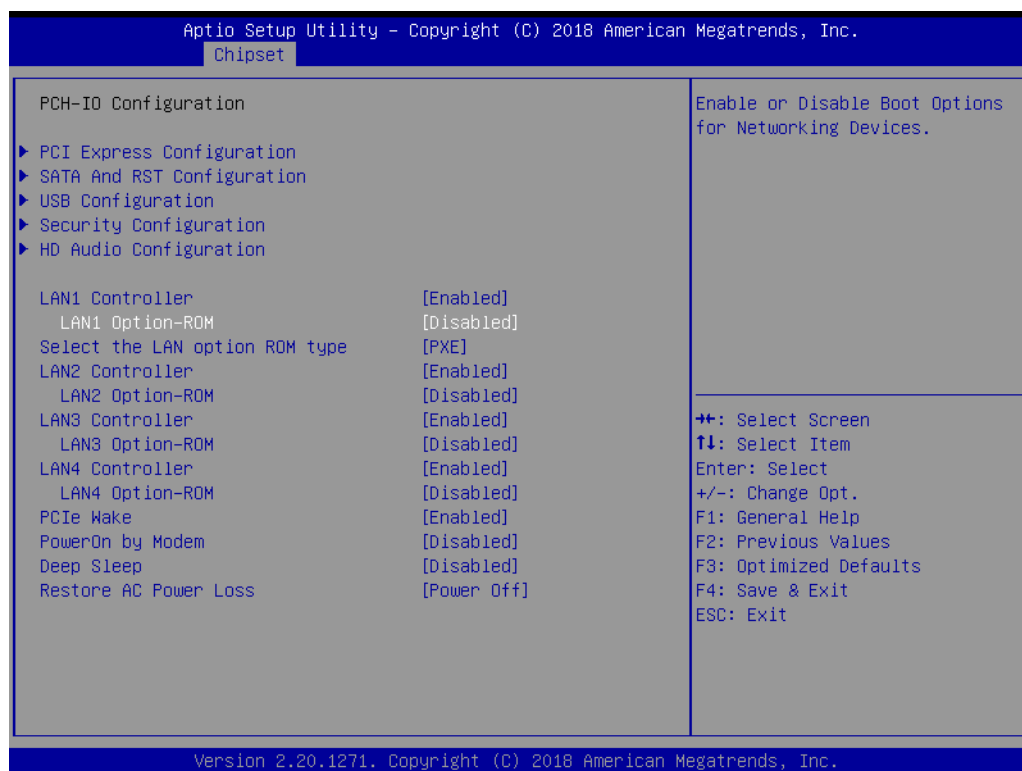



Figure 3.22 PCH-IO Configuration Screen

- **LAN1 Controller**
This item allows users to Enable/Disable the onboard NIC.
- **LAN1 Option ROM**
This item allows users to Enable/Disable boot options for the LAN1 controller.
- **Select the LAN Option ROM Type**
This item allows users to select PXE or iSCSI for i210 (LAN2, LAN3, LAN4).
- **LAN2 Controller**
This item allows users to Enable/Disable the onboard LAN2.
- **LAN2 Option ROM**
This item allows users to Enable/Disable boot options for the LAN2 controller.
- **LAN3 Controller**
This item allows users to Enable/Disable the onboard LAN3.
- **LAN3 Option ROM**
This item allows users to Enable/Disable boot options for the LAN3 controller.
- **LAN4 Controller**
This item allows users to Enable/Disable the onboard LAN4.
- **LAN4 Option ROM**
This item allows users to Enable/Disable boot options for the LAN4 controller.
- **PCIE Wake**
This item allows users to Enable/Disable “PCIE Wake From S5” functionality.
- **PowerOn by Modem**
This item allows users to Enable/Disable “PowerOn by Modem” functionality.
- **Deep Sleep**
This item allows users to Enable/Disable Deep Sleep support.

■ Restore AC Power Loss

This item allows users to set the preferred state for when power is restored after a power failure (G3 state).

Note!  When a system enters G3 status with deep S5 enabled, for some power supplies, 5VSB will not decline for at least 30 seconds. When set as Power On, the system will not boot up for 30 seconds after a power failure. We recommend users wait for more than 30 seconds to power the system back on after a power failure.

However, the system will automatically power back on if the power supply is restored within 30 seconds, before the 5VSB drops, even when configured as Power Off.

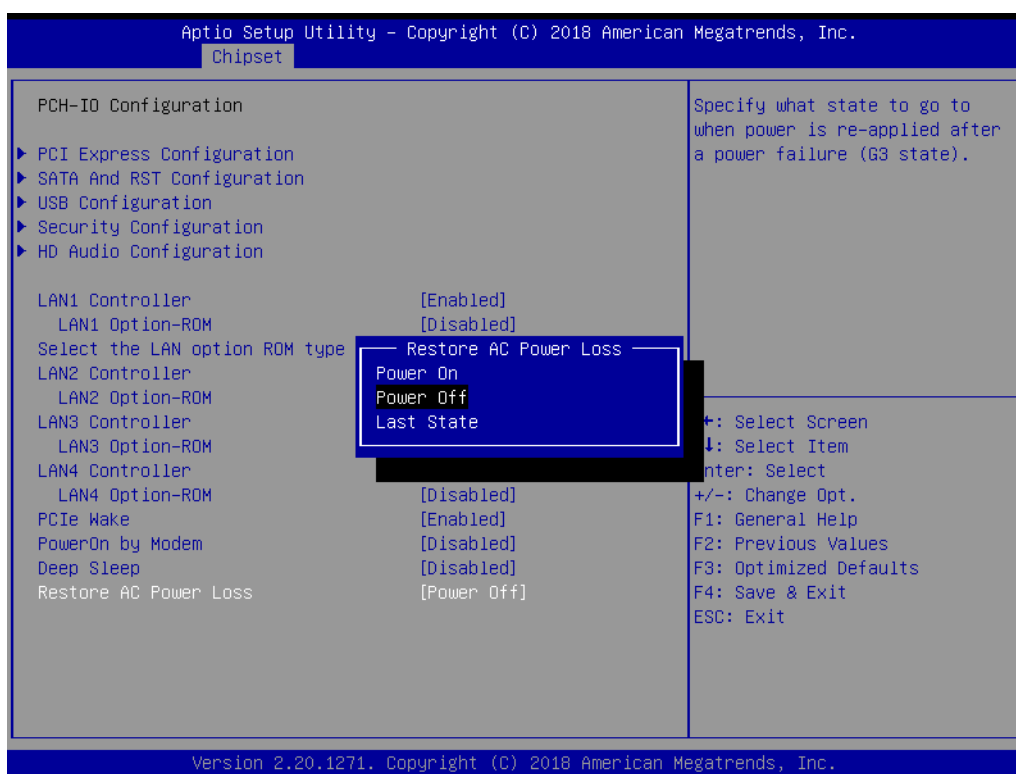

3.4.2.1 PCI Express Configuration

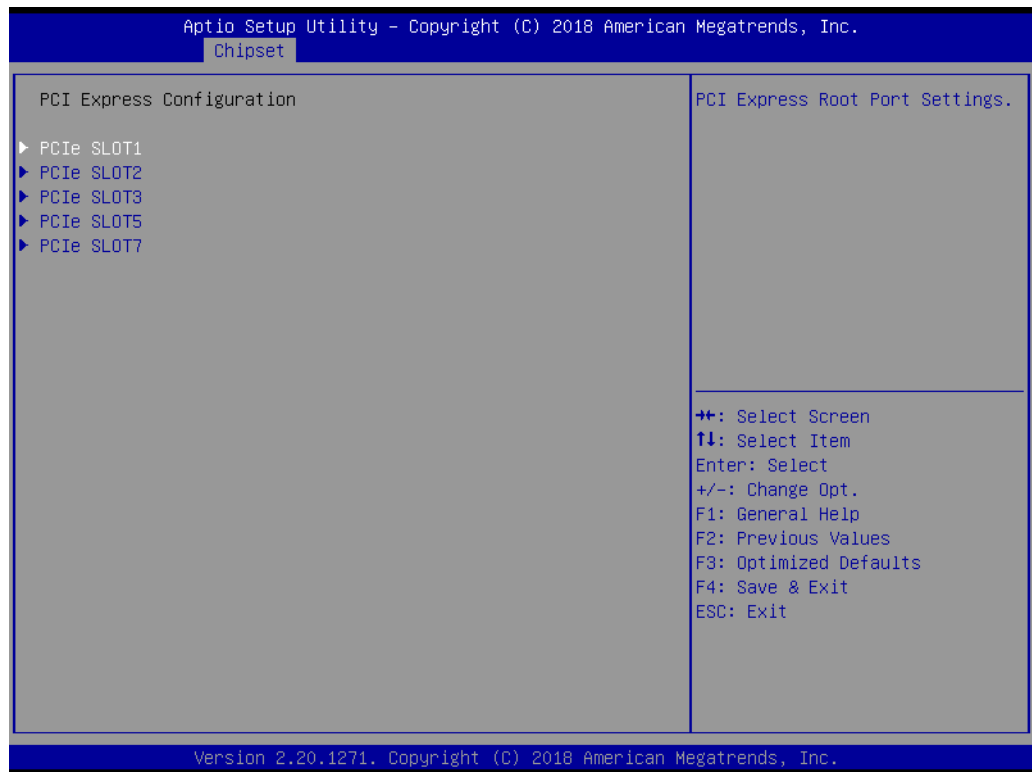
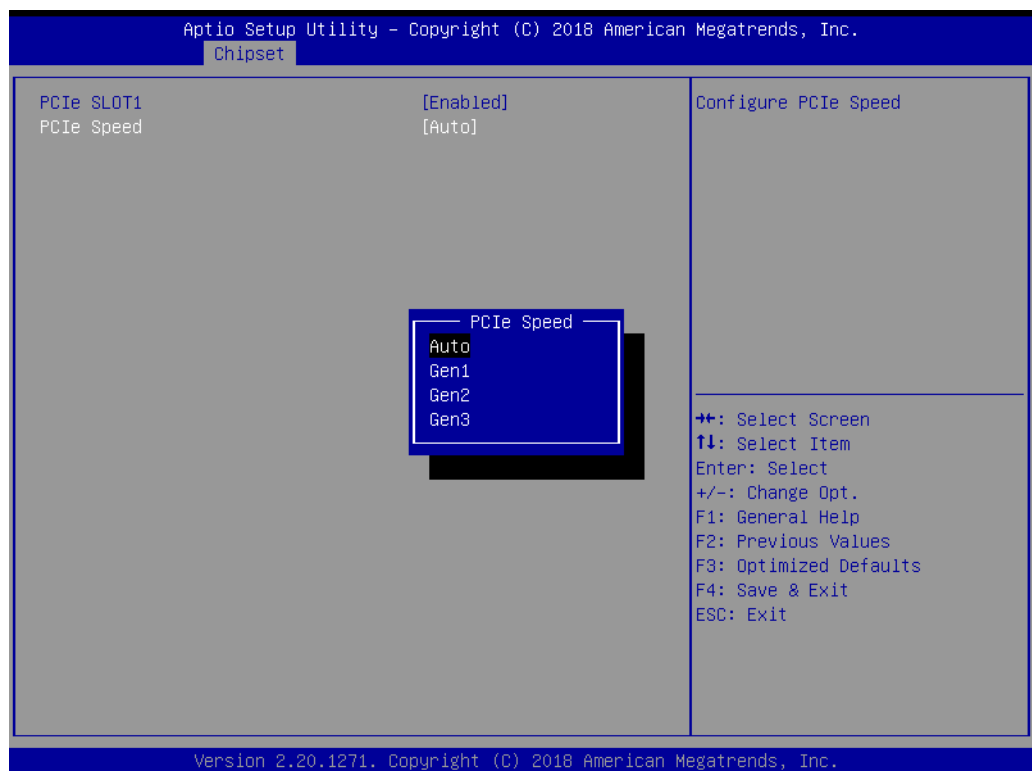

Figure 3.23 PCI Express Configuration Screen



- **PCIe Slot 1/2/3/5/7**
This item allows users to control the PCI Express root port.
- **PCIe Speed**
This item allows users to set the PCIe speed for PCIe slots 1, 2, 3, 5, and 7.

3.4.2.2 SATA And RST Configuration

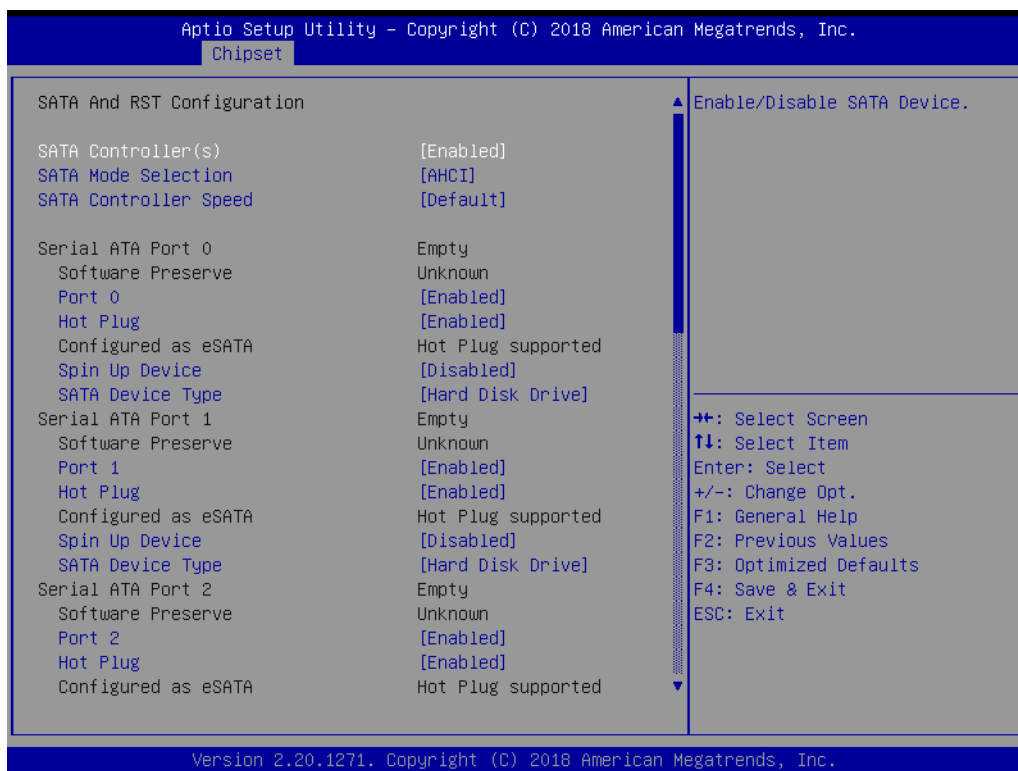

Figure 3.24 SATA and RST Configuration Screen

- **SATA Controller(s)**
This item allows users to Enable/Disable SATA controllers.
- **SATA Mode Selection**
This item allows users to set the SATA mode as AHCI or RAID when SATA controllers are Enabled.
- **SATA Controller Speed**
This item allows users to set the maximum SATA controller speed.
- **Port 0~7**
This item allows users to Enable/Disable SATA ports 0~7.
- **Hot-Plugging**
This item allows users to Enable/Disable hot-plugging port functionality.
- **Spin Up Device**
This item allows users to Enable/Disable device spinup. If Enabled for any port, staggered spinup at boot is performed for drives with this option enabled. If this item is configured as Disabled, all drives will spinup at boot.
- **SATA Device Type**
This item allows users to determine whether the SATA port is connected to a SSD or HDD.

3.4.2.3 USB Configuration

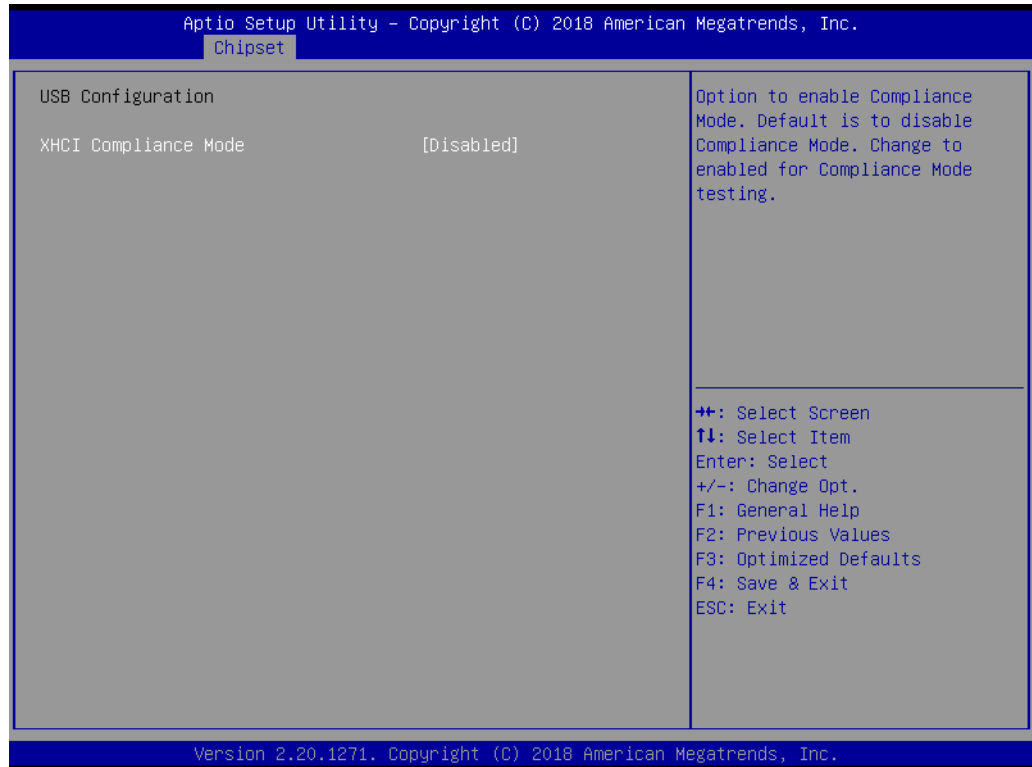

Figure 3.25 USB Configuration Screen

- **XHCI Disable Compliance Mode**
This item allows users to Enable/Disable compliance mode. The default setting is Disabled. However, for compliance mode testing, this item must be Enabled.

3.4.2.4 Security Configuration



Figure 3.26 Security Configuration Screen

- **RTC Memory Lock**
This item allows users to Enable/Disable RTC memory locking. When Enabled, bytes 38h-3Fh in the lower/upper 128-byte bank of RTC RAM will be locked.
- **BIOS Lock**
This item allows users to Enable/Disable PCH BIOS locking. This item must be Enabled to ensure flash protection in SMM.
- **Force Unlock on All GPIO Pads**
This item allows users to Enable/Disable forced unlocking of all GPIO pads. When Enabled, the BIOS will force all GPIO pads to the unlocked state.

3.4.2.5 HD Audio Configuration

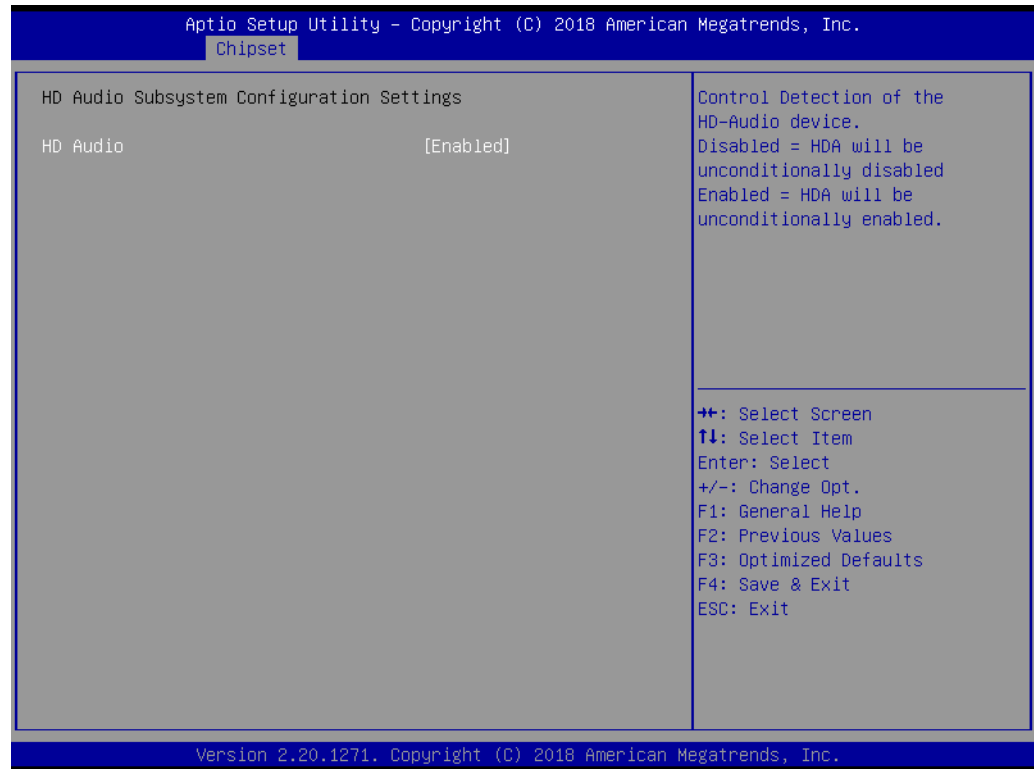

Figure 3.27 HD Audio Configuration Screen

- **HD Audio**
This item allows users to control the detection of HD audio devices.

3.5 Security

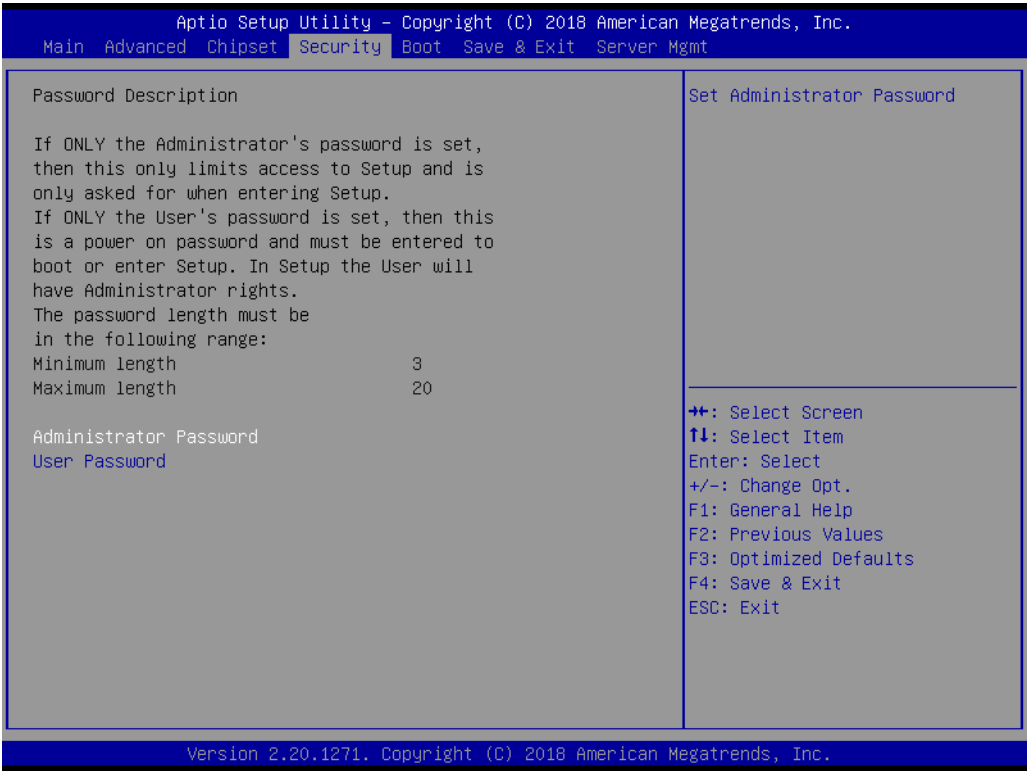

Figure 3.28 Security Configuration Screen

Select the Security tab from the main BIOS Setup menu. All Security menu items, such as password protection, are described in this section. To access the sub menu of any item, navigate to the item using the <Arrow> keys and press <Enter>.

3.6 Boot

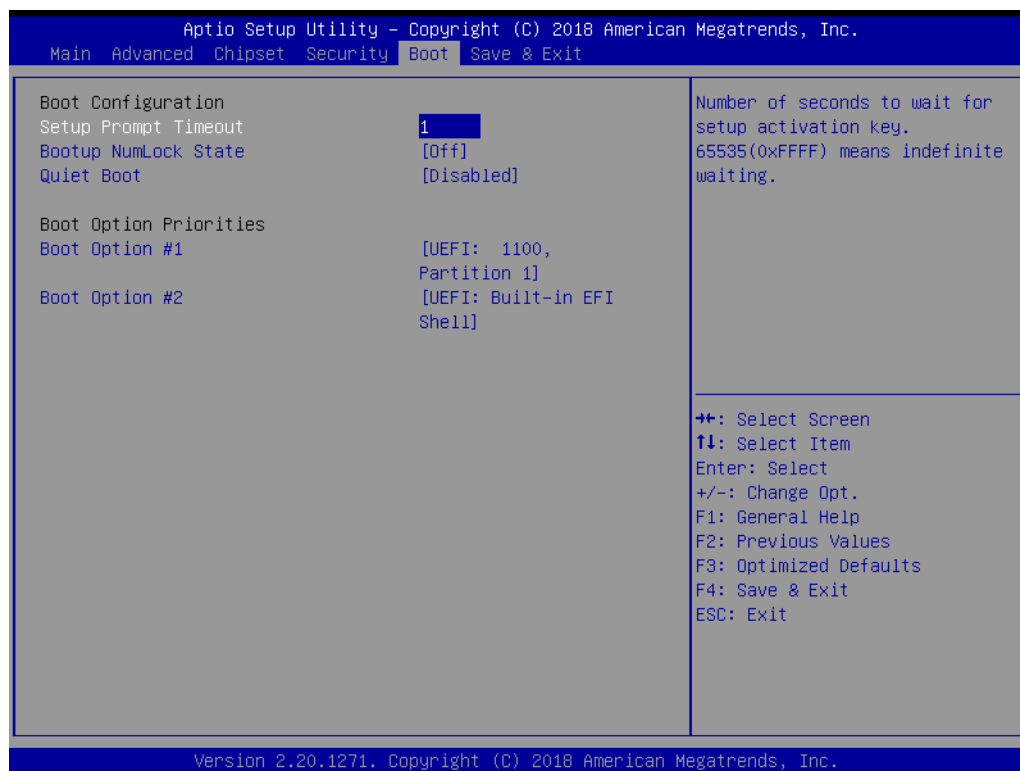

Figure 3.29 Boot Configuration Screen

- **Setup Prompt Timeout**
This item allows users to set the setup prompt timeout time in seconds. Use the <+> and <-> keys to adjust the number of seconds the system will wait for a setup activation key.
- **Bootup NumLock State**
This item allows users to Enable/Disable the NumLock state at system bootup.
- **Quiet Boot**
This item allows users to Enable/Disable quiet bootup. If set as Disabled, the BIOS displays normal POST messages. If Enabled, an OEM Logo is displayed instead of POST messages.
- **Boot Option Priorities**
This item allows users to set the boot priority for devices.

Note! *UEFI devices can be recognized as a default. Enable device recognition in the CSM Configuration settings to support legacy devices when needed.*



3.7 Save and Exit

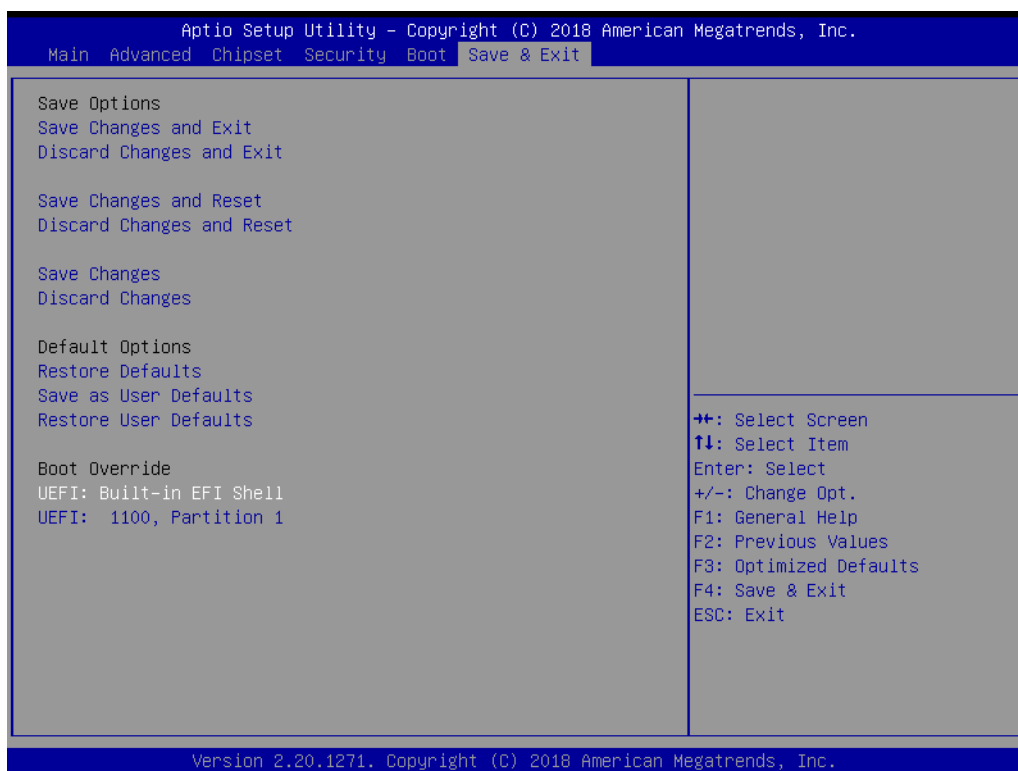

Figure 3.30 Save and Exit Screen

- **Save Changes and Exit**
 This item allows users to save all configuration changes and exit the BIOS Setup utility. After exiting, proceed with the OS bootup to allow the new system configuration settings to take effect. If critical changes have been made, the entire system will reboot automatically.
- **Discard Changes and Exit**
 This item allows users to exit the BIOS Setup utility without making any permanent changes to the system configuration.
- **Save Changes and Reset**
 This item allows users to save all configuration changes, exit the BIOS Setup utility, and reboot the system.
- **Discard Changes and Reset**
 This item allows users to exit the BIOS Setup utility and reboot the system without making any permanent changes to the system configuration.
- **Save Changes**
 This item allows users to save all changes to the system configuration.
- **Discard Changes**
 This item allows users to discard all changes to the system configuration.
- **Restore Defaults**
 This item allows users to restore all BIOS configuration settings to the original defaults.
- **Save as User Defaults**
 This item allows users to save all configuration settings as a user default.

- **Restore User Defaults**
This item allows users to restore all BIOS configuration settings to a specific user's default settings.
- **UEFI: Built-In EFI Shell**
This item allows users to launch the EFI Shell application (shellx64.efi) from one of the available file system devices.

3.8 Server Management

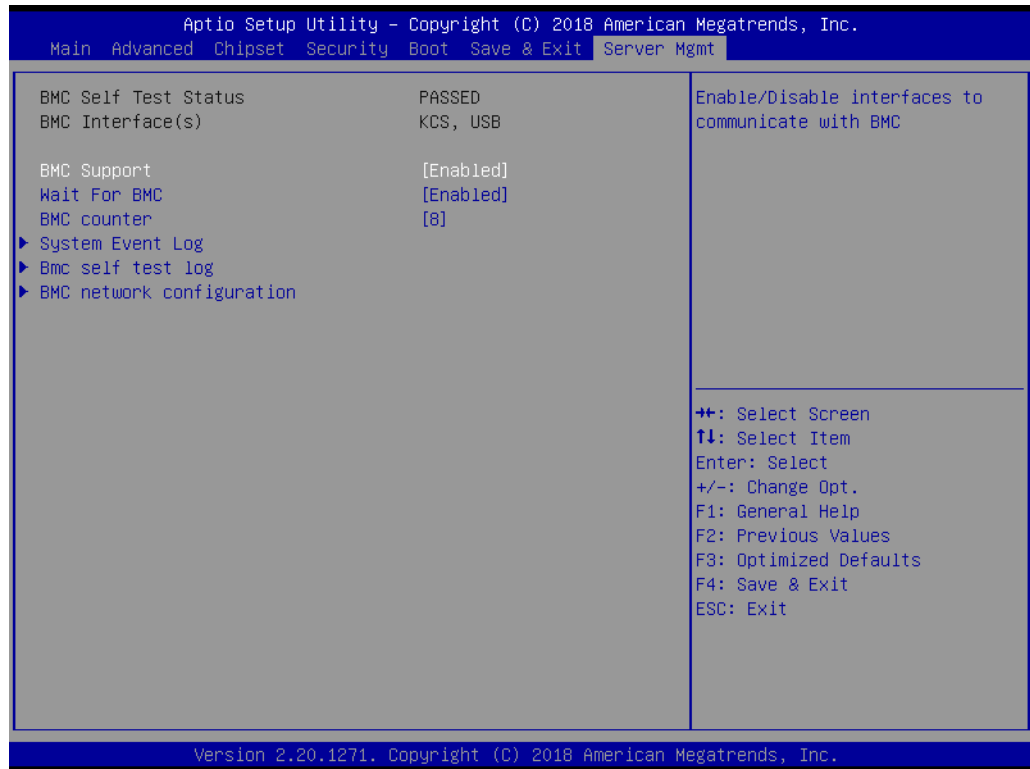
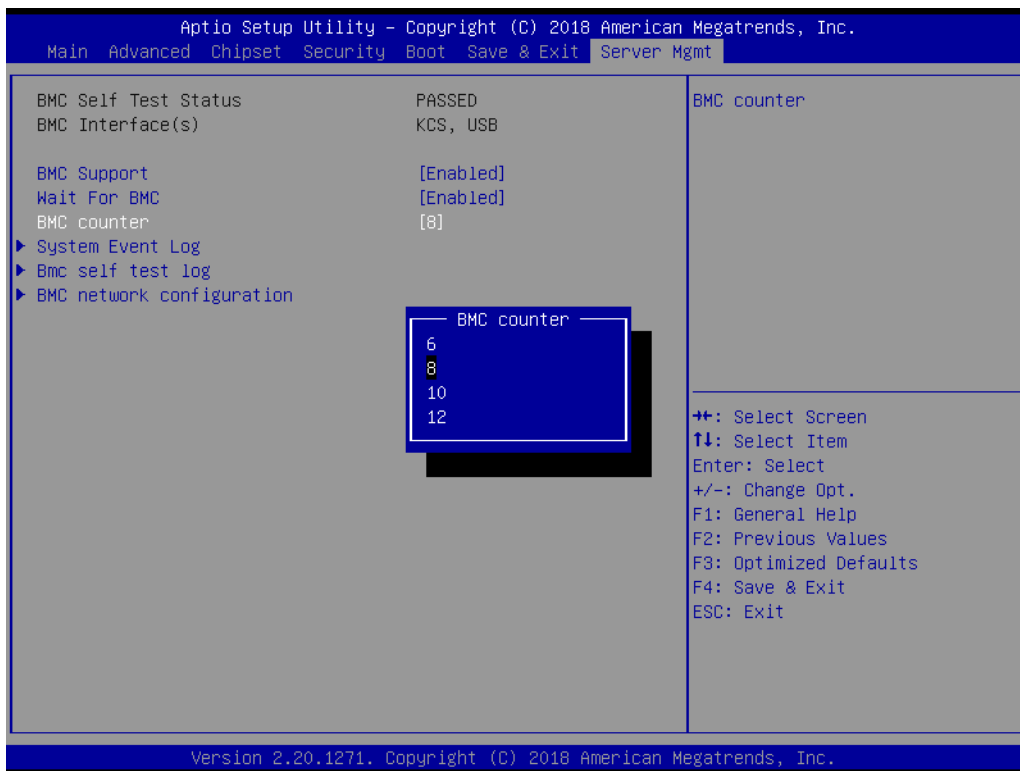

Figure 3.31 Server Management Screen

- **BMC Support**
This item allows users to Enable/Disable interface communication with the board management controller (BMC).
- **Wait for BMC**
This item allows users to configure the system to wait for a BMC response for a specified duration. The BMC is initialized at the same time as the BIOS when the system is powered on. The host-to-BMC interface takes approximately 30 seconds to initialize. The system will emit a beep sound but no display will be output to the monitor until the interface initialization is complete.



Note! This item is only available for the G4 SKU with onboard IPMI.



■ **BMC Counter**

This item allows users to set the BMC counter value as either 6, 8, 10, or 12.

3.8.1 System Event Log

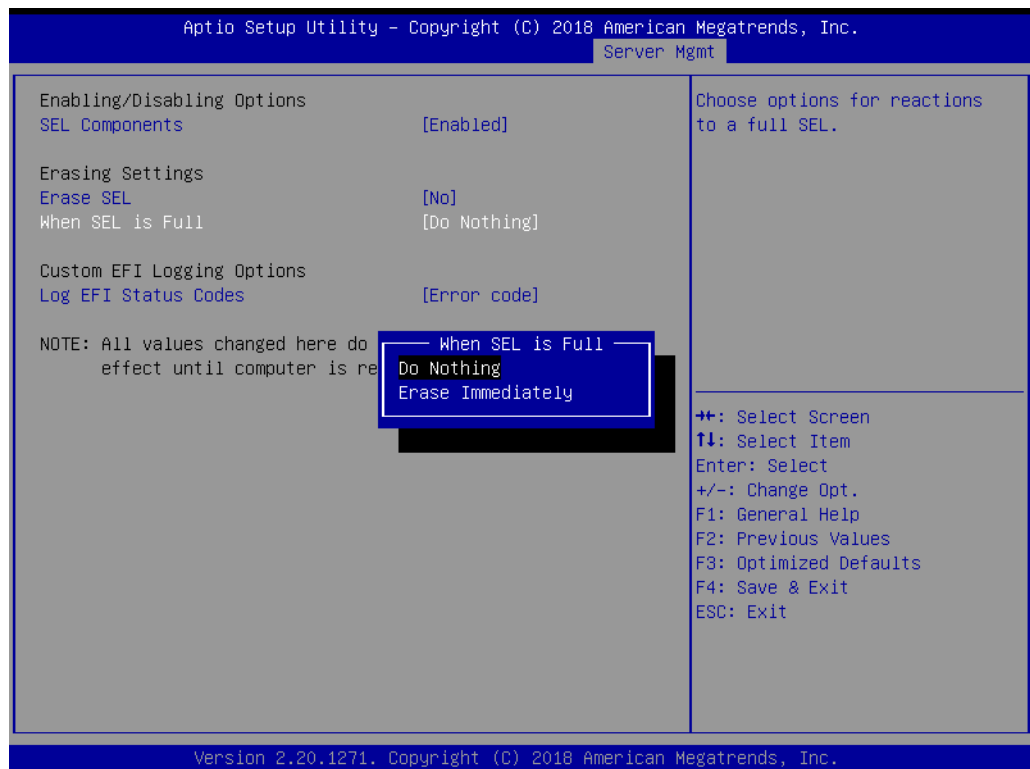
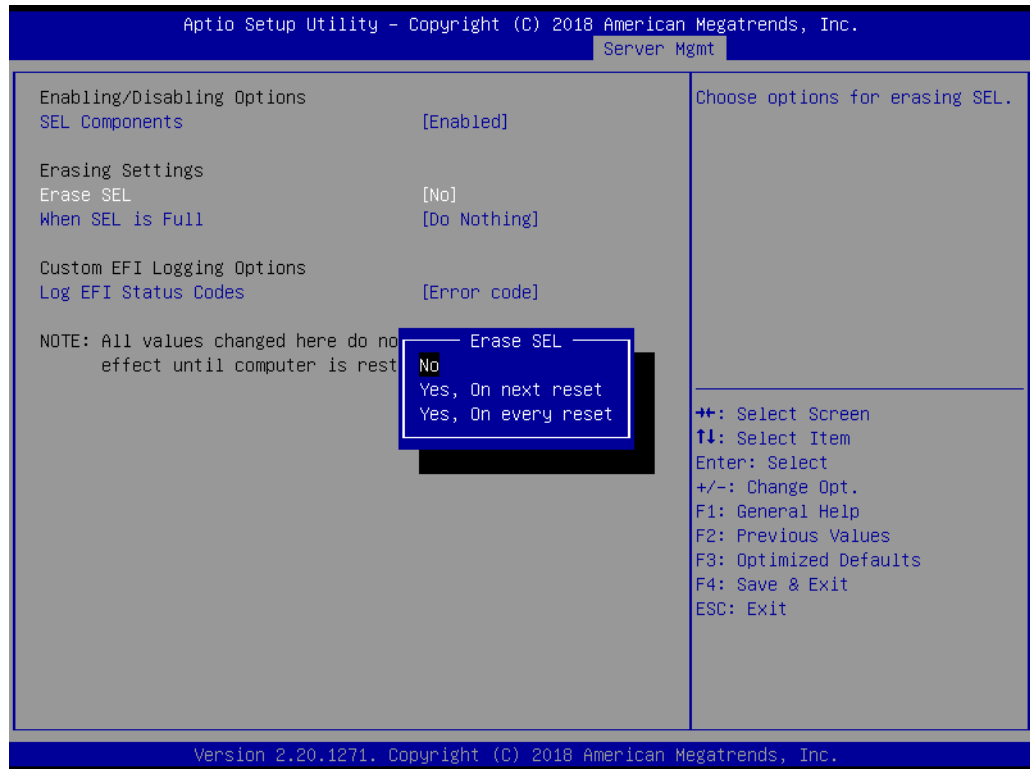

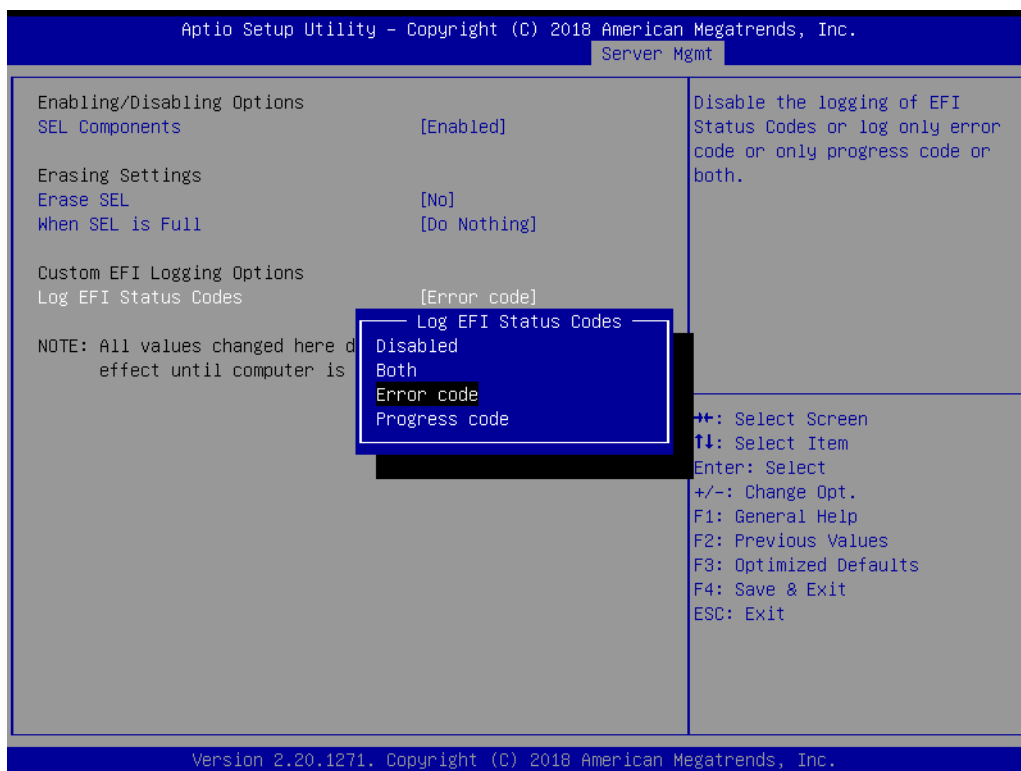

- **SEL Components**
This item allows users to Enable/Disable event logging for error/progress codes during bootup.
- **Erase SEL**
This item allows users to set the parameters for erasing SEL.
- **When SEL is Full**
This item allows users to specify the system actions in response to a full SEL.
- **Log EFI Status Codes**
This item allows users to Enable/Disable logging of EFI status codes or to log only error codes or progress codes.

3.8.2 BMC Self-Test Log

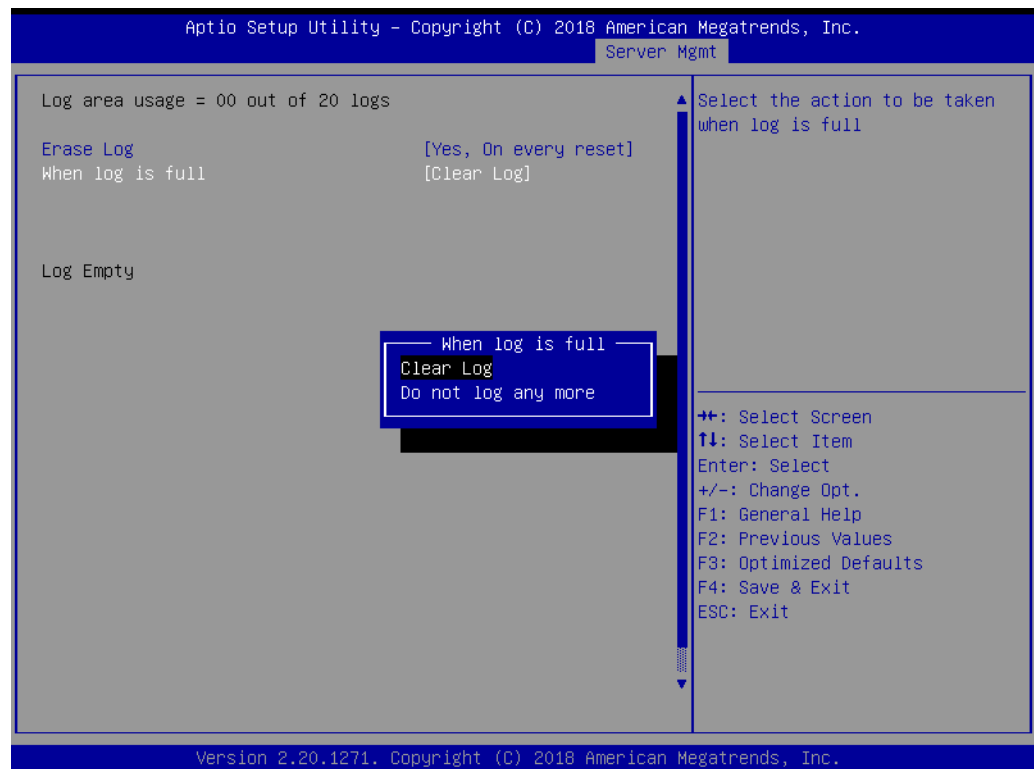
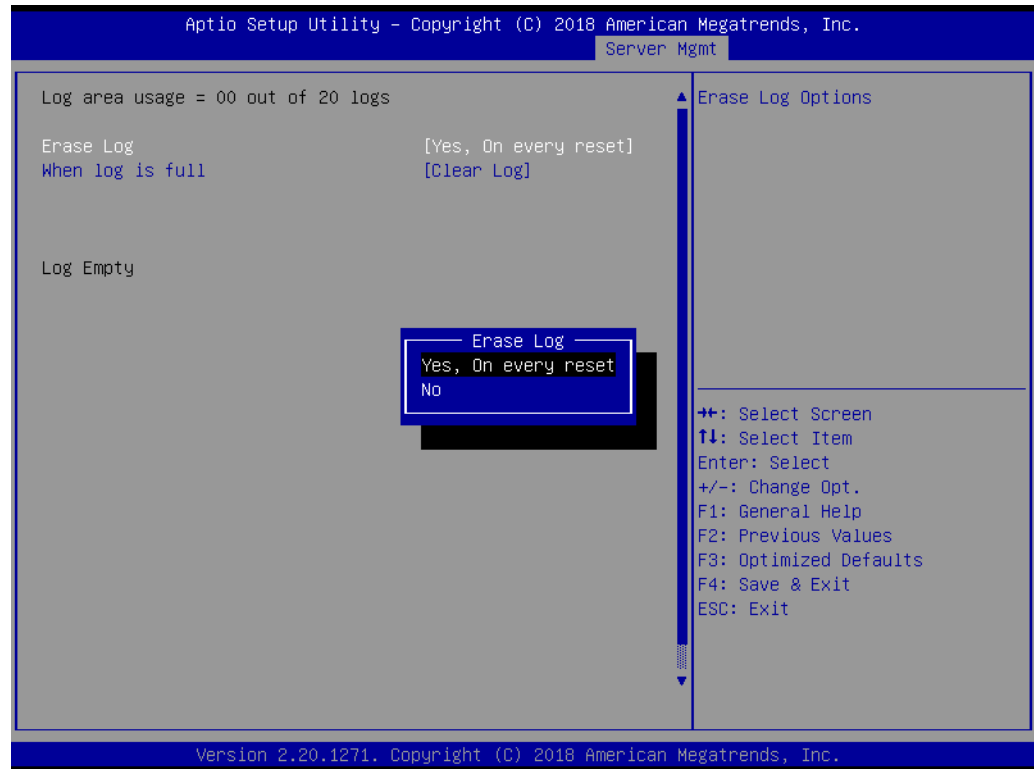

- **Erase Log**
This item allows users to Enable/Disable log erasing upon system reset.
- **When Log is Full**
This item allows users to specify the system actions in response to a full log.

3.8.3 BMC Network Configuration

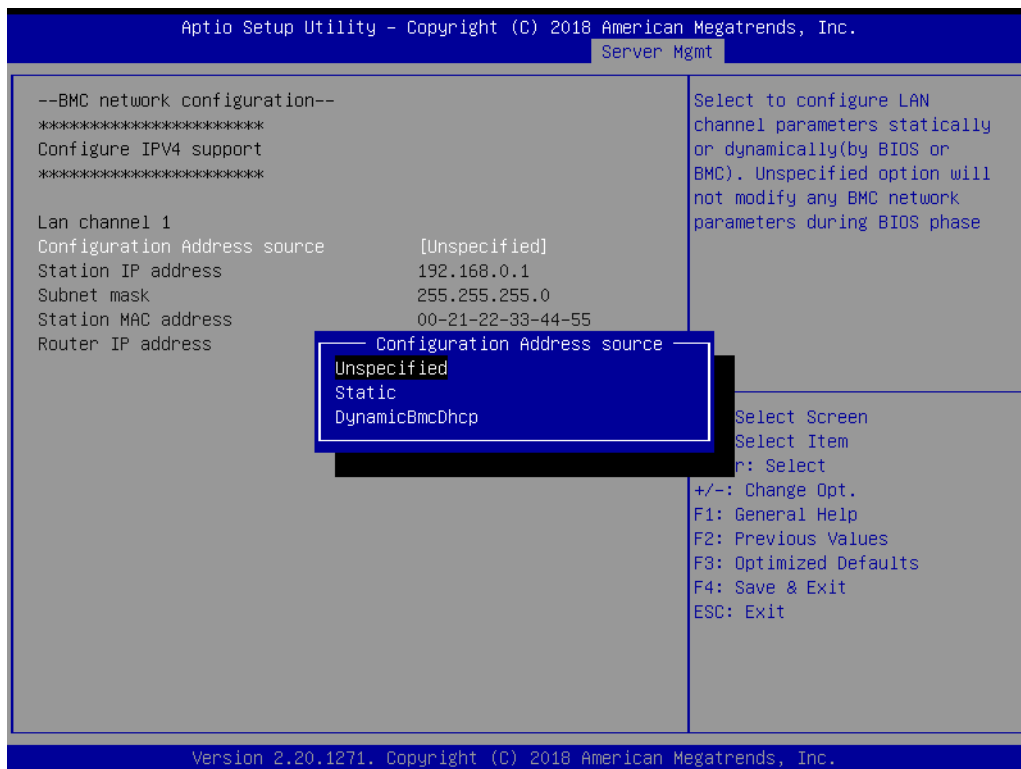

- **Configuration Address Source**

This item allows users to choose whether to configure the LAN channel1 parameters statically or dynamically (by BIOS or BMC). If set as Unspecified, the BMC network parameters will not be modified during BIOS phase.

For the ASMB-786 motherboard, the LAN2 port is reserved for IPMI to share a NIC.

Chapter 4

Driver Installation

4.1 Before Installation

To ensure all ASMB-786 drivers are up-to-date, the drivers are available online for download from the Advantech support website at <https://adv.t.ch/searc8f16d>.

Most display drivers must have the relevant software application already installed in the system before the enhanced display drivers can be installed. Additionally, many of the installation procedures assume that users are familiar with both the relevant software applications and OS commands.

We recommend that users review the relevant OS commands and sections of the application software user manual before beginning driver installation.

Note! *To ensure system stability, we strongly recommend installing drivers according to in the following sequence:*



- Chipset
- Graphics
- ME
- Other drivers

4.2 Introduction

4.2.1 Chipset

The Intel® Chipset Software Installation (CSI) utility installs the Windows INF files that instruct the OS how to configure the chipset components. This is needed for the proper functioning of the following features:

- Serial ATA interface support
- USB 1.1/2.0/3.1 support
- Identification of Intel® chipset components by the Device Manager

Note! *The chipset driver must be installed before any other driver can be installed. The chipset driver supports the following versions of Windows, however, only Windows® 10 (64 bit) and Windows® Server 2016 (64 bit) have been validated for the ASMB-786 motherboard.*



- Windows® Server 2008 R2 (64 bit)
- Windows® Server 2012 (32 bit)
- Windows® Server 2012 R2 (64 bit)
- Windows® Server 2016 (64 bit)
- Windows® 7 (32 bit)
- Windows® 7 (64 bit)
- Windows® 8/8.1 (32 bit)
- Windows® 8/8.1 (64 bit)
- Windows® 10 (64 bit)

4.2.2 Graphics

The Intel® Xeon® E/8th Gen Intel® Core™ i3/i5/i7 series processors are embedded with an integrated graphics controller. The VGA driver must be installed to enable this optimized integrated graphics solution. The included Intel® Graphics Flexible Display Interface provides versatile display options and a 3D graphics engine to support triple display outputs, enhanced display modes for widescreen flat panels (such as extend, twin, and clone dual display), and optimized 3D support in order to deliver rich and realistic visuals.

4.2.3 LAN

ASMB-786 is equipped with up to four Gigabit Ethernet LANs via dedicated PCI Express x1 lanes (GbE LAN1: Intel® I219LM; GbE LAN2~4: Intel® I210-AT) that offer bandwidths of up to 500 MB/sec to eliminate network bottlenecks while incorporating Gigabit Ethernet at 1000 Mbps.

The key features include

- 10/100/1000 Mbps Ethernet controller
- 10/100/1000 Mbps triple-speed MAC
- Full duplex at 10, 100, or 1000 Mbps and half duplex at 10 or 100 Mbps
- Wake-on-LAN (WOL) support
- PCIe x1 host interface

The integrated Intel® Gigabit Ethernet controller supports all major network operating systems. However, the installation procedures vary for different OS. For installation advice or guidance, contact a local FAE for technical support.

Note! Before installing the LAN drivers, ensure that the CSI utility has been installed on the system.



4.2.4 HD Audio

ASMB-786 is equipped with a Realtek ALC892 audio chip that supports Line-Out and Microphone functions for related applications.

4.2.5 Intel® ME

The Intel® ME software components that must be installed vary according to the system's specific hardware and firmware features. The installer detects the system capabilities and installs the relevant drivers and applications.

Note! If the Intel® ME driver has not been successfully installed, the PCI Simple Communications Controller may show an error in the Device Manager.



4.2.6 SATA RAID

To support demanding disk I/O, the Intel® C246 chipset integrates seven serial ATA controllers with software RAID 0, 1, 5, 10 capabilities.

RAID 0 striping increases the storage performance and is designed to speed up data transfer rates for disk-intensive applications.

RAID 1 mirroring protects valuable data that may be lost in the event of a hard drive failure.

RAID 5 arrays contain three or more hard drives, where data is divided into manageable blocks called strips. Parity is a mathematical method for recreating data that was lost from a single drive. In order to increase fault tolerance, the data and parity are striped across all the hard drives in the array. The parity is striped in a rotating sequence to reduce bottlenecks associated with parity calculations.

RAID 10 arrays use four hard drives to create a combination of RAID levels 0 and 1. The data is striped across a two-drive array forming the RAID 0 component. Each of the drives in the RAID 0 array is then mirrored by a RAID 1 component.

Appendix **A**

Watchdog Timer

The ASMB-786 watchdog timer can be used to monitor system software operations and implement corrective actions if the software fails to function within the programmed period. This chapter describes the operation of the watchdog timer and provides programming instructions.

A.1 Watchdog Timer Overview

The watchdog timer is built into the NCT6776 super I/O controller and provides the following functions:

- Can be Enabled/Disabled from a program
- Timer intervals ranging from 1 to 255 sec/min. can be set
- An interrupt or reset signal is generated if the software fails to reset the timer before timeout

A.2 Programming the Watchdog Timer

The I/O port address of the watchdog timer is 2E (hex) and 2F (hex). 2E (hex) is the address port, 2F (hex) is the data port. An address value must be written into address port 2E (hex) first before conducting data write/read operations to/from the assigned register through data port 2F (hex).

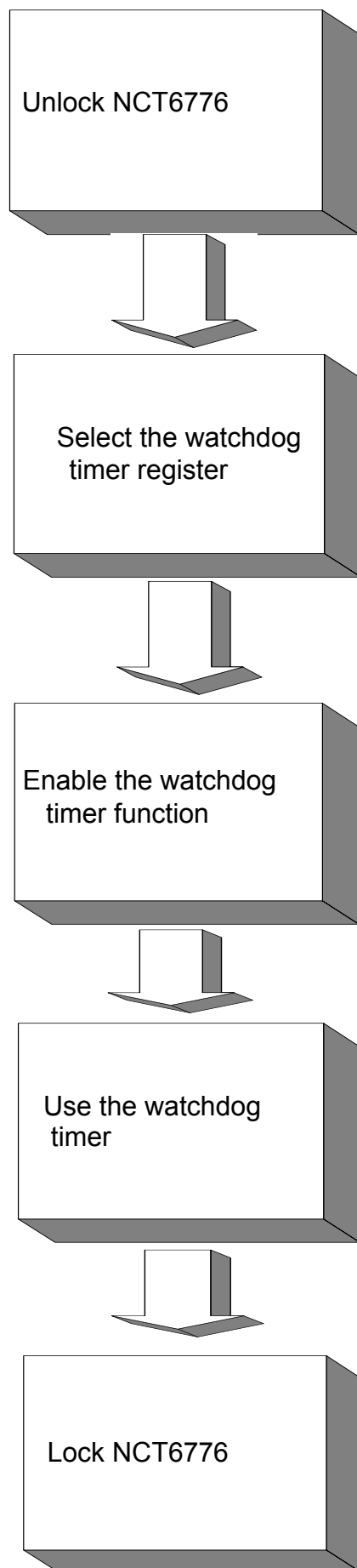

Table A.1: Watchdog Timer Registers

Address Register (2E)	Read/Write	Value (2F) and Description
87 (hex)	-	Write this address to I/O address port 2E (hex) twice to unlock NCT6776.
07 (hex)	write	Write 08 (hex) to select the register of the watchdog timer.
30 (hex)	write	Write 01 (hex) to enable the watchdog timer function. The default setting is Disabled.
F5 (hex)	write	Set seconds or minutes as units for the timer. Write 0 to Bit 3: set seconds as the counting unit (default). Write 1 to Bit 3: set minutes as the counting unit. Write 1 to Bit 4: The watchdog timer count mode is 1000 times faster. If Bit 3 is 0, the count mode is 1/1000 seconds. If Bit 3 is 1, the count mode is 1/1000 minutes.
F6 (hex)	write	0: Stop timer (default) 01 ~ FF (hex): The amount of the count, in seconds or minutes, depends on the value set in register F5 (hex). This number decides how long the watchdog timer waits for strobe before generating an interrupt or reset signal. Writing a new value to this register can reset the timer to count from the new value.
F7 (hex)	read/write	Bit 6: Write 1 to enable timer reset via the keyboard, or 0 to disable (default). Bit 5: Write 1 to generate a timeout signal immediately and automatically return to 0 (the default setting is 0). Bit 4: Read the watchdog timer status. 1 means the timer has reached timeout.
AA (hex)	-	Write this address to I/O port 2E (hex) to lock NCT6776.

A.2.1 Example Programs

Enable the watchdog timer and set the timeout interval as 10 seconds

```

;-----
Mov dx,2eh ; Unlock NCT6776
Mov al,87h
Out dx,al
Out dx,al
;-----
Mov al,07h ; Select registers of watchdog timer
Out dx,al
Inc dx
in al,dx
Or al,08h
Out dx,al
;-----
Dec dx; Enable the function of watchdog timer
Mov al,30h
Out dx,al
Inc dx

```

```

Mov al,01h
Out dx,al
;-----
Dec dx ; Set second as counting unit
Mov al,0f5h
Out dx,al
Inc dx
In al,dx
And al,not 08h
Out dx,al
;-----
Dec dx ; Set timeout interval as 10 seconds and start counting
Mov al,0f6h
Out dx,al
Inc dx
Mov al,10; 10 minutes
Out dx,al
;-----
Dec dx ; lock NCT6776
Mov al,0aah
Out dx,al
Enable watchdog timer and set 5 minutes as the timeout interval
;-----
Mov dx,2eh ; unlock NCT6776
Mov al,87h
Out dx,al
Out dx,al
;-----
Mov al,07h ; Select registers of watchdog timer
Out dx,al
Inc dx
In al,dx
Or al,08h
Out dx,al
;-----
Dec dx ; Enable the function of watchdog timer
Mov al,30h
Out dx,al
Inc dx
Mov al,01h
Out dx,al
;-----
Dec dx ; Set minute as counting unit
Mov al,0f5h
Out dx, al

```

```

Inc dx
In al,dx
Or al, 08h
Out dx,al
;-----
Dec dx ; Set timeout interval as 5 minutes and start counting
Mov al,0f6h
Out dx,al
Inc dx
Mov al,5; 5 minutes
Out dx,al
;-----
Dec dx ; lock NCT6776
Mov al,0aah
Out dx,al
Enable watchdog timer to be reset by mouse
;-----
Mov dx,2eh ; unlock NCT6776
Mov al,87h
Out dx,al
Out dx,al
;-----
Mov al,07h ; Select registers of watchdog timer
Out dx,al
Inc dx
Mov al,08h
Out dx,al
;-----
Dec dx ; Enable the function of watchdog timer
Mov al,30h
Out dx,al
Inc dx
In al,dx
Or al,01h
Out dx,al
;-----
Dec dx ; Enable watchdog timer to be reset by mouse
Mov al,0f7h
Out dx,al
Inc dx
In al,dx
Or al,80h
Out dx,al
;-----
Dec dx ; lock NCT6776

```



```

Mov al,0aah
Out dx,al
Enable watchdog timer to be reset by keyboard
;-----
Mov dx,2eh ; unlock NCT6776
Mov al,87h
Out dx,al
Out dx,al
;-----
Mov al,07h ; Select registers of watchdog timer
Out dx,al
Inc dx
Mov al,08h
Out dx,al
;-----
Dec dx ; Enable the function of watchdog timer
Mov al,30h
Out dx,al
Inc dx
Mov al,01h
Out dx,al
;-----
Dec dx ; Enable watchdog timer to be strobed reset by keyboard
Mov al,0f7h
Out dx,al
Inc dx
In al,dx
Or al,40h
Out dx,al
;-----
Dec dx ; lock NCT6776
Mov al,0aah
Out dx,al
Generate a time-out signal without timer counting
;-----
Mov dx,2eh ; unlock NCT6776
Mov al,87h
Out dx,al
Out dx,al
;-----
Mov al,07h ; Select registers of watchdog timer
Out dx,al
Inc dx
Mov al,08h
Out dx,al

```

```
;-----  
Dec dx ; Enable the function of watchdog timer  
Mov al,30h  
Out dx,al  
Inc dx  
In al,dx  
Or al,01h  
Out dx,al  
;-----  
Dec dx ; Generate a time-out signal  
Mov al,0f7h  
Out dx,al ;Write 1 to bit 5 of F7 register  
Inc dx  
In al,dx  
Or al,20h  
Out dx,al  
;-----  
Dec dx ; lock NCT6776  
Mov al,0aah  
Out dx,al
```

Appendix **B**

I/O Pin Assignments

B.1 USB 2.0 Header (USB7 ~ 12)

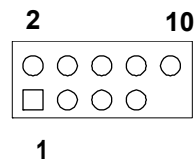

Table B.1: USB 2.0 Header (USB7 ~ 12)

Pin	Signal	Pin	Signal
1	+5V_USB	2	+5V_USB
3	USB2_D1-	4	USB2_D2-
5	USB2_D1+	6	USB2_D2+
7	GND	8	GND
9	Key	10	N/C

B.2 USB 3.1 Header (USB5_6)

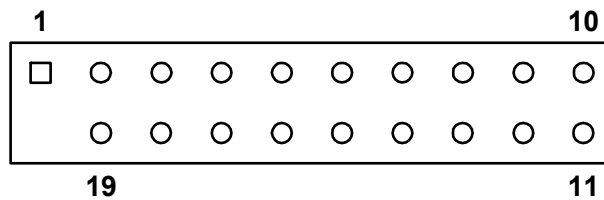

Table B.2: USB 3.1 Header (USB5_6)

Pin	Signal	Pin	Signal
1	+5V_USB	20	Key
2	USB3_RX_D1-	19	+5V_USB
3	USB3_RX_D1+	18	USB3_RX_D2-
4	GND	17	USB3_RX_D2+
5	USB3_TX_D1-	16	GND
6	USB3_TX_D1+	15	USB3_TX_D2-
7	GND	14	USB3_TX_D2+
8	USB2_D1-	13	GND
9	USB2_D1+	12	USB2_D2-
10	USB_OC	11	USB2_D2+

B.3 VGA Connector (VGA1)

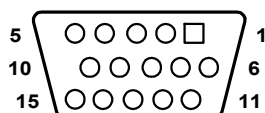

Table B.3: VGA Connector (VGA1)

Pin	Signal	Pin	Signal
1	Red	9	VCC
2	Green	10	GND
3	Blue	11	N/C
4	N/C	12	SDA
5	GND	13	H-SYNC
6	GND	14	V-SYNC
7	GND	15	SCL
8	GND		

B.4 RS-232 Interface (COM1 ~ 2)

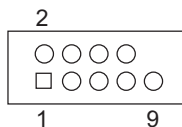

Table B.4: RS-232 Interface (COM1 ~ 2)

COM1/COM2	
Pin	Signal
1	DCD
2	DSR
3	RXD
4	RTS
5	TXD
6	CTS
7	DTR
8	RI
9	GND

B.5 External Keyboard/Mouse Connector (KBMS1)

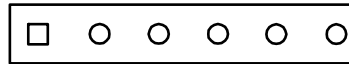

Table B.5: External Keyboard/Mouse Connector (KBMS1)

Pin	Signal
1	KB CLK
2	KB DATA
3	MS DATA
4	GND
5	VCC
6	MS CLK

B.6 System Fan Power Connector (SYSFAN0 ~ 3)



Table B.6: System Fan Power Connector (SYSFAN0 ~ 3)

Pin	Signal
1	GND
2	+12 V
3	Detect
4	PWM

B.7 Power LED and Keyboard Lock (JFP3)

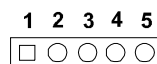

Table B.7: Power LED and Keyboard Lock (JFP3)

Pin	Signal
1	LED power + (3.3 V)
2	NC
3	LED power -
4	#keylock
5	Ground

B.8 External Speaker Connector (JFP2)

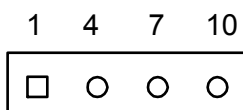

Table B.8: External Speaker Connector (JFP2)

Pin	Signal
1	SPK_VCC (+)
4	SPK_OBS
7	SPK_BUZ
10	SPK_OUT (-)

B.9 HDD LED Connector (JFP2)

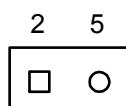

Table B.9: HDD LED Connector (JFP2)

Pin	Signal
2	HDD_LED+
5	HDD_LED-

B.10 SNMP SMBus Connector (JFP2)

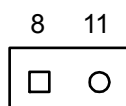

Table B.10: SNMP SMBus Connector (JFP2)

Pin	Signal
8	HWM_SDA
11	HWM_SCL

B.11 ATX Soft Power Switch (JFP1)

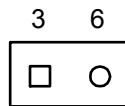

Table B.11: ATX Soft Power Switch (JFP1)

Pin	Signal
3	PWR-BTN
6	GND

B.12 Reset Connector (JFP1)

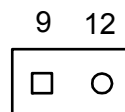

Table B.12: Reset Connector (JFP1)

Pin	Signal
9	RST-BTN
12	GND

B.13 Front Panel Audio Connector (FPAUD1)

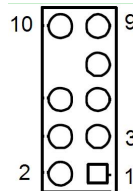

Table B.13: Front Panel Audio Connector (FPAUD1)

Pin	Signal	Pin	Signal
1	MIC2_L	2	AGND
3	MIC2_R	4	PRESENSE
5	LINE2_R	6	MIC2_JD
7	FRONT-IO_JD	8	Key
9	LINE2_L	10	LINE2_JD

B.14 8-Pin Alarm Board Connector (VOLT1)

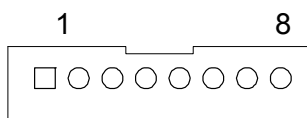

Table B.14: 8-Pin Alarm Board Connector (VOLT1)

Pin	Signal	Pin	Signal
1	5VSB	5	VCC
2	GND	6	VCC3
3	GND	7	-12V
4	-5V	8	+12V

B.15 Case Open Connector (JCASE1)

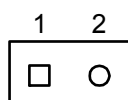

Table B.15: Case Open Connector (JCASE1)

Pin	Signal
1	CASEOP
2	GND

B.16 Front Panel LAN LED Connector (LAN_LED1)

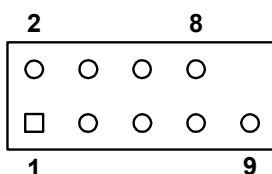

Table B.16: LAN LED Connector (LANLED1)

Pin	Signal	Pin	Signal
1	LAN1_LED_ACT#	2	LAN2_LED_ACT#
3	VCC3	4	VCC3
5	LAN3_LED_ACT#	6	LAN4_LED_ACT#
7	VCC3	8	VCC3
9	NC	10	N/C

B.17 SPI Flash Card Pin Connector (SPI_CN1)

Table B.17: SPI Flash Connector (SPI_CN1)

Pin	Signal	Pin	Signal
1	+3VSB	2	GND
3	SPI_CS#	4	SPI_CLK
5	SPI_MISO	6	SPI_MOSI
7	N/A	8	NC

B.18 GPIO Connector (GPIO1)

Table B.18: GPIO Connector (GPIO1)

Pin	Signal	Pin	Signal
1	SIO_GPIO0	2	SIO_GPIO4
3	SIO_GPIO1	4	SIO_GPIO5
5	SIO_GPIO2	6	SIO_GPIO6
7	SIO_GPIO3	8	SIO_GPIO7
9	VCC_GPIO0	10	GND

B.19 SMBUS Connector (SMBUS1)

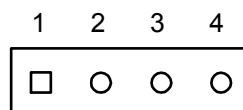

Table B.19: SMBUS Connector (SMBUS1)

Pin	Signal
1	+5V
2	Clock
3	Data
4	GND

B.20 PMBUS Connector (PMBUS1)



Table B.20: PMBUS Connector (PMBUS1)

Pin	Signal
1	SMB_SCL_PM
2	SMB_SDA_PM
3	SMB_ALT_PM
4	GND
5	+3.3V

B.21 Parallel Port (LPT1)

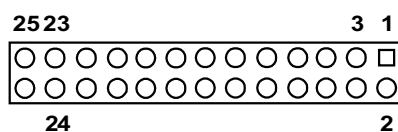

Table B.21: Parallel Port (LPT1)

Pin	Signal	Pin	Signal
1	STROBE*	14	GND*
2	AFD*	15	D6
3	D0	16	IGND
4	ERR*	17	D7
5	D1	18	GND
6	INIT*	19	ACK*
7	D2	20	GND
8	SLIN*	21	BUSY
9	D3	22	GND
10	GND	23	PE
11	D4	24	GND
12	GND	25	SLCT
13	D5	26	N/C

B.22 System I/O Ports

Table B.22: System I/O Ports

Address Range (Hex)	Device
000-01F	DMA controller
020-021	Interrupt controller 1, programmable interrupt controller
022-03F	Motherboard resources
040-043	System timer
060-060	Standard PS/2 keyboard
064-064	Standard PS/2 keyboard
070-077	Real-time clock, non-maskable interrupt (NMI) mask
081-091	DMA controller
0A0-0A1	Interrupt controller 2, programmable interrupt controller
0C0-0DF	DMA controller
0F0-0F0	Numeric data processor
A35-A36	Onboard hardware monitor
2F8-2FF	Serial port 2
778-77F	Printer port (LPT1)
3B0-3BB	Intel HD Graphics
3C0-3DF	Intel HD Graphics
3F8-3FF	Serial port 1

B.23 Interrupt Assignments

Table B.23: Interrupt Assignments

Priority	Interrupt#	Interrupt Source
1	NMI	Parity error detected
2	IRQ0	Interval timer
3	IRQ1	PS/2 keyboard
-	IRQ2	Interrupt from controller 2 (cascade)
4	IRQ8	Real-time clock
5	IRQ9	Cascaded to INT 0A (IRQ 2)
6	IRQ10	Intel 8 series/C226 chipset family SMBus controller
7	IRQ11	Available
8	IRQ12	PS/2 mouse
9	IRQ13	Numeric data processor
10	IRQ14	Available
11	IRQ15	Available
12	IRQ3	Serial communication port 2
13	IRQ4	Serial communication port 1
14	IRQ5	Available
15	IRQ6	Available
16	IRQ7	Parallel port 1 (print port)

B.24 First Motherboard Memory Map

Table B.24: First Motherboard Memory Map

Address Range (Hex)	Device
E0000h - FFFFFh	BIOS
D0000h - DFFFFh	Unused
C0000h - CFFFFh	VGA BIOS
A0000h - BFFFFh	Video memory
00000h - 9FFFFh	Base memory

ADVANTECH

Enabling an Intelligent Planet

www.advantech.com

Please verify specifications before quoting. This guide is intended for reference purposes only.

All product specifications are subject to change without notice.

No part of this publication may be reproduced in any form or by any means, such as electronically, by photocopying, recording, or otherwise, without prior written permission from the publisher.

All brand and product names are trademarks or registered trademarks of their respective companies.

© Advantech Co., Ltd. 2018