

User Manual

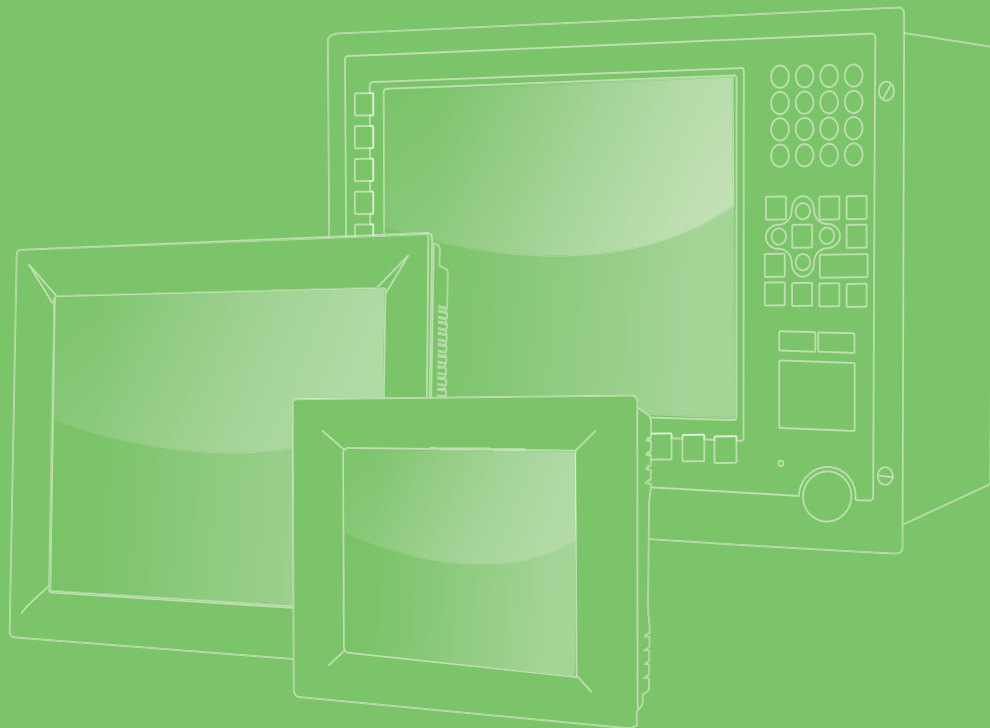

# FPM-3121G/3151G/ 3171G/3191G

顯示器

12"XGA/15" XGA/17" SXGA/  
19" SXGA

Industrial LED Monitor with  
Resistive Touchscreen, Direct-  
VGA, DVI Ports and DC24 V Input

**ADVANTECH**

*Enabling an Intelligent Planet*

# 限用物質含有情況標示聲明書

## Declaration of the Presence Condition of the Restricted Substances Marking

設備名稱：顯示器		型號（型式）：FPM-3151G-R3BE（系列型號請參見 iv 頁說明書）				
Equipment name		Type designation (Type)				
單元 U nit	限用物質及其化學符號 Restricted substances and its chemical symbols					
	鉛 Lead (Pb)	汞 Mercury (Hg)	鎘 Cadmium (Cd)	六價鉻 Hexavalent chromium (Cr <sup>+6</sup> )	多溴聯苯 Polybrominated biphenyls (PBB)	多溴二苯醚 Polybrominated diphenyl ethers (PBDE)
電路板	—	○	○	○	○	○
玻璃面板	—	○	○	○	○	○
外殼	—	○	○	○	○	○
配件	—	○	○	○	○	○
備考 1. “超出 0.1 wt %” 及 “超出 0.01 wt %” 係指限用物質之百分比含量超出百分比含量基準值。 Note 1: “Exceeding 0.1 wt %” and “exceeding 0.01 wt %” indicate that the percentage content of the restricted substance exceeds the reference percentage value of presence condition.						
備考 2. “○” 係指該項限用物質之百分比含量未超出百分比含量基準值。 Note 2: “○” indicates that the percentage content of the restricted substance does not exceed the percentage of reference value of presence.						
備考 3. “—” 係指該項限用物質為排除項目。 Note 3: The “—” indicates that the restricted substance corresponds to the exemption.						

設備名稱：顯示器		型號（型式）：FPM-3171G-R3BE（系列型號請參見 iv 頁說明書）				
Equipment name		Type designation (Type)				
單元 U nit	限用物質及其化學符號 Restricted substances and its chemical symbols					
	鉛 Lead (Pb)	汞 Mercury (Hg)	鎘 Cadmium (Cd)	六價鉻 Hexavalent chromium (Cr <sup>+6</sup> )	多溴聯苯 Polybrominated biphenyls (PBB)	多溴二苯醚 Polybrominated diphenyl ethers (PBDE)
電路板	—	○	○	○	○	○
玻璃面板	—	○	○	○	○	○
外殼	—	○	○	○	○	○
配件	—	○	○	○	○	○
備考 1. “超出 0.1 wt %” 及 “超出 0.01 wt %” 係指限用物質之百分比含量超出百分比含量基準值。 Note 1: “Exceeding 0.1 wt %” and “exceeding 0.01 wt %” indicate that the percentage content of the restricted substance exceeds the reference percentage value of presence condition.						
備考 2. “○” 係指該項限用物質之百分比含量未超出百分比含量基準值。 Note 2: “○” indicates that the percentage content of the restricted substance does not exceed the percentage of reference value of presence.						
備考 3. “—” 係指該項限用物質為排除項目。 Note 3: The “—” indicates that the restricted substance corresponds to the exemption.						

設備名稱：顯示器		型號（型式）：FPM-3191G-R3BE（系列型號請參見 iv 頁說明書）				
Equipment name		Type designation (Type)				
單元 U nit	限用物質及其化學符號 Restricted substances and its chemical symbols					
	鉛 Lead (Pb)	汞 Mercury (Hg)	鎘 Cadmium (Cd)	六價鉻 Hexavalent chromium (Cr <sup>+6</sup> )	多溴聯苯 Polybrominated biphenyls (PBB)	多溴二苯醚 Polybrominated diphenyl ethers (PBDE)
電路板	—	○	○	○	○	○
玻璃面板	—	○	○	○	○	○
外殼	—	○	○	○	○	○
配件	—	○	○	○	○	○
備考 1. “超出 0.1 wt %” 及 “超出 0.01 wt %” 係指限用物質之百分比含量超出百分比含量基準值。 Note 1 : “Exceeding 0.1 wt %” and “exceeding 0.01 wt %” indicate that the percentage content of the restricted substance exceeds the reference percentage value of presence condition.						
備考 2. “○” 係指該項限用物質之百分比含量未超出百分比含量基準值。 Note 2 : “○” indicates that the percentage content of the restricted substance does not exceed the percentage of reference value of presence.						
備考 3. “—” 係指該項限用物質為排除項目。 Note 3 : The “—” indicates that the restricted substance corresponds to the exemption.						

設備名稱：顯示器		型號（型式）：FPM-3121G-R3BE（系列型號請參見 iv 頁說明書）				
Equipment name		Type designation (Type)				
單元 U nit	限用物質及其化學符號 Restricted substances and its chemical symbols					
	鉛 Lead (Pb)	汞 Mercury (Hg)	鎘 Cadmium (Cd)	六價鉻 Hexavalent chromium (Cr <sup>+6</sup> )	多溴聯苯 Polybrominated biphenyls (PBB)	多溴二苯醚 Polybrominated diphenyl ethers (PBDE)
電路板	—	○	○	○	○	○
玻璃面板	—	○	○	○	○	○
外殼	—	○	○	○	○	○
配件	—	○	○	○	○	○
備考 1. “超出 0.1 wt %” 及 “超出 0.01 wt %” 係指限用物質之百分比含量超出百分比含量基準值。 Note 1 : “Exceeding 0.1 wt %” and “exceeding 0.01 wt %” indicate that the percentage content of the restricted substance exceeds the reference percentage value of presence condition.						
備考 2. “○” 係指該項限用物質之百分比含量未超出百分比含量基準值。 Note 2 : “○” indicates that the percentage content of the restricted substance does not exceed the percentage of reference value of presence.						
備考 3. “—” 係指該項限用物質為排除項目。 Note 3 : The “—” indicates that the restricted substance corresponds to the exemption.						

# Copyright

The documentation and the software included with this product are copyrighted 2016 by Advantech Co., Ltd. All rights are reserved. Advantech Co., Ltd. reserves the right to make improvements in the products described in this manual at any time without notice. No part of this manual may be reproduced, copied, translated or transmitted in any form or by any means without the prior written permission of Advantech Co., Ltd. Information provided in this manual is intended to be accurate and reliable. However, Advantech Co., Ltd. assumes no responsibility for its use, nor for any infringements of the rights of third parties, which may result from its use.

# Acknowledgements

Intel and Pentium are trademarks of Intel Corporation.

Microsoft Windows and MS-DOS are registered trademarks of Microsoft Corp.

All other product names or trademarks are properties of their respective owners.

This Manual Covers the Following Models.

- FPM-3121G-R3BE,
- FPM-3121G-X0BE, FPM3121GR3B1601E-T, FPM3121GR3B1602E-T, FPM3121GR3B1603E-T, FPM3121GR3B1604E-T, FPM3121GR3B1701E-T, FPM3121GR3B1702E-T, FPM3121GR3B1703E-T, FPM3121GR3B1704E-T, FPM3121GR3B1801E-T, FPM3121GR3B1802E-T, FPM3121GR3B1803E-T, FPM3121GR3B1804E-T, FPM3121GX0B1601E-T, FPM3121GX0B1602E-T, FPM3121GX0B1701E-T, FPM3121GX0B1702E-T, FPM3121GX0B1801E-T, FPM3121GX0B1802E-T
- FPM-3151G-R3BE, FPM-3151G-X0BE, FPM3151GR3B1601E-T, FPM3151GR3B1602E-T, FPM3151GR3B1603E-T, FPM3151GR3B1604E-T, FPM3151GR3B1701E-T, FPM3151GR3B1702E-T, FPM3151GR3B1703E-T, FPM3151GR3B1704E-T, FPM3151GR3B1801E-T, FPM3151GR3B1802E-T, FPM3151GR3B1803E-T, FPM3151GR3B1804E-T, FPM3151GX0B1601E-T, FPM3151GX0B1602E-T, FPM3151GX0B1701E-T, FPM3151GX0B1702E-T, FPM3151GX0B1801E-T, FPM3151GX0B1802E-T
- FPM-3171G-R3BE,
- FPM-3171G-X0BE, FPM3171GR3B1601E-T, FPM3171GR3B1602E-T, FPM3171GR3B1603E-T, FPM3171GR3B1604E-T, FPM3171GR3B1701E-T, FPM3171GR3B1702E-T, FPM3171GR3B1703E-T, FPM3171GR3B1704E-T, FPM3171GR3B1801E-T, FPM3171GR3B1802E-T, FPM3171GR3B1803E-T, FPM3171GR3B1804E-T, FPM3171GX0B1601E-T, FPM3171GX0B1602E-T, FPM3171GX0B1701E-T, FPM3171GX0B1702E-T, FPM3171GX0B1801E-T, FPM3171GX0B1802E-T
- FPM-3191G-R3BE,
- FPM-3191G-X0BE, FPM3191GR3B1601E-T, FPM3191GR3B1602E-T, FPM3191GR3B1603E-T, FPM3191GR3B1604E-T, FPM3191GR3B1701E-T, FPM3191GR3B1702E-T, FPM3191GR3B1703E-T, FPM3191GR3B1704E-T, FPM3191GR3B1801E-T, FPM3191GR3B1802E-T, FPM3191GR3B1803E-T, FPM3191GR3B1804E-T, FPM3191GX0B1601E-T, FPM3191GX0B1602E-T, FPM3191GX0B1701E-T, FPM3191GX0B1702E-T, FPM3191GX0B1801E-T, FPM3191GX0B1802E-T

Part No. 2003P30010

Printed in China

Edition 1

March 2016

## Product Warranty (2 years)

Advantech warrants to you, the original purchaser, that each of its products will be free from defects in materials and workmanship for two years from the date of purchase.

This warranty does not apply to any products which have been repaired or altered by persons other than repair personnel authorized by Advantech, or which have been subject to misuse, abuse, accident or improper installation. Advantech assumes no liability under the terms of this warranty as a consequence of such events.

Because of Advantech's high quality-control standards and rigorous testing, most of our customers never need to use our repair service. If an Advantech product is defective, it will be repaired or replaced at no charge during the warranty period. For out-of-warranty repairs, you will be billed according to the cost of replacement materials, service time and freight. Please consult your dealer for more details.

If you think you have a defective product, follow these steps:

1. Collect all the information about the problem encountered. (For example, CPU speed, Advantech products used, other hardware and software used, etc.) Note anything abnormal and list any onscreen messages you get when the problem occurs.
2. Call your dealer and describe the problem. Please have your manual, product, and any helpful information readily available.
3. If your product is diagnosed as defective, obtain an RMA (return merchandise authorization) number from your dealer. This allows us to process your return more quickly.
4. Carefully pack the defective product, a fully-completed Repair and Replacement Order Card and a photocopy proof of purchase date (such as your sales receipt) in a shippable container. A product returned without proof of the purchase date is not eligible for warranty service.
5. Write the RMA number visibly on the outside of the package and ship it prepaid to your dealer.

## Declaration of Conformity

This device complies with part 15 of the FCC rules: Operation is subject to the following two conditions:

1. This device may not cause harmful interference.
2. This device must accept any interference received, including interference that may cause undesired operation.

### FCC Class A

Note: This equipment has been tested and found to comply with the limits for a Class A digital device, pursuant to part 15 of the FCC Rules. These limits are designed to provide reasonable protection against harmful interference when the equipment is operated in a commercial environment. This equipment generates, uses, and can radiate radio frequency energy and, if not installed and used in accordance with the instruction manual, may cause harmful interference to radio communications. Operation of this equipment in a residential area is likely to cause harmful interference in which case the user will be required to correct the interference at his own expense.

[ 警告使用者：這是甲類資訊產品，在居住的環境中使用時，可能會造成射頻干擾，在這種情況下，使用者會被要求採取某些適當對策。]

---

## Technical Support and Assistance

1. Visit the Advantech web site at [www.advantech.com/support](http://www.advantech.com/support) where you can find the latest information about the product.
2. Contact your distributor, sales representative, or Advantech's customer service center for technical support if you need additional assistance. Please have the following information ready before you call:
  - Product name and serial number
  - Description of your peripheral attachments
  - Description of your software (operating system, version, application software, etc.)
  - A complete description of the problem
  - The exact wording of any error messages

# Safety Instructions

1. Read these safety instructions carefully.
2. Keep this User Manual for later reference.
3. Disconnect this equipment from any AC outlet before cleaning. Use a damp cloth. Do not use liquid or spray detergents for cleaning.
4. For plug-in equipment, the power outlet socket must be located near the equipment and must be easily accessible.
5. Keep this equipment away from humidity.
6. Put this equipment on a reliable surface during installation. Dropping it or letting it fall may cause damage.
7. The openings on the enclosure are for air convection. Protect the equipment from overheating. **DO NOT COVER THE OPENINGS.**
8. Make sure the voltage of the power source is correct before connecting the equipment to the power outlet.
9. Position the power cord so that people cannot step on it. Do not place anything over the power cord.
10. All cautions and warnings on the equipment should be noted.
11. If the equipment is not used for a long time, disconnect it from the power source to avoid damage by transient overvoltage.
12. Never pour any liquid into an opening. This may cause fire or electrical shock.
13. Never open the equipment. For safety reasons, the equipment should be opened only by qualified service personnel.
14. If one of the following situations arises, get the equipment checked by service personnel:
  - The power cord or plug is damaged.
  - Liquid has penetrated into the equipment.
  - The equipment has been exposed to moisture.
  - The equipment does not work well, or you cannot get it to work according to the user's manual.
  - The equipment has been dropped and damaged.
  - The equipment has obvious signs of breakage.
15. **DO NOT LEAVE THIS EQUIPMENT IN AN ENVIRONMENT WHERE THE STORAGE TEMPERATURE MAY GO BELOW -20° C (-4° F) OR ABOVE 60° C (140° F). THIS COULD DAMAGE THE EQUIPMENT. THE EQUIPMENT SHOULD BE IN A CONTROLLED ENVIRONMENT.**
16. The sound pressure level at the operator's position according to IEC 704-1:1982 is no more than 70 dB (A).

**DISCLAIMER:** This set of instructions is given according to IEC 704-1. Advantech disclaims all responsibility for the accuracy of any statements contained herein.

## 安全指示

1. 請仔細閱讀此安全操作說明。
2. 請妥善保存此用戶手冊供日後參考。
3. 用濕抹布清洗設備前，請確認拔除電源線。請勿使用液體或去污噴霧劑清洗設備。
4. 對於使用電源線的設備，設備周圍必須有容易接觸到的電源插座。
5. 請勿在潮濕環境中試用設備。
6. 請在安裝前確保設備放置在可靠的平面上，意外摔落可能會導致設備損壞。
7. 設備機殼的開孔適用於空氣對，從而防止設備過熱。**請勿覆蓋開孔。**
8. 當您連接設備到電源插座前，請確認電源插座的電壓符合要求。
9. 請將電源線佈置在人們不易絆倒的位置，請勿在電源線上覆蓋任何雜物。
10. 請注意設備上所有的警告標示。
11. 如果長時間不使用設備，請拔除與電源插座的連結，避免設備被超標的電壓波動損壞。
12. 請勿讓任何液體流入通風口，以免引起火災或短路。
13. 請勿自行打開設備。為了確保您的安全，請透過經認證的工程師來打開設備。
14. 如遇下列情況，請由專業人員維修：
  - 電源線或插頭損壞；
  - 設備內部有液體流入；
  - 設備曾暴露在過度潮濕環境中使用；
  - 設備無法正常工作，或您無法透過用戶手冊來正常工作；
  - 設備摔落或損壞；
  - 設備有明顯外觀損；
15. 請勿將設備放置在超出建議溫度範圍的環境，即不要低於  $-20^{\circ}\text{C}$  ( $-4^{\circ}\text{F}$ ) 或高於  $60^{\circ}\text{C}$  ( $140^{\circ}\text{F}$ )，否則可能會造成設備損壞。
16. **注意：**若電池更換不正確，將有爆炸危險。因此，只可以使用製造商推薦的同一種或者同等型號的電池進行替換。請按照製造商的指示處理舊電池。
17. 根據 IEC 704-1:1982 規定，操作員所在位置音量不可高於 70 分貝。
18. **限制區域：**請勿將設備安裝於限制區域使用。
19. **免責聲明：**請安全訓示符合 IEC 704-1 要求。研華公司對其內容之準確性不承擔任何法律責任。
20. 由於設備的敏感性質，它必須被存儲在一個受限制的訪問位置，只有合格的工程師才能訪問。



# Contents

<b>Chapter 1</b>	<b>General Information .....</b>	<b>1</b>
1.1	Introduction .....	2
1.2	Specifications .....	2
1.2.1	General .....	2
1.2.2	Touchscreen .....	2
1.3	LCD Specifications .....	3
1.4	Power Consumption .....	4
1.5	Connectors .....	4
1.6	Dimensions .....	6
	Figure 1.1 FPM-3121G Dimensions .....	6
	Figure 1.2 FPM-3151G Dimensions .....	7
	Figure 1.3 FPM-3171G Dimensions .....	8
	Figure 1.4 FPM-3191G Dimensions .....	9
1.7	IO View .....	10
<b>Chapter 2</b>	<b>Mounting .....</b>	<b>11</b>
2.1	Mounting the Monitor .....	12
2.1.1	Wall Mounting with FPM-1000T-SMKE .....	12
	Figure 2.1 Wall Mounting for FPM-3121G/3151G .....	12
	Figure 2.2 Wall Mounting for FPM-3171G/3191G .....	13
2.1.2	Panel Mounting .....	14
	Figure 2.3 Panel Mounting (392 x 292 mm) .....	14
	Figure 2.4 Panel Mounting (447.2 x 329.2mm) .....	15
	Figure 2.5 Panel Mounting (441 x 376.4mm) .....	15
2.1.3	VESA Mount for FPM-3000G .....	16
	Figure 2.6 Desktop Stand for FPM-3121G/3151G .....	16
	Figure 2.7 Desktop Stand for FPM-3171G .....	17
	Figure 2.8 Desktop Stand for FPM-3191G .....	17
	Figure 2.9 VESA mount for FPM-3121G .....	18
	Figure 2.10 VESA mount for FPM-3151G .....	19
	Figure 2.11 VESA mount for FPM-3171G .....	19
	Figure 2.12 VESA mount for FPM-3191G .....	20
2.1.4	Rack Mounting .....	21
	Figure 2.13 Rack Mounting for FPM-3171G/FPM-3191G .....	21
<b>Appendix A</b>	<b>OSD Operation Keypad .....</b>	<b>23</b>
A.1	OSD Board Overview (FPM-31xxG) .....	24
A.1.1	OSD Button Description .....	24
A.1.2	LED Functions .....	24
A.2	OSD Key Functions .....	25
A.2.1	Menu Start .....	25
A.2.2	Input Source Select .....	26
A.2.3	Contrast/ Brightness Setting .....	27
A.2.4	Geometry Menu – For DVI Input .....	28
A.2.5	Color Temperature Menu .....	29
A.2.6	RGB Color Menu .....	30
A.2.7	Language Menu .....	32
A.2.8	OSD Manager .....	33
A.2.9	Auto Configuration Menu .....	34
A.2.10	Mode Information Menu .....	35
A.2.11	Memory Recall Menu .....	36

---

A.2.12	Exit Menu.....	37
A.2.13	Hot Keys.....	38

## **Appendix B**      **Setting Serial Data for Expansion ... 39**

B.1	Setting Serial Data for Expansion.....	40
B.2	Touch screen RS232 Connector Pin Definition .....	41

# Chapter 1

## General Information

Sections include:

- Introduction
- Specifications
- LCD Specification
- Power Consumption
- Connectors
- Dimensions

---

## 1.1 Introduction

Advantech's FPM-3000G is a 12"/15"/17"/19" color TFT LED flat panel monitor built specifically for industrial applications. With the optional touchscreen, FPM-3000 is an excellent and user-friendly system control interface.

In addition to its usual application as an LCD panel monitor, FPM-3000G comes standard with direct VGA/DVI signal inputs, making it compatible with Industrial PCs and Workstations. Its OSD (On front panel) function allows you to adjust display factors such as brightness, contrast, colours and VGA signal information. Functions that are more and more critical as HMI users become aware of the benefits of flat panel monitors. The rear cover is of SECC steel, and the front panel is of die-cast magnesium alloy with IP65 certification.

With a new system design, this monitor can support operating temperatures from -20 ~ 60°C for a variety of environments. Designed with various mounting methods for users to apply into the system or adopt to the environment easily.

## 1.2 Specifications

### 1.2.1 General

- **Construction:** Aluminum front panel with hard anodized coating rear cover
- **Front panel:** IP65 certified
- **Control:** Lockable OSD control pad on front side
- **Mounting:** Panel, wall, desktop, VESA
- **Dimensions (W x H x D):**
  - FPM-3121G: 312 x 244 x 60 mm
  - FPM-3151G: 422 x 310 x 70 mm
  - FPM-3171G: 482 x 354.8 x 63.5 mm
  - FPM-3191G: 482 x 399.2 x 67 mm
- **Weight:**
  - FPM-3121G: 4.07 kg
  - FPM-3151G: 7.73 kg
  - FPM-3171G: 9.25 kg
  - FPM-3191G: 10.65 kg

### 1.2.2 Touchscreen

- **Type:** 5-wire Resistive Touch
- **Controller:** USB & RS-232 (Combo)
- **OS Support:** Windows XP,Vista,7,8,XPe,CE, 10 and Linux

## 1.3 LCD Specifications

### FPM-3121G

- **Display Type:** XGA TFT LCD
- **Display Size:** 12.1"
- **Max. Colors:** 16.2M
- **Max. Resolution:** 1024 x 768
- **Viewing Angle:** 140(V), 160(H)
- **Luminance:** 600 cd/m<sup>2</sup>
- **Storage Temperature:** -40 ~ 85°C
- **Operating Temperature:** -30 ~ 80°C
- **Safety Operation Temperature:** -20 ~ 60°C
- **Contrast Ratio:** 700:1 (typical)
- **Lamp Life Time (MTBF):** 50,000 hrs.

### FPM-3151G

- **Display Type:** XGA TFT LCD
- **Display Size:** 15"
- **Max. Colors:** 16.2 M
- **Max. Resolution:** 1024 x 768
- **Viewing Angle:** 140(V), 160(H)
- **Luminance:** 400 cd/m<sup>2</sup>
- **Storage Temperature:** -40 ~ 85°C
- **Operating Temperature:** -30 ~ 80°C
- **Safety Operation Temperature:** -20 ~ 60°C
- **Contrast Ratio:** 700:1 (typical)
- **Lamp Life Time (MTBF):** 50,000 hrs.

### FPM-3171G

- **Display Type:** SXGA TFT LCD
- **Display Size:** 17"
- **Max. Colors:** 16.7 M
- **Max. Resolution:** 1280 x 1024
- **Viewing Angle:** 140(V), 160(H)
- **Luminance:** 350 cd/m<sup>2</sup>
- **Storage Temperature:** -30 ~ 85°C
- **Operating Temperature:** -30 ~ 85°C
- **Safety Operation Temperature:** -20 ~ 60°C
- **Contrast Ratio:** 800:1 (typical)
- **Lamp Life Time (MTBF):** 50,000 hrs.

## FPM-3191G

- **Display Type:** SXGA TFT LCD
- **Display Size:** 19"
- **Max. Colors:** 16.7 M
- **Max. Resolution:** 1280 x 1024
- **Viewing Angle:** 160(V), 170(H)
- **Luminance:** 350 cd/m<sup>2</sup>
- **Storage Temperature:** -30 ~ 85°C
- **Operating Temperature:** -30 ~ 85°C
- **Safety Operation Temperature:** -20 ~ 60°C
- **Contrast Ratio:** 1000:1 (typical)
- **Lamp Life Time (MTBF):** 50,000 hrs.

**Note!** *There might be several bright or dark pixels on the LCD. This phenomenon is normal in today's LCD manufacturing. Inspection criteria are following specifications defined by LCD vendor.*



**Note!** *Section 1.3 specifications are for LCD only.*



*Please refer to system specification for operating & storage temperatures*

## 1.4 Power Consumption

- **Max Power consumption:**
  - FPM-3121G: 15 W ± 20%
  - FPM-3151G: 12 W ± 20%
  - FPM-3171G: 23 W ± 20%
  - FPM-3191G: 18 W ± 20%
- **Power input:** Phoenix Jack: 24 VDC ± 20%
- **Safety Standards:** BSMI, CE, FCC, CCC, UL

## 1.5 Connectors

The following connectors are situated on FPM-3000T Series:

- **VGA Port (DB-15)**

This DB-15 connector can be connected to the system via the external 15-pin DB-15 connector located on the left side of the system unit.
- **DVI-D port**

Connected with a standard DVI connector thru I/O port of this unit. Only supports digital signals.
- **Touchscreen Connector (DB-9)**

This connector will be present only if a touchscreen is installed. It must be connected to the RS-232 port of the PC. The touchscreen cable is included with all orders which include the touchscreen option.

- **Touchscreen Connector (USB)**

This connector will be present only if a touchscreen is installed. It must be connected to the USB port of the PC. The touchscreen cable is included with all orders which include the USB touchscreen option.

**Note!** *RS-232 & USB touchscreen interface allow connection into the system at the same time, but USB interface has higher priority. Also be noted that when using USB touch interface and switch to RS-232 interface, it need to restart your industrial PCs or workstation.*



- **Plug-In Block 3P Male (ME050-50803) DC 24 V**

This block connector can be connected via the external plug-in block 3P with flanges Female MC211-F103 connector.

- For supply connections, use wires suitable for at least 75°C.

# 1.6 Dimensions

FPM-3121G Panel Cut-out Dimensions: 303.5 x 229.5 mm (11.95" x 9.04")

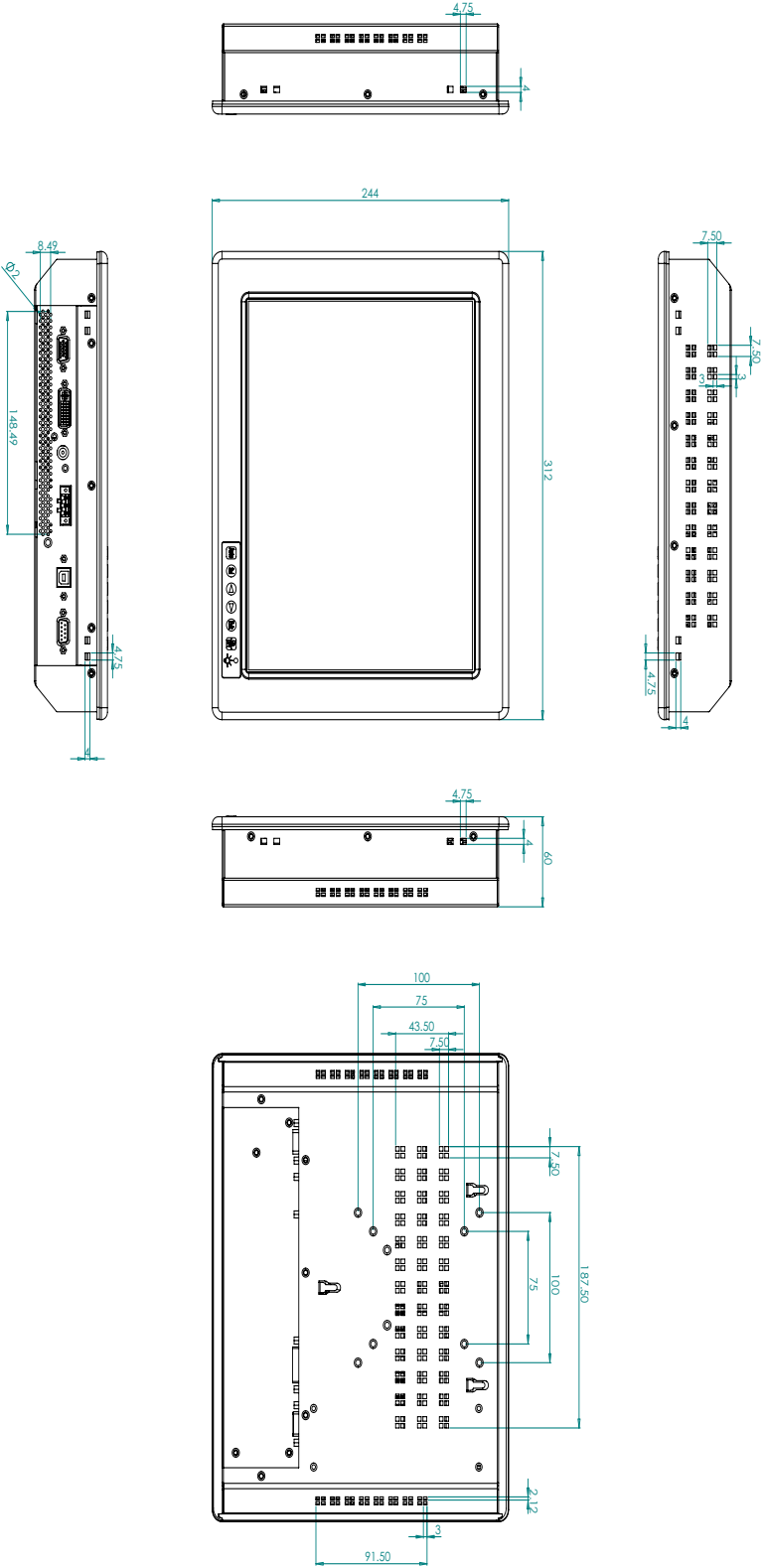
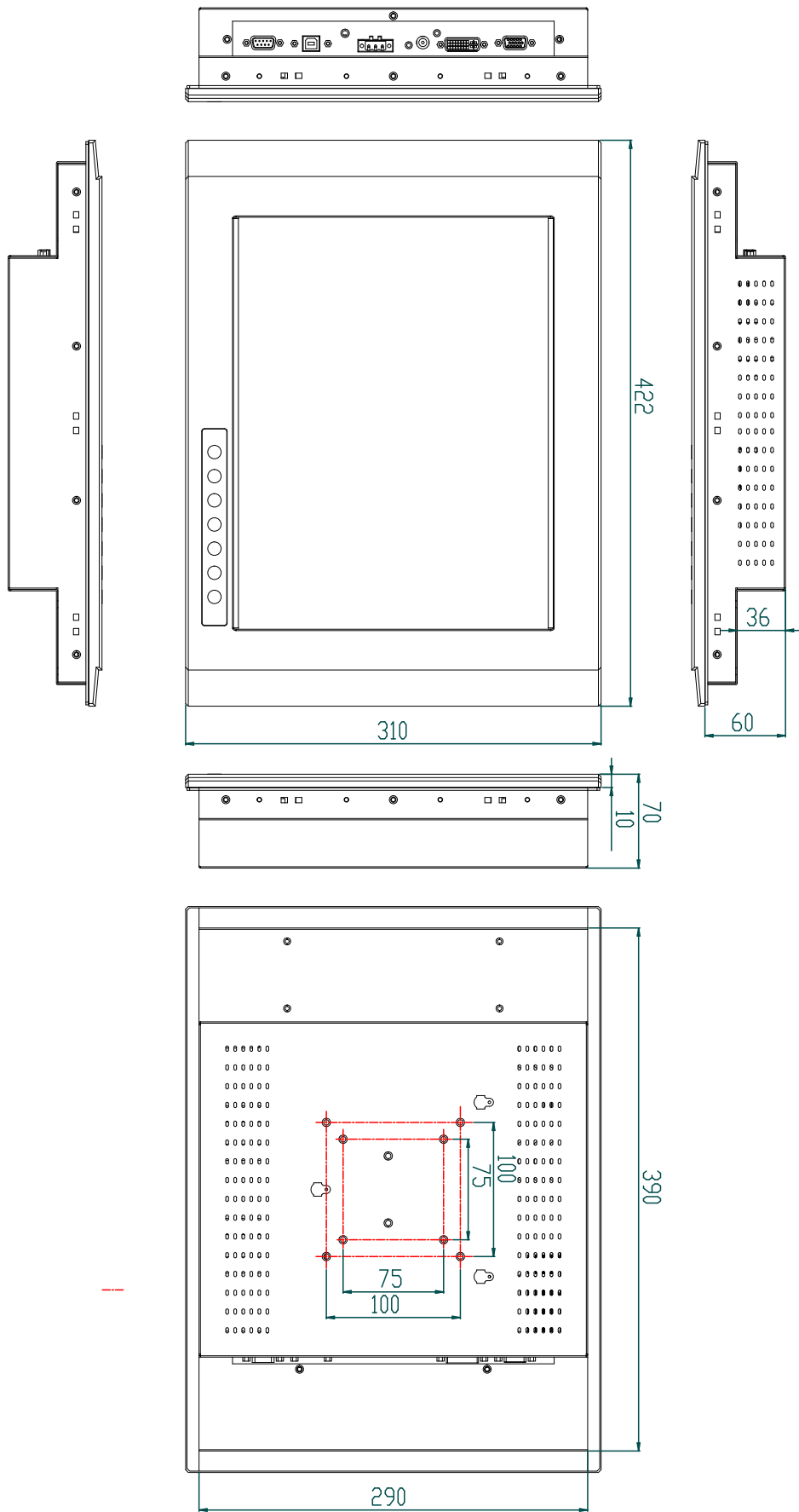

Figure 1.1 FPM-3121G Dimensions





FPM-3151G Panel Cut-out Dimensions:392 x 292 mm (15.43" x 11.49")

Figure 1.2 FPM-3151G Dimensions

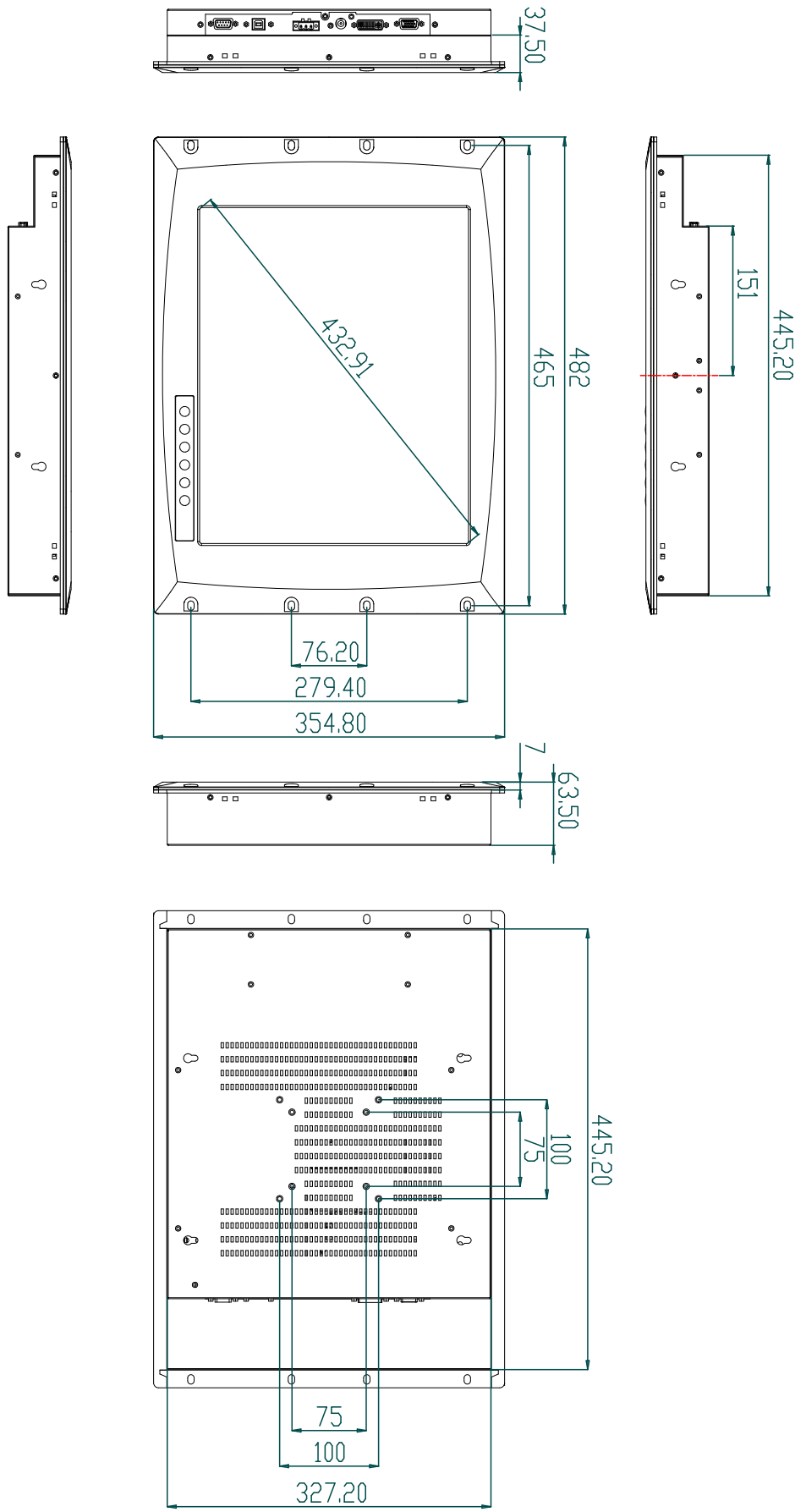

FPM-3171G Panel Cut-out Dimensions: 447.2 x 329.2 mm (17.6" x 12.96")

Figure 1.3 FPM-3171G Dimensions

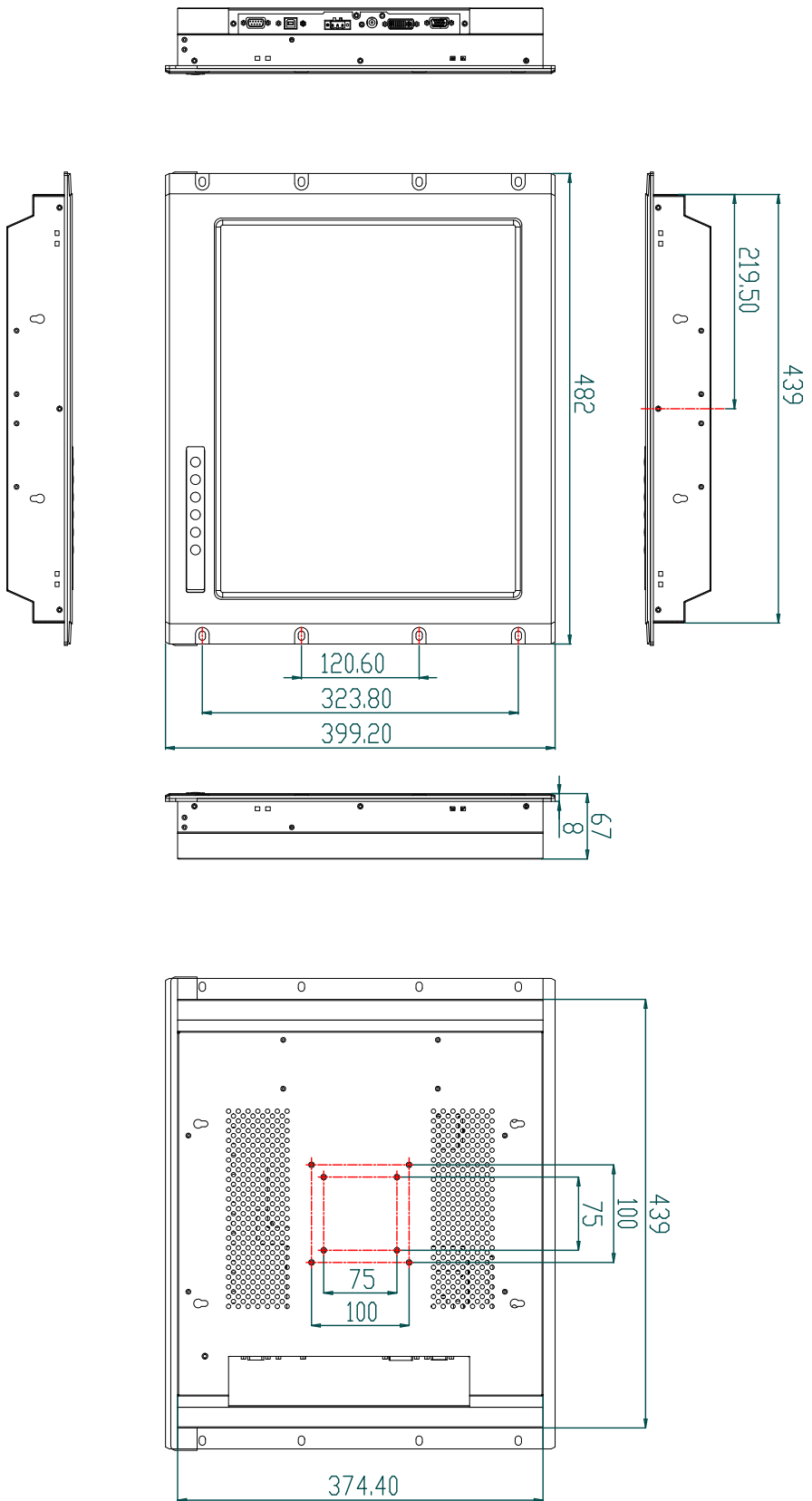

FPM-3191G Panel Cut-out Dimensions: 441 x 376.4 mm (17.36" x 14.81")

Figure 1.4 FPM-3191G Dimensions

## 1.7 IO View

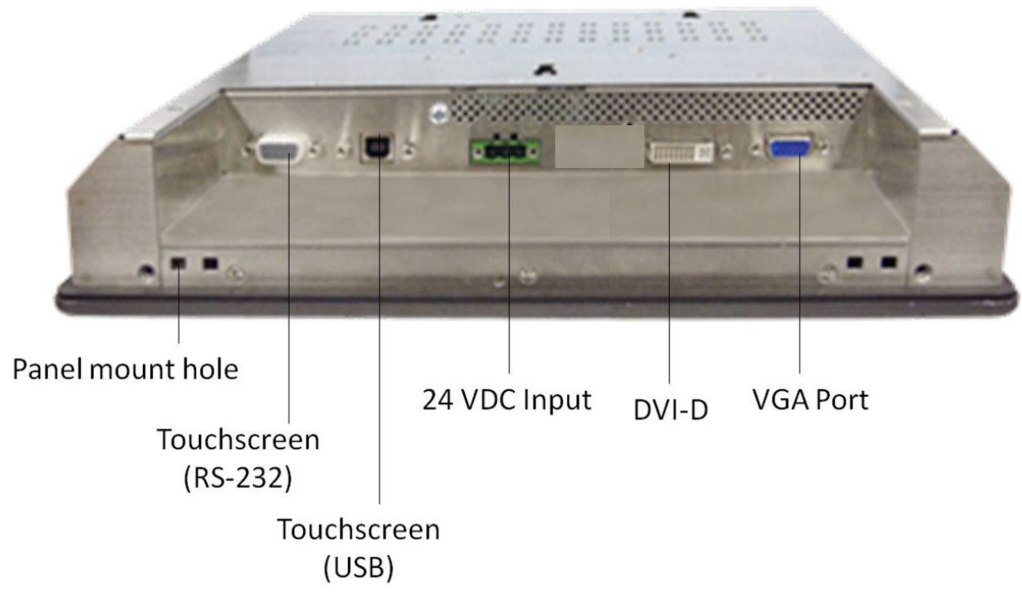

# Chapter 2

## Mounting

- Wall Mounting
- Panel Mounting
- Desktop Mounting
- Swing Arm Mounting

## 2.1 Mounting the Monitor

The FPM-3000G Series can be mounted in many different ways. The versatility of the FPM-3000G enable it to be mounted on your desk or anywhere else.

### 2.1.1 Wall Mounting with FPM-1000T-SMKE

The FPM-3000G can be mounted directly on a wall with panel mounting brackets. Please refer to Figure 2.1 and follow the following steps to mount FPM-3000G on a wall:

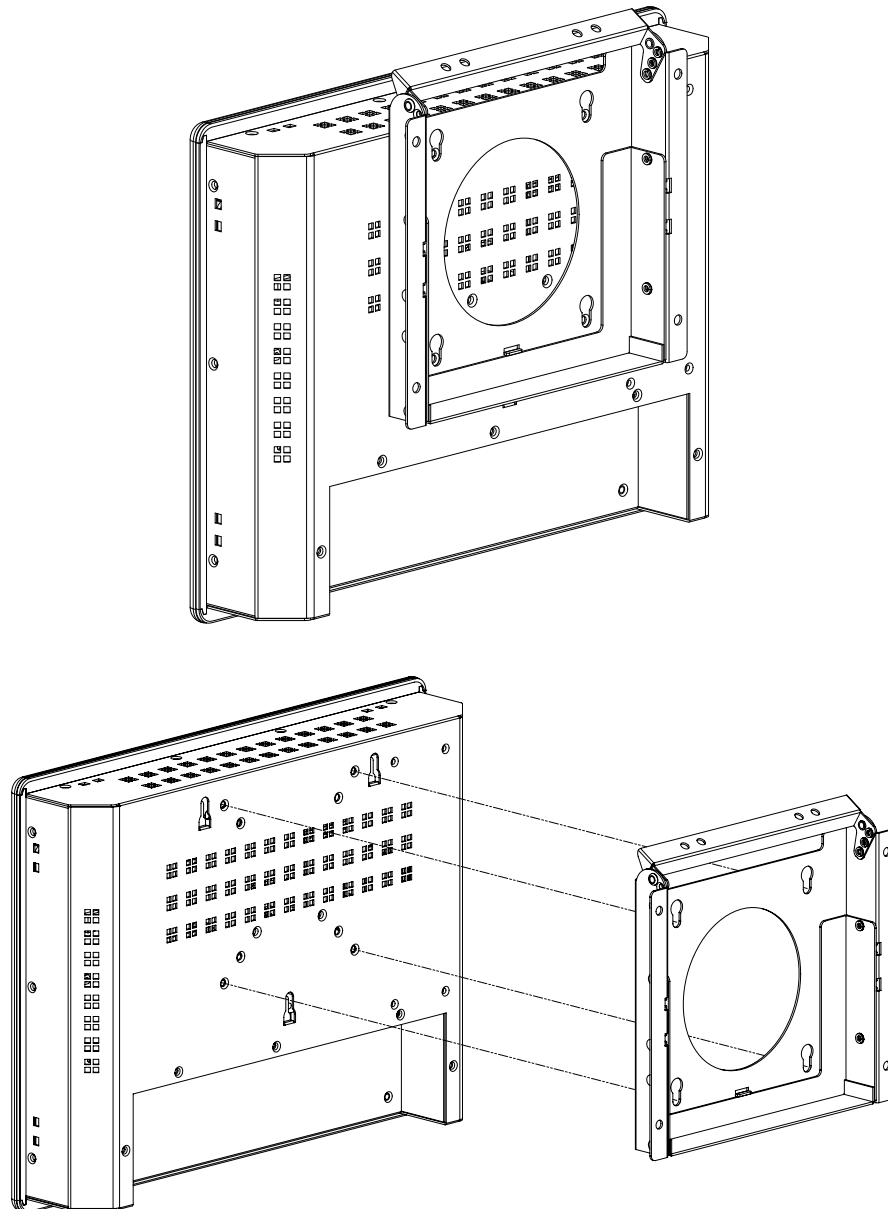
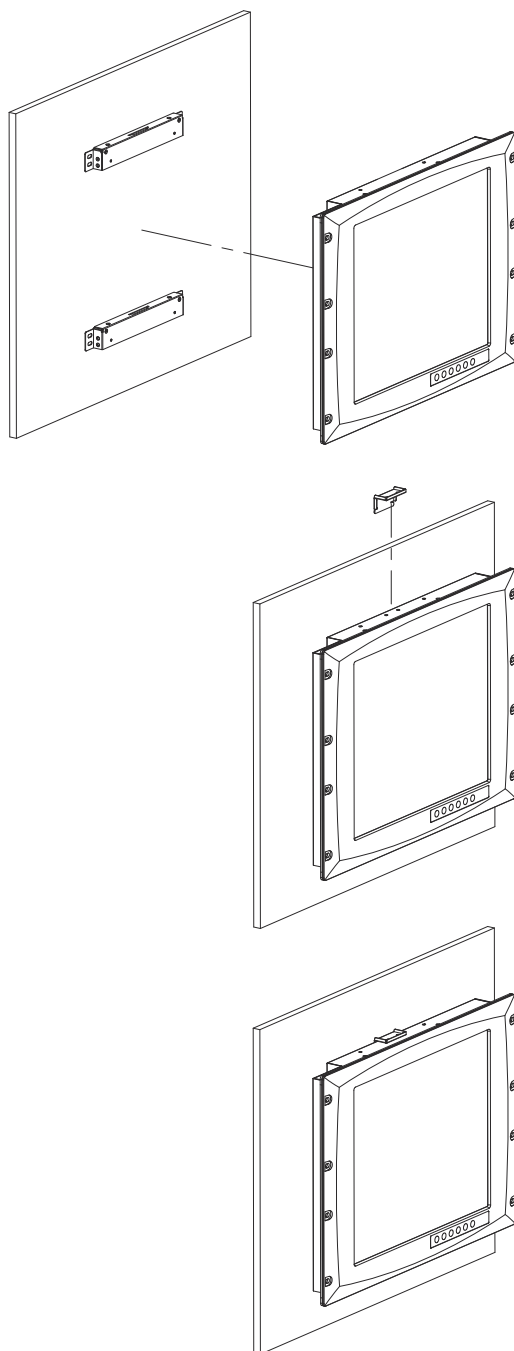

Figure 2.1 Wall Mounting for FPM-3121G/3151G

### Wall Mounting for FPM-3171G/3191G

With wall brackets, the FPM-3171G/3191G can be mounted directly to a wall. If you need to install the FPM-3171G/3191G in different ways, release the mounting brackets by detaching the four screws on the rear side.



**Figure 2.2 Wall Mounting for FPM-3171G/3191G**

## 2.1.2 Panel Mounting

If you need to install the FPM-3000G series in a panel, release the mounting brackets by detaching four screws on rear side and fix them on the top and bottom with screws.

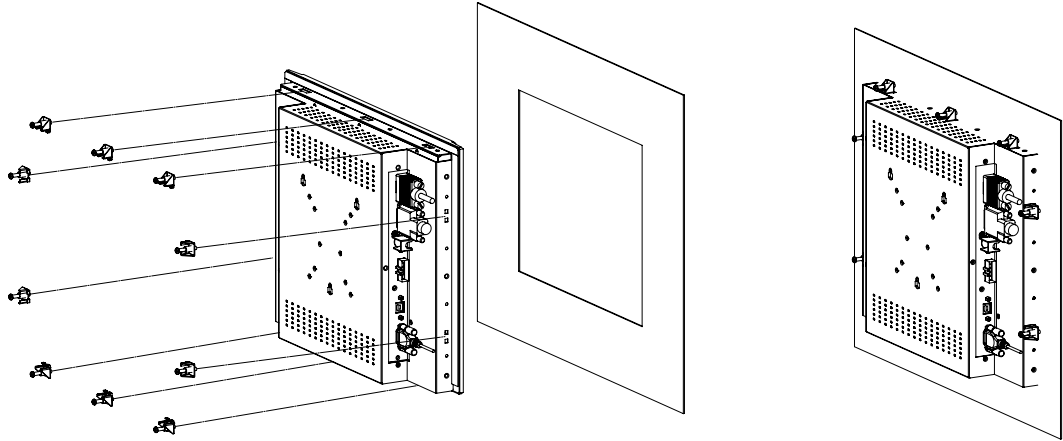

Figure 2.3 Panel Mounting (392 x 292 mm)



### Panel Mounting FPM-3171G

If you need to install the FPM-3171 series on a panel mount, release the mounting brackets by detaching four screws on rear side and fix them on up and bottom side by screws.

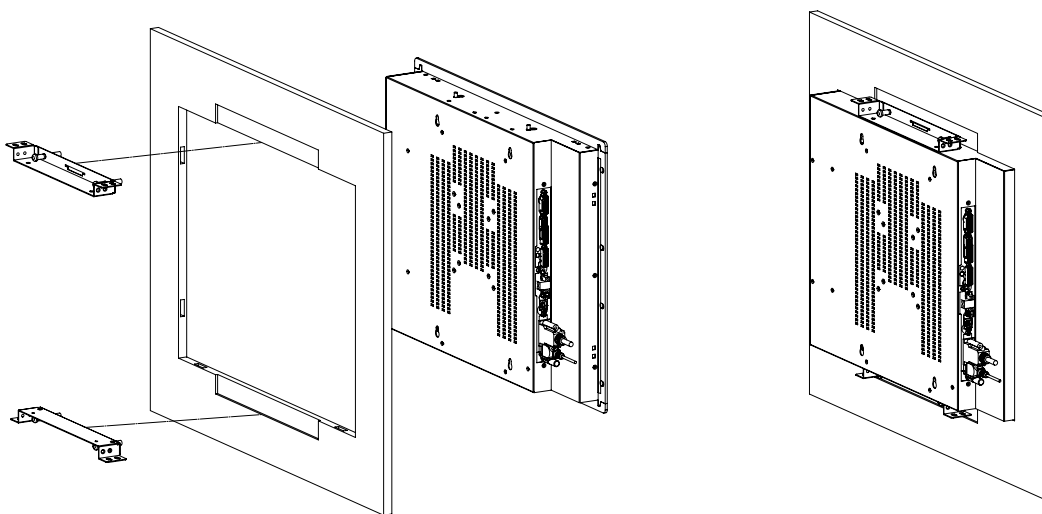

Figure 2.4 Panel Mounting (447.2 x 329.2mm)

### Panel Mounting FPM-3191G

If you need to install the FPM-3191 series on a panel mount, release the mounting brackets by detaching four screws on rear side and fix them on up and bottom side by screws.

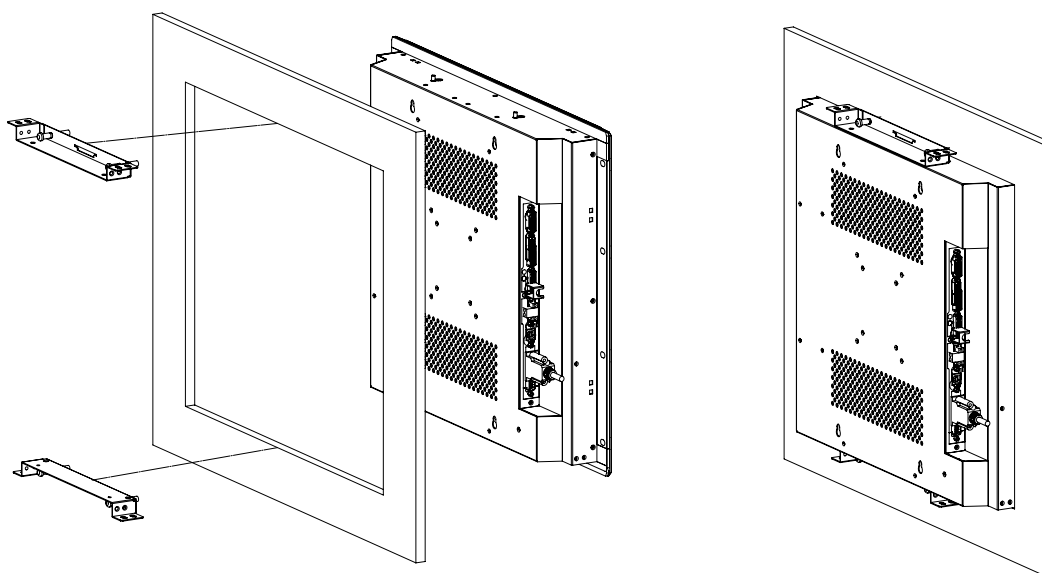

Figure 2.5 Panel Mounting (441 x 376.4mm)

---

## 2.1.3 VESA Mount for FPM-3000G

### 2.1.3.1 Desk top stand with FPM-1000T-SMKE Kit

The FPM-3000G can be mounted as a stand on the desk by additional mounting brackets. See figure 2.6 below for reference.

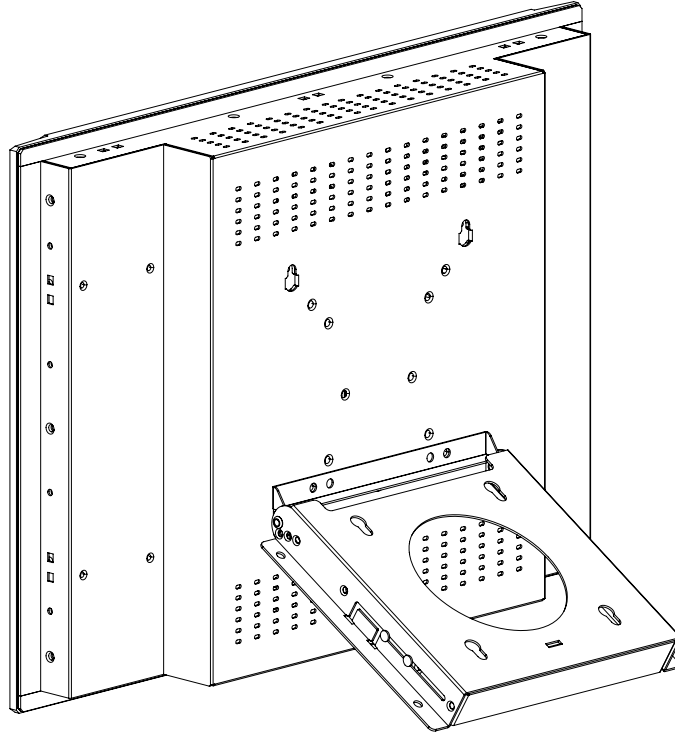

**Figure 2.6 Desktop Stand for FPM-3121G/3151G**

The desktop stand brackets are attached to the rear of FPM-3171.

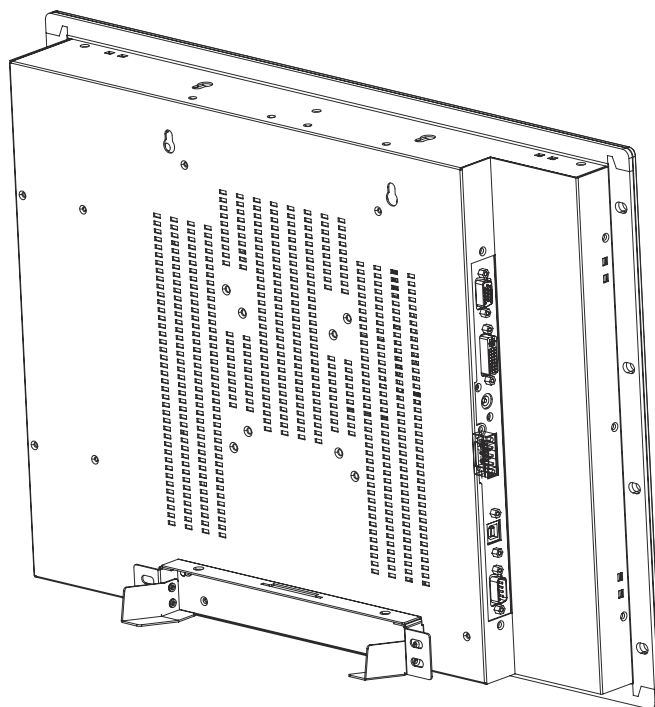

**Figure 2.7 Desktop Stand for FPM-3171G**

The desktop stand brackets are attached to the rear of FPM-3191.

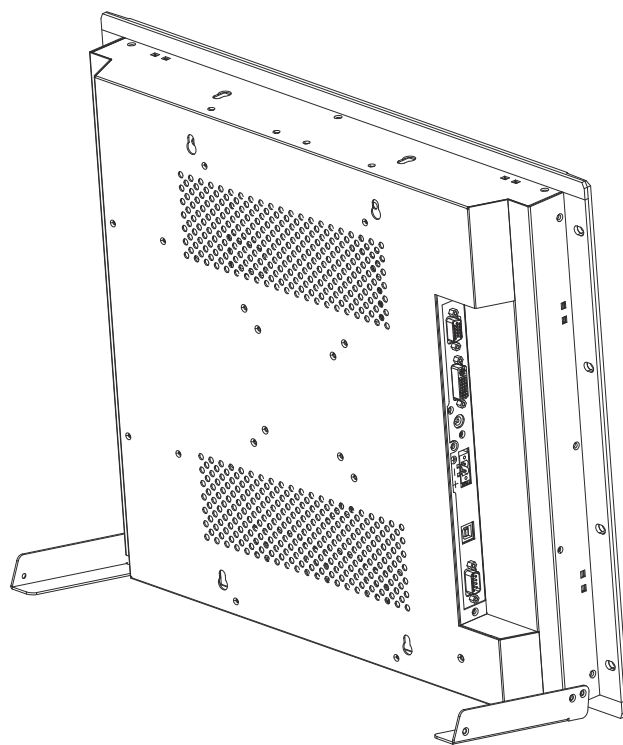

**Figure 2.8 Desktop Stand for FPM-3191G**

### 2.1.3.2 VESA Mount

FPM-3000G has been designed with support for the VESA mount standard. Refer to figure 2.9 ~ 2.12 all FPM-3000 support both VESA 75 x 75 mm & 100 x100 mm.

**Warning!** Use suitable mounting apparatus to avoid risk of injury.



**ATTENTION:** Veuillez utiliser un système de montage approprié afin d'éviter tout risque de blessure.

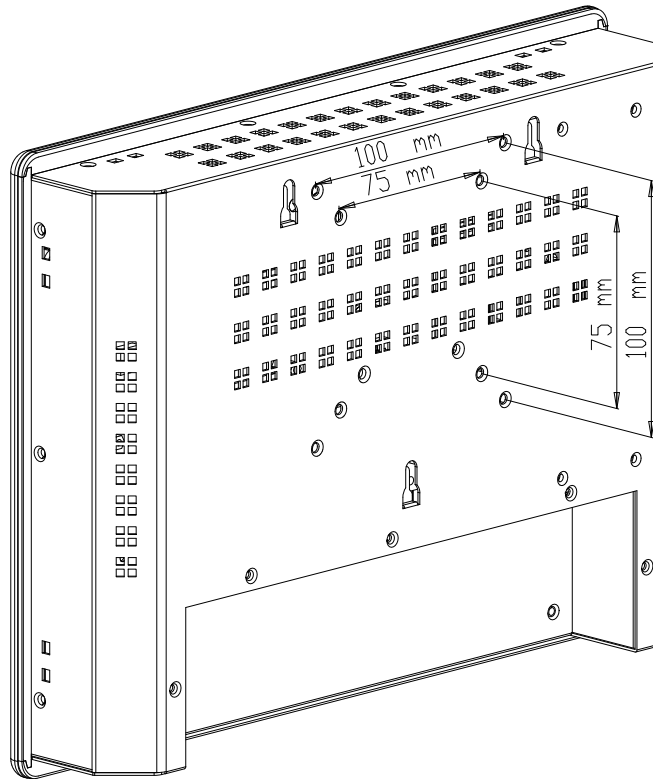

**Figure 2.9 VESA mount for FPM-3121G**

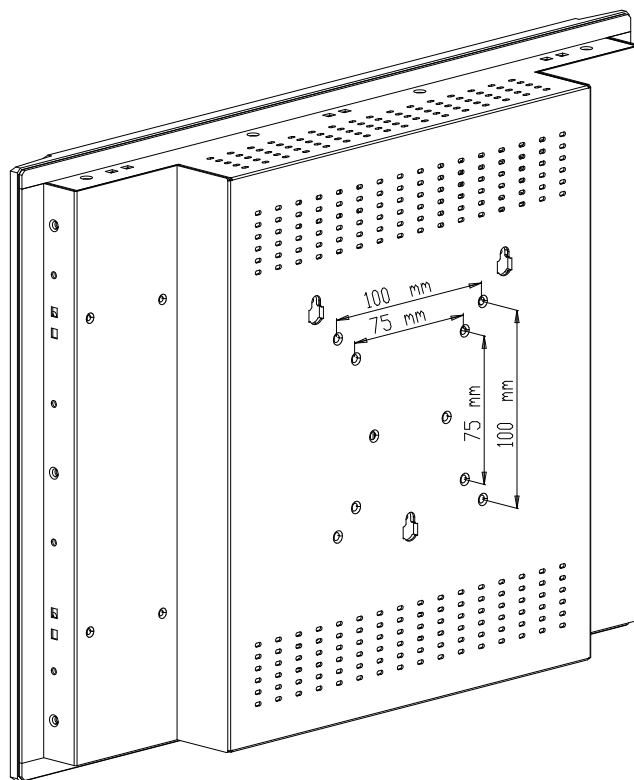

**Figure 2.10 VESA mount for FPM-3151G**

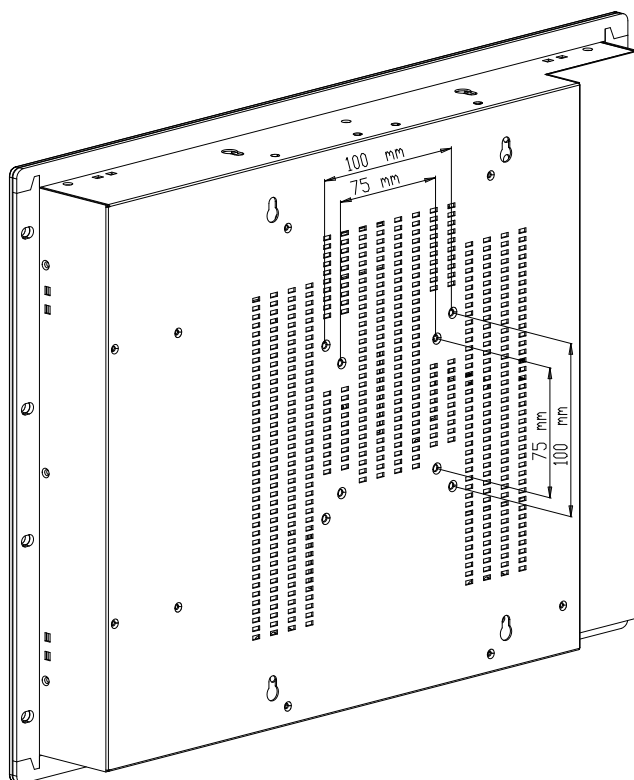

**Figure 2.11 VESA mount for FPM-3171G**

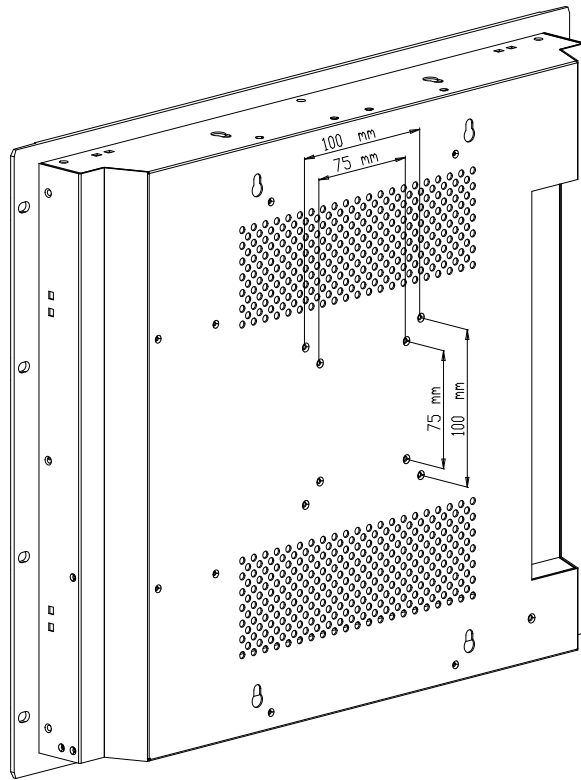

**Figure 2.12 VESA mount for FPM-3191G**

## 2.1.4 Rack Mounting

The FPM-3171G and FPM-3191G products can be directly mounted in an industrial standard 19" rack. There are four screw holes on each side of the panel.

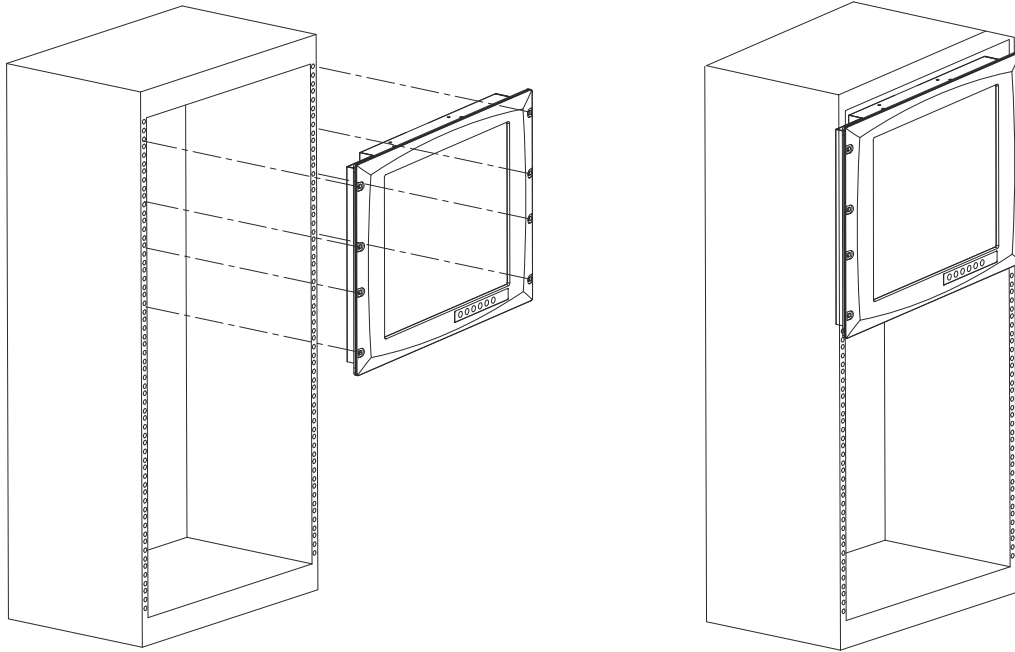

**Figure 2.13 Rack Mounting for FPM-3171G/FPM-3191G**





# Appendix **A**

OSD Operation  
Keypad

## A.1 OSD Board Overview (FPM-31xxG)

The OSD keypad, including six keys and a two color indicator, is designed as the OSD operation interface.



### A.1.1 OSD Button Description

Buttons	Descriptions
Power	Turn the monitor power ON or OFF.
Auto/Exit	Automatically adjust the clock, phase, H-position and V-position. Exit menu.
Down/Right/ Increase	Activate the volume control. Move the selector to the next option. Increase the gauge value of the selected option. Increases brightness
Up/Left/ Decrease	Active volume control. Move the selector to the previous option. Decrease the gauge value of the selected option. Decreases brightness
Menu/Sel	Activate the OSD menu. Enter/confirm the selected option.
Source	Changes Input video source

### A.1.2 LED Functions

On	Green
StandBy/Off	Green Blinking
No Signals	Orange

## A.2 OSD Key Functions

Each selected value is stored into LCD memory after SEL signal input or time out. The stored values are not affected if the power is turned off. But the selected value is not available in case a selected mode is changed before time out or power is turned off before time out. TIME OUT .. 5-6 seconds ( Can be set in OSD Manager) The default definition of input keys is shown as following:

### A.2.1 Menu Start

Generate Main Menu

Press MENU Button in OSD function key

- Main Menu

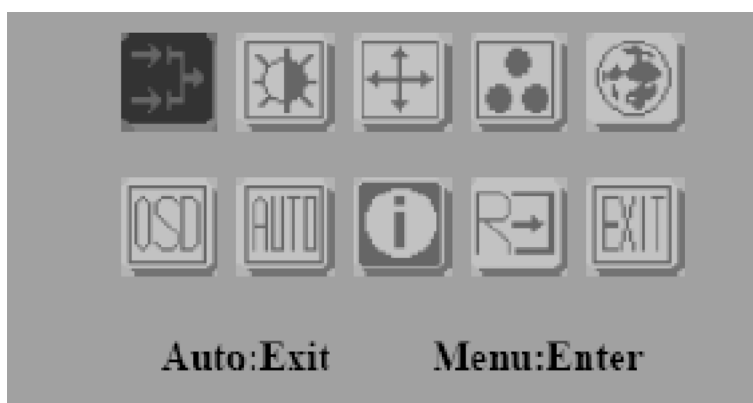

- Sub-Menu – DISPLAY IN SCREEN
- Available Key Functions

	N/A		N/A
	Select to exit menu or wait for timeout		N/A
	N/A		N/A

## A.2.2 Input Source Select

- Generate Main Menu

Select  by **Left** and **Right** Button, press **Menu** Button for selection confirmation.

- Main Menu -- DISPLAY IN SCREEN



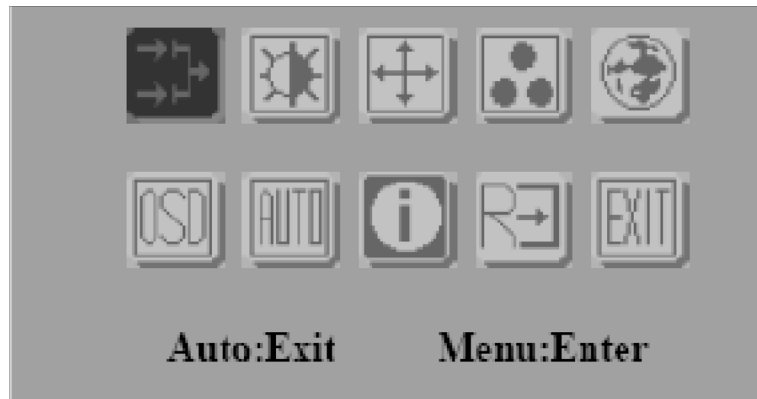

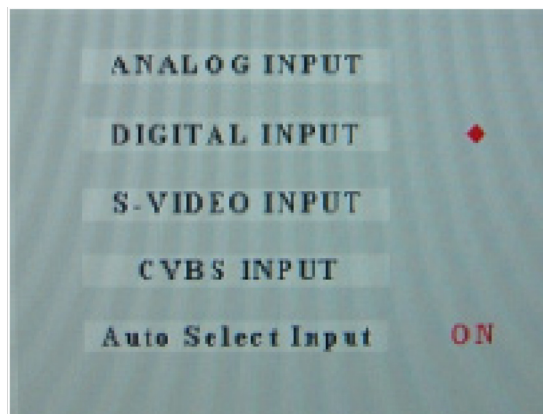

0



- Sub-Menu – DISPLAY IN SCREEN



- Available Key Functions

	Power Off the LCD Monitor		Decrease the gauge value of the selected option.
	Return to last menu		Select to confirm
	Increase the gauge value of the selected option.		N/A

### Auto Select Input

- **ON**> start from default setting and scan the inputs by following sequence from ANALOG INPUT, DIGITAL INPUT, S-VIDEO INPUT, and CVBS INPUT.
- **OFF**>. start from default setting

### A.2.3 Contrast/ Brightness Setting

- Generate Main Menu

Select  by **Left** and **Right** Button, press **Menu** Button for selection confirmation.



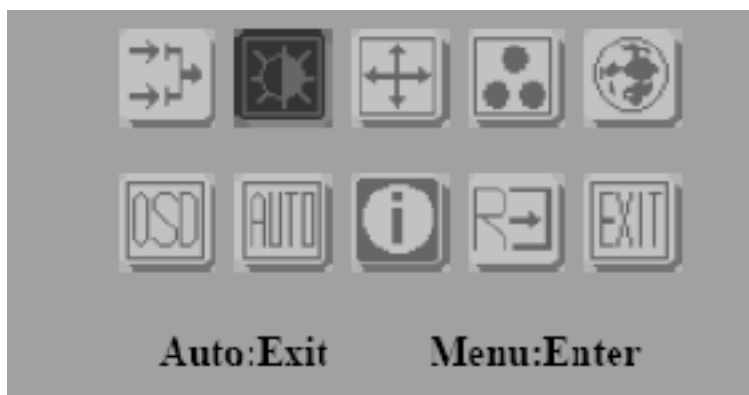

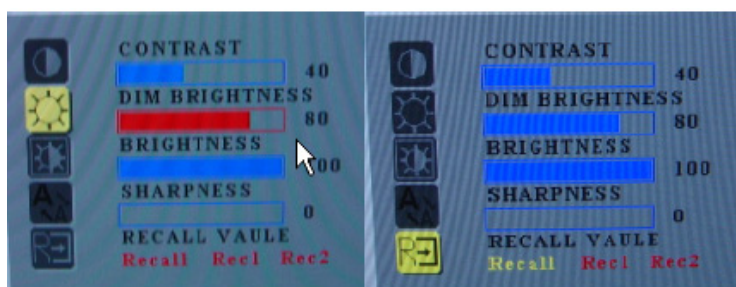

- Main Menu -- DISPLAY IN SCREEN



- Sub-Menu – DISPLAY IN SCREEN



- Available Key Functions

	Power Off the LCD Monitor		Decrease the gauge value of the selected option.
	Return to last menu		Select to confirm
	Increase the gauge value of the selected option.		N/A

#### RECALL VALUE – User Define

- **Rec1**> Pressed to record 1st setting as recall value followed by current screen setting
- **Rec2**> Pressed to record 2nd setting as recall value followed by current screen setting
- **Recall**> Switch the setting change by Rec1 and Rec2 while pressed

## A.2.4 Geometry Menu – For DVI Input

- Generate Main Menu

Select  by **Left** and **Right** Button, press **Menu** Button for selection confirmation.



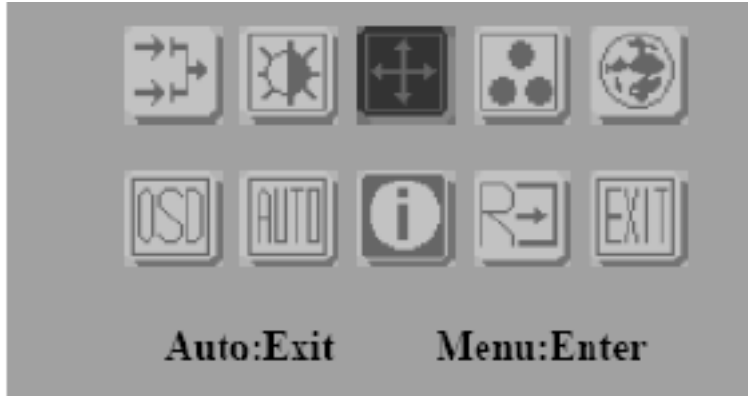

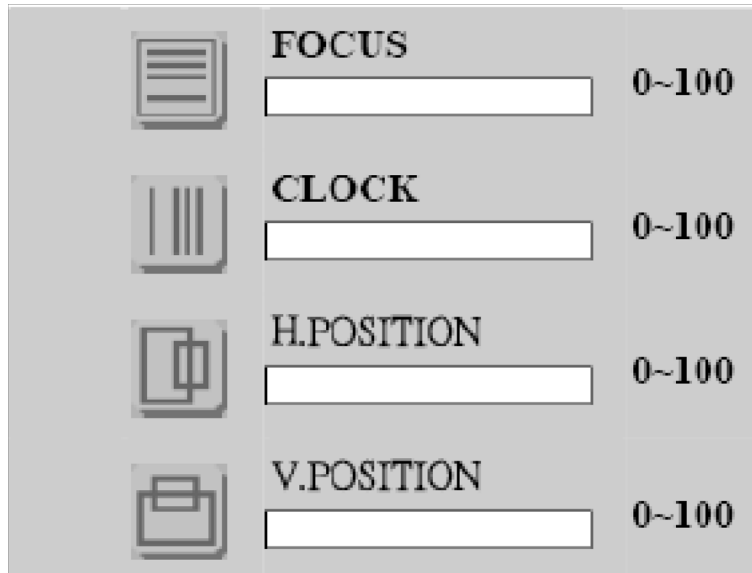

- Main Menu -- DISPLAY IN SCREEN



- Sub-Menu – DISPLAY IN SCREEN



- Available Key Functions

	Power Off the LCD Monitor		Decrease the gauge value of the selected option.
	Return to last menu		Select to confirm
	Increase the gauge value of the selected option.		N/A

## A.2.5 Color Temperature Menu

- Generate Main Menu

Select  by **Left** and **Right** Button, press **Menu** Button for selection confirmation.



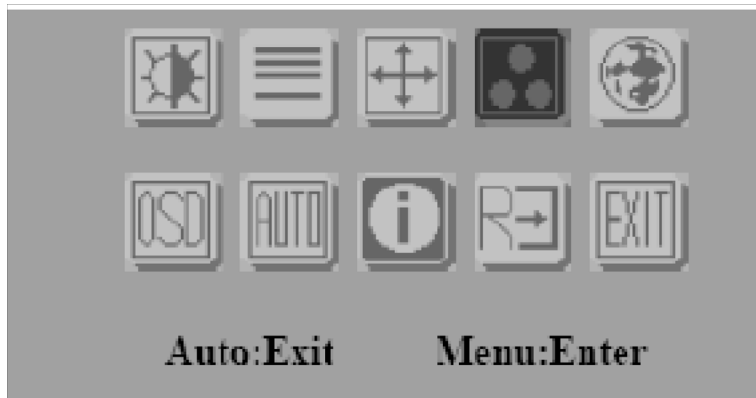

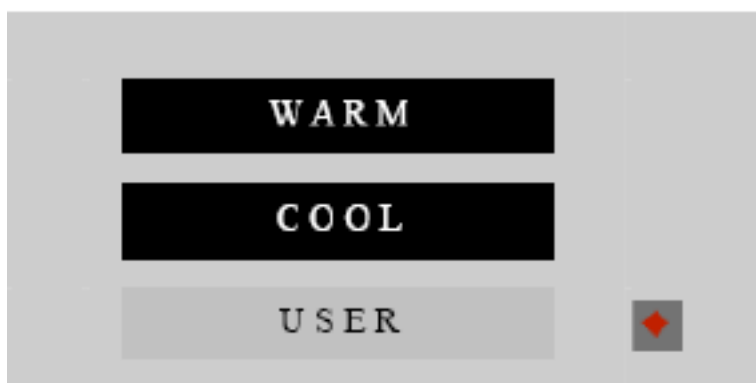

- Main Menu -- DISPLAY IN SCREEN



- Sub-Menu – DISPLAY IN SCREEN



- Available Key Functions

	Power Off the LCD Monitor		Decrease the gauge value of the selected option.
	Return to last menu		Select to confirm
	Increase the gauge value of the selected option.		N/A

## A.2.6 RGB Color Menu

- Generate Main Menu

Select  by **Left** and **Right** Button, press **Menu** Button for selection confirmation.

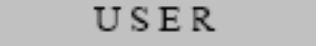
Select  by **Left** and **Right** Button, Press **Menu** Button for selection confirmation.

- Main Menu -- DISPLAY IN SCREEN

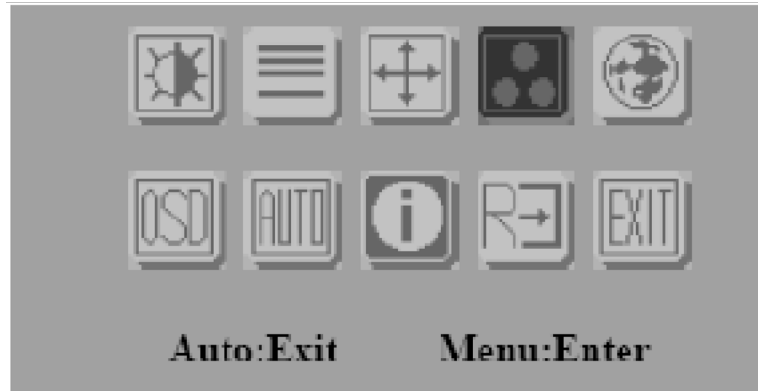

- Sub-Menu – DISPLAY IN SCREEN

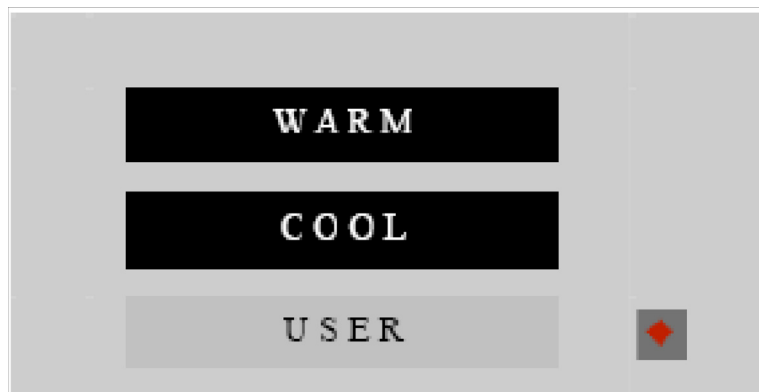



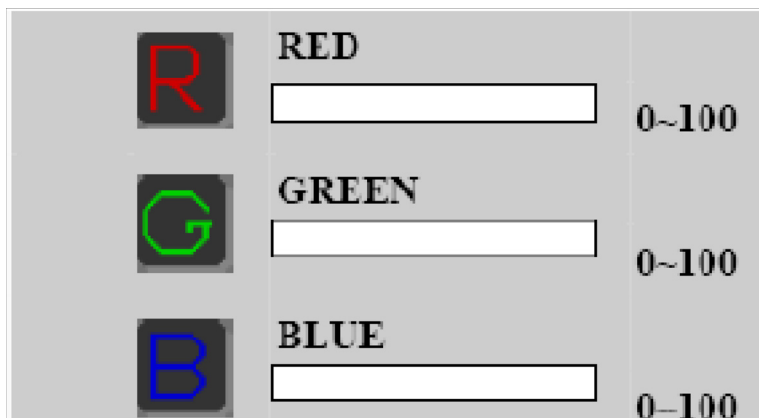



- Sub-Menu – DISPLAY IN SCREEN





### ■ Available Key Functions

	Power Off the LCD Monitor		Decrease the gauge value of the selected option.
	Return to last menu		Select to confirm
	Increase the gauge value of the selected option.		N/A

Customization setting for RGB colors

## A.2.7 Language Menu

- Generate Main Menu

Select  by **Left** and **Right** Button, press **Menu** Button for selection confirmation.



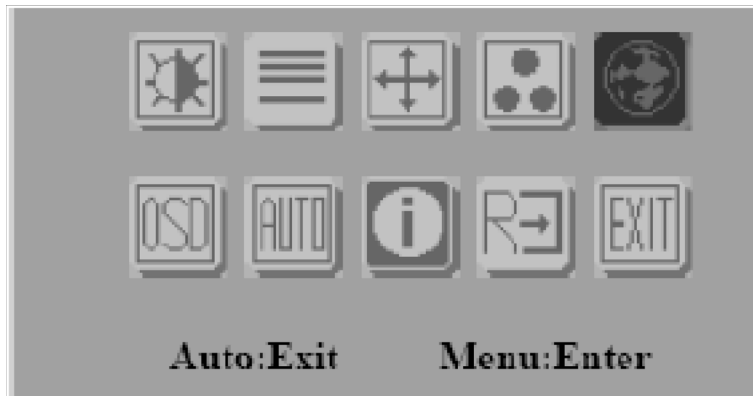



- Main Menu -- DISPLAY IN SCREEN



- Sub-Menu – DISPLAY IN SCREEN



- Available Key Functions

	Power Off the LCD Monitor		Decrease the gauge value of the selected option.
	Return to last menu		Select to confirm
	Increase the gauge value of the selected option.		N/A

## A.2.8 OSD Manager

- Generate Main Menu

Select  by **Left** and **Right** Button, press **Menu** Button for selection confirmation.

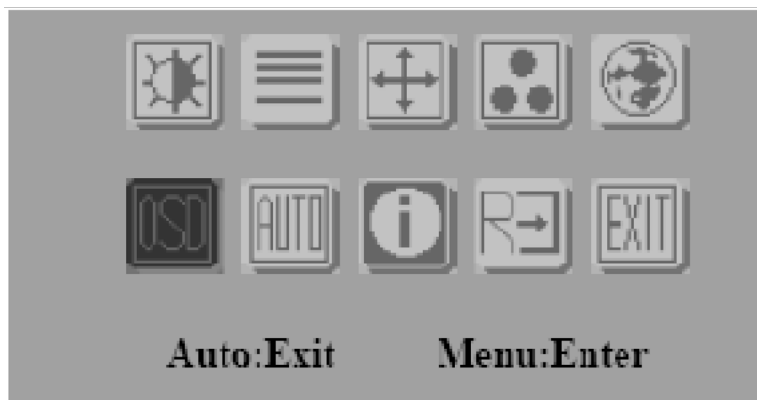

- Main Menu -- DISPLAY IN SCREEN

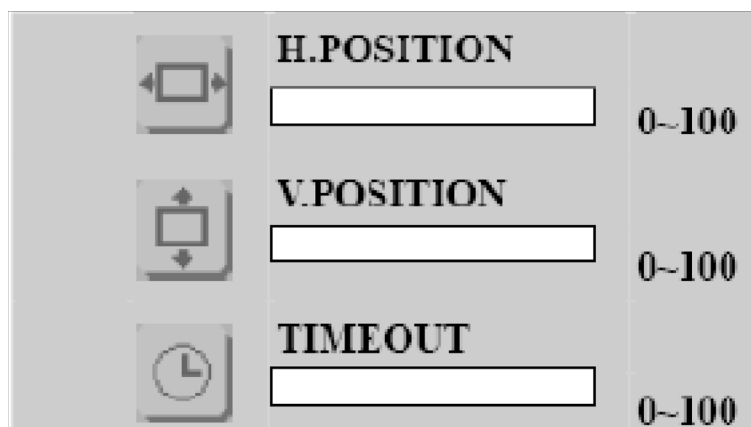

- Sub-Menu – DISPLAY IN SCREEN



- Available Key Functions

	Power Off the LCD Monitor		Decrease the gauge value of the selected option.
	Return to last menu		Select to confirm
	Increase the gauge value of the selected option.		N/A

## A.2.9 Auto Configuration Menu

Select  by **Left** and **Right** Button, press **Menu** Button for selection confirmation.



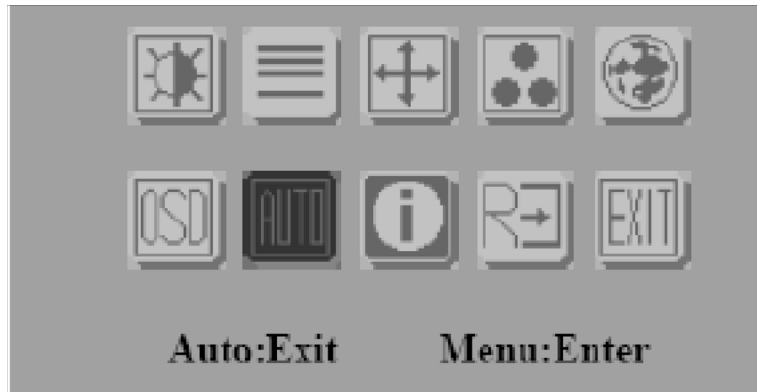



- Main Menu -- DISPLAY IN SCREEN



- Sub-Menu – DISPLAY IN SCREEN



- Available Key Functions

	Power Off the LCD Monitor		Decrease the gauge value of the selected option.
	Return to last menu		Select to confirm
	Increase the gauge value of the selected option.		N/A

Auto configuration can be set in menu and also can press the  without any menu indication.

## A.2.10 Mode Information Menu

- Generate Main Menu

Select  by **Left** and **Right** Button, press **Menu** Button for selection confirmation.



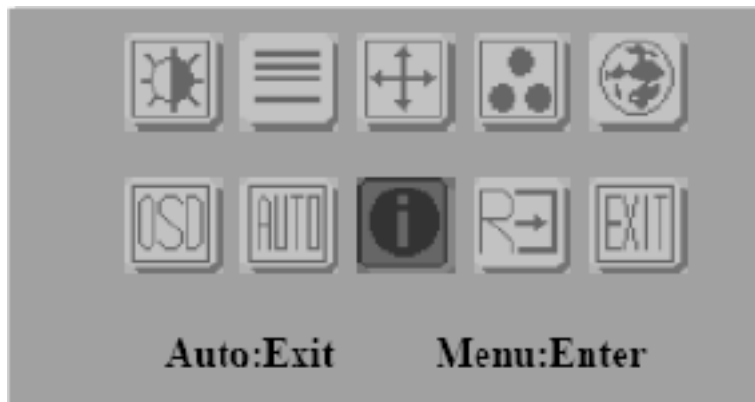

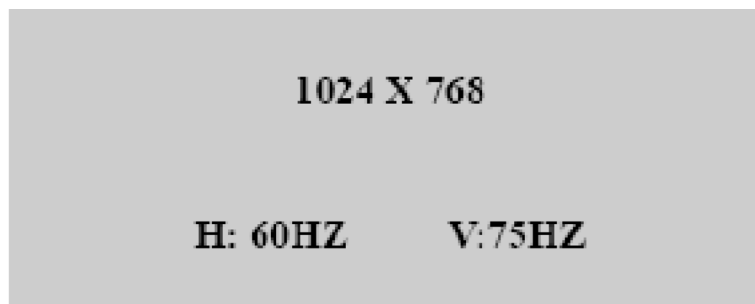

- Main Menu -- DISPLAY IN SCREEN



- Sub-Menu – DISPLAY IN SCREEN



- Available Key Functions

	Power Off the LCD Monitor		Decrease the gauge value of the selected option.
	Return to last menu		Select to confirm
	Increase the gauge value of the selected option.		N/A

## A.2.11 Memory Recall Menu

- Generate Main Menu

Select  by **Left** and **Right** Button, press **Menu** Button for selection confirmation.



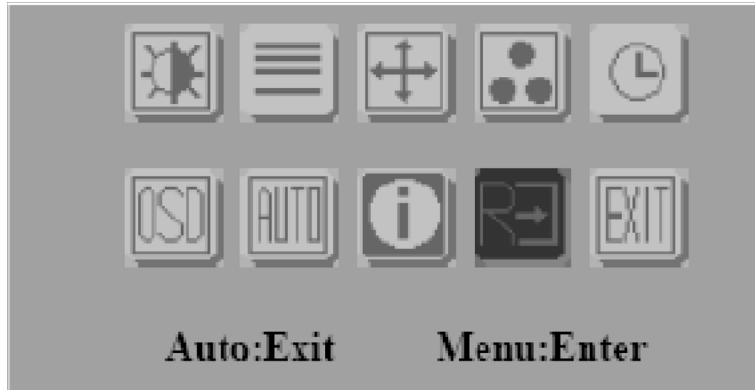

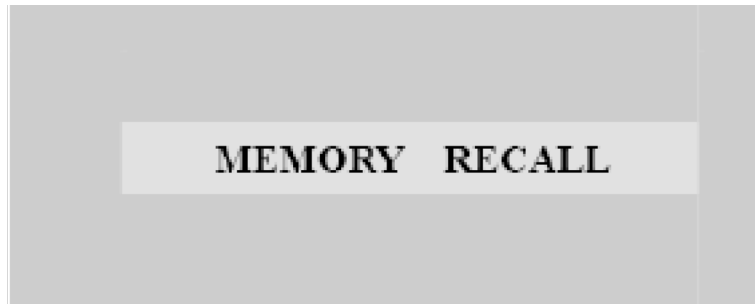

- Main Menu -- DISPLAY IN SCREEN



- Sub-Menu – DISPLAY IN SCREEN



- Available Key Functions

	Power Off the LCD Monitor		Decrease the gauge value of the selected option.
	Return to last menu		Select to confirm
	Increase the gauge value of the selected option.		N/A

## A.2.12 Exit Menu

- Generate Main Menu

Select  by **Left** and **Right** Button, press **Menu** Button for selection confirmation.



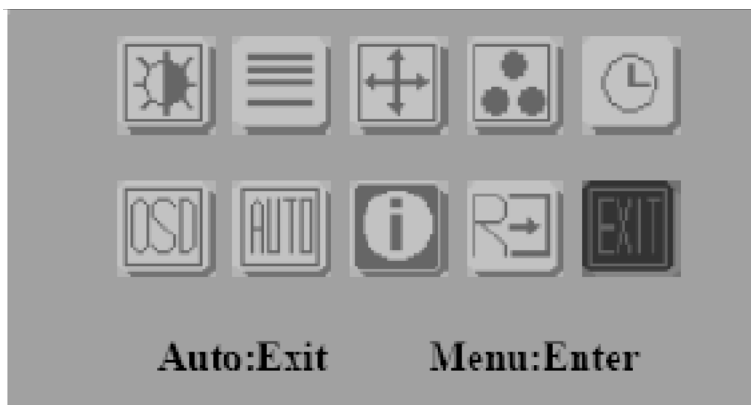

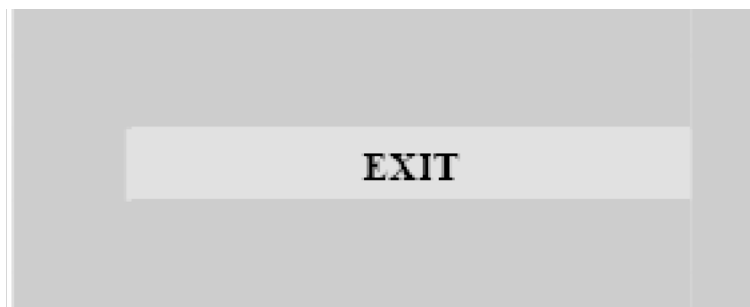

- Main Menu -- DISPLAY IN SCREEN



- Sub-Menu – DISPLAY IN SCREEN





- Available Key Functions

	Power Off the LCD Monitor		Decrease the gauge value of the selected option.
	Return to last menu		Select to confirm
	Increase the gauge value of the selected option.		N/A

## A.2.13 Hot Keys

OSD LOCK/UNLOCK

HOT KEYS

Press  first then press  for change this setting, Followed this sequence for the button press so that you can have OSD LOCK and UNLOCK setting

Enter OSD LOCK MODE

Press HOT KEY, the screen will show this action first



**DO OSD LOCK**

- Don't remove the HOT KEY until the screen indicated this task is finished.



**OSD LOCK**

- Entry OSD UNLOCK MODE
- Press HOT KEY, the screen will show this action first



**DO OSD UNLOCK**

- Don't remove the HOT KEY until the screen indicated this task is finished.



**OSD UNLOCK**



# Appendix **B**

Setting Serial Data for  
Expansion

## B.1 Setting Serial Data for Expansion

The several timings below are already programmed in this module.  
The input synchronous signals are automatically recognized.

### FPM-3121G-R3BE

Resolution	HSYNC /KHz (+/-)	VSYNC /Hz (+/-)	PIXEL RATE /MHz
IBM, 720 * 400	31.469	70.087	28.322
VESA 640 * 480	31.469	59.940	25.175
VESA 800 * 600	35.156	56.250	36.000
VESA 800 * 600	37.879	60.317	40.000
VESA 1024*768	48.363	60.004	65.000

### FPM-3151G-R3BE

Resolution	HSYNC /KHz (+/-)	VSYNC /Hz (+/-)	PIXEL RATE /MHz
IBM, 720 * 400	31.469	70.087	28.322
VESA 640 * 480	31.469	59.940	25.175
VESA 640 * 480	37.861	72.809	31.500
VESA 640 * 480	37.500	75.000	31.500
VESA 800 * 600	35.156	56.250	36.000
VESA 800 * 600	37.879	60.317	40.000
VESA 800 * 600	48.077	72.188	50.000
VESA 800 * 600	46.875	75.000	49.500
VESA 1024*768	48.363	60.004	65.000
VESA 1024*768	56.476	70.069	75.000
VESA 1024*768	60.023	75.029	78.750

### FPM-3171G-R3BE/FPM-3191G-R3BE

Resolution	HSYNC /KHz (+/-)	VSYNC /Hz (+/-)	PIXEL RATE /MHz
IBM, 720 * 400	31.469	70.087	28.322
VESA 640 * 480	31.469	59.941	25.175
VESA 640 * 480	37.861	72.810	31.500
VESA 640 * 480	37.500	75.000	31.500
VESA 800-5	35.156	56.250	36.000
VESA 800-6	37.879	60.317	40.000
VESA 800-7	48.077	72.188	50.000
VESA 800-75	46.875	75.000	49.500
VESA 1024-6	48.363	60.004	65.000
VESA 1024-7	56.476	70.069	75.000
VESA 1024*75	60.023	75.029	78.750
VESA 1280 x 1024	63.981	60.02	108.000
VESA 1280 x 1024	79.976	75.024	135.000

**Note!**  Even if the preset timing is entered, a little adjustment of the functions such as Horizontal period, CLK-delay and display position, are required. The adjusted values are memorized in every preset number.

**Note!**  This module recognizes the synchronous signals with near preset timing of the frequency of the HS and Vsync, even in the case that the signals other than the preset timing that were entered.

**Note!**  Because adjustments may not fit, such as differing magnifying ratios or, in the case that you use it except for the display timing that was preset. Recommend best resolution as 1920\*1080.

## B.2 Touch screen RS232 Connector Pin Definition

Pin	RS232
1	-
2	TXD
3	RXD
4	DTR
5	GND
6	DSR
7	RTS
8	-
9	-

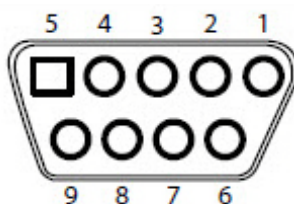

## [www.advantech.com](http://www.advantech.com)

Please verify specifications before quoting. This guide is intended for reference purposes only.

All product specifications are subject to change without notice.

No part of this publication may be reproduced in any form or by any means, electronic, photocopying, recording or otherwise, without prior written permission of the publisher.

All brand and product names are trademarks or registered trademarks of their respective companies.

© Advantech Co., Ltd. 2016