

User Manual

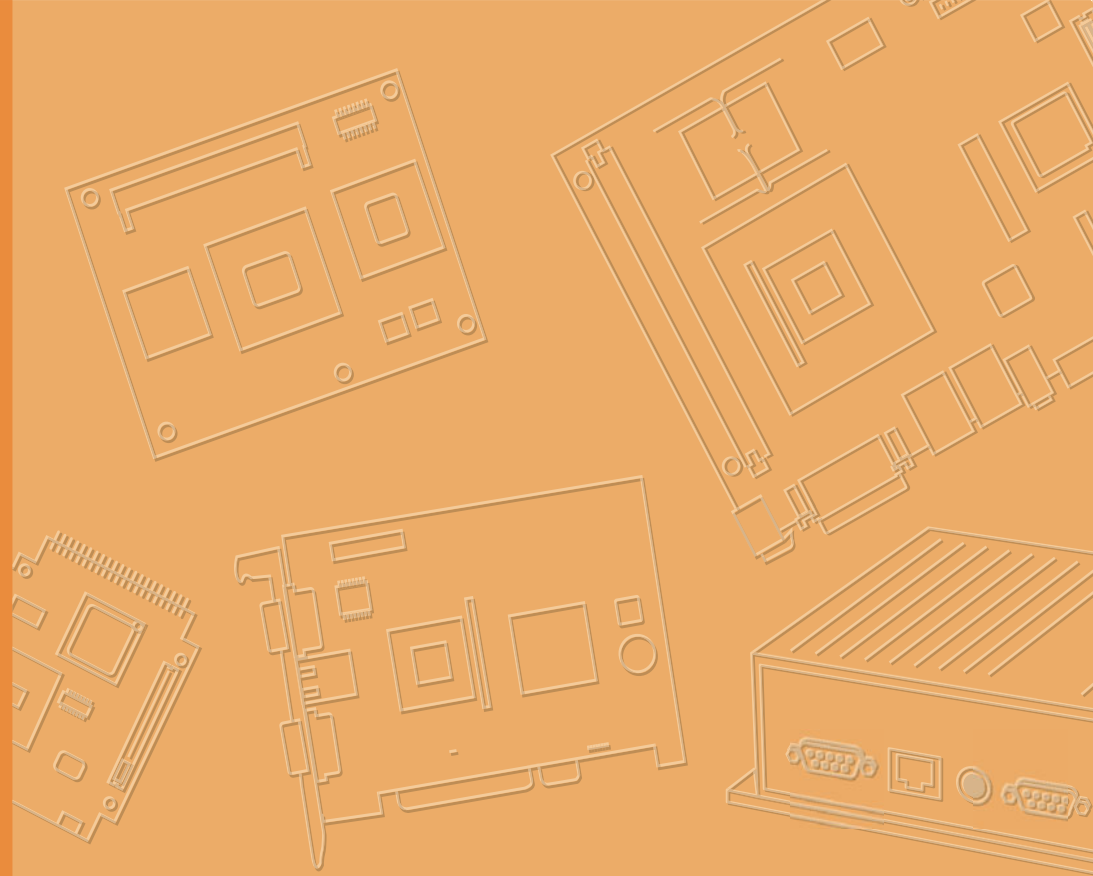

TREK-668/TREK-303

**In-Vehicle Hybrid MDT/
Surveillance Smart Display**

Copyright

The documentation and the software included with this product are copyrighted 2013 by Advantech Co., Ltd. All rights are reserved. Advantech Co., Ltd. reserves the right to make improvements in the products described in this manual at any time without notice. No part of this manual may be reproduced, copied, translated or transmitted in any form or by any means without the prior written permission of Advantech Co., Ltd. Information provided in this manual is intended to be accurate and reliable. However, Advantech Co., Ltd. assumes no responsibility for its use, nor for any infringements of the rights of third parties, which may result from its use.

Acknowledgements

TI and AM37x are trademarks of Texas Instruments..

Microsoft Windows and MS-DOS is registered trademarks of Microsoft Corp.

All other product names or trademarks are properties of their respective owners.

Product Warranty (2 years)

Advantech warrants to you, the original purchaser, that each of its products will be free from defects in materials and workmanship for two years from the date of purchase.

This warranty does not apply to any products which have been repaired or altered by persons other than repair personnel authorized by Advantech, or which have been subject to misuse, abuse, accident or improper installation. Advantech assumes no liability under the terms of this warranty as a consequence of such events.

Because of Advantech's high quality-control standards and rigorous testing, most of our customers never need to use our repair service. If an Advantech product is defective, it will be repaired or replaced at no charge during the warranty period. For out-of-warranty repairs, you will be billed according to the cost of replacement materials, service time and freight. Please consult your dealer for more details.

If you think you have a defective product, follow these steps:

1. Collect all the information about the problem encountered. (For example, CPU speed, Advantech products used, other hardware and software used, etc.) Note anything abnormal and list any onscreen messages you get when the problem occurs.
2. Call your dealer and describe the problem. Please have your manual, product, and any helpful information readily available.
3. If your product is diagnosed as defective, obtain an RMA (return merchandise authorization) number from your dealer. This allows us to process your return more quickly.
4. Carefully pack the defective product, a fully-completed Repair and Replacement Order Card and a photocopy proof of purchase date (such as your sales receipt) in a shippable container. A product returned without proof of the purchase date is not eligible for warranty service.
5. Write the RMA number visibly on the outside of the package and ship it prepaid to your dealer.

Part No.
Printed in Taiwan

Edition 1
February 2013

Declaration of Conformity

CE

This product has passed the CE test for environmental specifications. Test conditions for passing included the equipment being operated within an industrial enclosure. In order to protect the product from being damaged by ESD (Electrostatic Discharge) and EMI leakage, we strongly recommend the use of CE-compliant industrial enclosure products.

FCC Class B

Note: This equipment has been tested and found to comply with the limits for a Class B digital device, pursuant to part 15 of the FCC Rules. These limits are designed to provide reasonable protection against harmful interference in a residential installation. This equipment generates, uses and can radiate radio frequency energy and, if not installed and used in accordance with the instructions, may cause harmful interference to radio communications. However, there is no guarantee that interference will not occur in a particular installation. If this equipment does cause harmful interference to radio or television reception, which can be determined by turning the equipment off and on, the user is encouraged to try to correct the interference by one or more of the following measures:

- Reorient or relocate the receiving antenna.
- Increase the separation between the equipment and receiver.
- Connect the equipment into an outlet on a circuit different from that to which the receiver is connected.
- Consult the dealer or an experienced radio/TV technician for help.

Technical Support and Assistance

1. Visit the Advantech web site at <http://support.advantech.com> where you can find the latest information about the product.
2. Contact your distributor, sales representative, or Advantech's customer service center for technical support if you need additional assistance. Please have the following information ready before you call:
 - Product name and serial number
 - Description of your peripheral attachments
 - Description of your software (operating system, version, application software, etc.)
 - A complete description of the problem
 - The exact wording of any error messages

Warnings, Cautions and Notes

Warning! Warnings indicate conditions, which if not observed, can cause personal injury!



Caution! Cautions are included to help you avoid damaging hardware or losing data. e.g.



There is a danger of a new battery exploding if it is incorrectly installed. Do not attempt to recharge, force open, or heat the battery. Replace the battery only with the same or equivalent type recommended by the manufacturer. Discard used batteries according to the manufacturer's instructions.

Note! Notes provide optional additional information.



Document Feedback

To assist us in making improvements to this manual, we would welcome comments and constructive criticism. Please send all such - in writing to: support@advantech.com

Packing List

Before setting up the system, check that the items listed below are included and in good condition. If any item does not accord with the table, please contact your dealer immediately.

- TREK-668 series In-Vehicle Hybrid MDT/Surveillance Computing Box
- USB/Audio cable clip
- Warranty card
- Power cord: DC power inlet cable (180 cm - for TREK-668 only)
- Video in/CAN cable
- "Drivers, Utilities and User Manual" CD-ROM
- End User License Agreement (XPE and WinCE model), please download driver and related document from <http://support.advantech.com>

Ordering Information

P/N	Description
TREK-668-GWB7A0E	Intel Atom N2600 1.6 Ghz, GPS, GPRS,Wlan,BT, 16G CF, Win7
TREK-668-GHB7A0E	Intel Atom N2600 1.6 Ghz , GPS, HSDPA,BT,16G CF, Win7
TREK-668-00A0E	Intel Atom N2600 1.6 Ghz, Barebone
TREK-303D-HA0E	7" vehicle display system, 800 x 480 resolution, with 4 wire resistive touch screen, 2-watts speaker x 2
1700018342	2-meter Cable

Safety Instructions

1. Read these safety instructions carefully.
2. Keep this User Manual for later reference.
3. Disconnect this equipment from any AC outlet before cleaning. Use a damp cloth. Do not use liquid or spray detergents for cleaning.
4. For plug-in equipment, the power outlet socket must be located near the equipment and must be easily accessible.
5. Keep this equipment away from humidity.
6. Put this equipment on a reliable surface during installation. Dropping it or letting it fall may cause damage.
7. Do not leave this equipment in an environment unconditioned where the storage temperature under -30° C (-22° F) or above 70° C (158° F), it may damage the equipment. Operating temperature: 50° C
8. The openings on the enclosure are for air convection. Protect the equipment from overheating. **DO NOT COVER THE OPENINGS.**
9. Make sure the voltage of the power source is correct before connecting the equipment to the power outlet.
10. Position the power cord so that people cannot step on it. Do not place anything over the power cord. The voltage and current rating of the cord should be greater than the voltage and current rating marked on the product.
11. All cautions and warnings on the equipment should be noted.
12. If the equipment is not used for a long time, disconnect it from the power source to avoid damage by transient overvoltage.
13. Never pour any liquid into an opening. This may cause fire or electrical shock.
14. Never open the equipment. For safety reasons, the equipment should be opened only by qualified service personnel.
15. If one of the following situations arises, get the equipment checked by service personnel:
 - The power cord or plug is damaged.
 - Liquid has penetrated into the equipment.
 - The equipment has been exposed to moisture.
 - The equipment does not work well, or you cannot get it to work according to the user's manual.
 - The equipment has been dropped and damaged.
 - The equipment has obvious signs of breakage.

16. CAUTION: The computer is provided with a battery-powered real-time clock circuit. There is a danger of explosion if battery is incorrectly replaced. Replace only with same or equivalent type recommended by the manufacture. Discard used batteries according to the manufacturers instructions.
17. THE COMPUTER IS PROVIDED WITH CD DRIVES COMPLY WITH APPROPRIATE SAFETY STANDARDS INCLUDING IEC 60825.

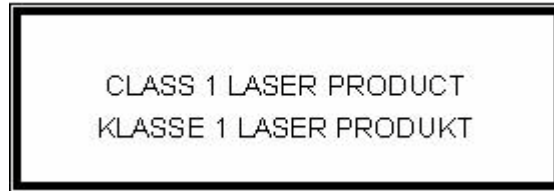

18. This device complies with Part 15 of the FCC rules. Operation is subject to the following two conditions:
 - (1) this device may not cause harmful interference, and
 - (2) this device must accept any interference received, including interference that may cause undesired operation.
19. CAUTION: Always completely disconnect the power cord from your chassis whenever you work with the hardware. Do not make connections while the power is on. Sensitive electronic components can be damaged by sudden power surges.
20. CAUTION: Always ground yourself to remove any static charge before touching the motherboard, backplane, or add-on cards. Modern electronic devices are very sensitive to static electric charges. As a safety precaution, use a grounding wrist strap at all times. Place all electronic components on a static-dissipative surface or in a static-shielded bag when they are not in the chassis.
21. CAUTION: Any unverified component could cause unexpected damage. To ensure the correct installation, please always use the components (ex. screws) provided with the accessory box.
22. Caution text concerning lithium batteries:



23. "Rack Mount Instructions - The following or similar rack-mount instructions are included with the installation instructions:
 - A) Elevated Operating Ambient - If installed in a closed or multi-unit rack assembly, the operating ambient temperature of the rack environment may be greater than room ambient. Therefore, consideration should be given to installing the equipment in an environment compatible with the maximum ambient temperature (T_{ma}) specified by the manufacturer.
 - B) Reduced Air Flow - Installation of the equipment in a rack should be such that the amount of air flow required for safe operation of the equipment is not compromised.
 - C) Mechanical Loading - Mounting of the equipment in the rack should be such that a hazardous condition is not achieved due to uneven mechanical loading.
 - D) Circuit Overloading - Consideration should be given to the connection of the equipment to the supply circuit and the effect that overloading of the circuits

might have on over current protection and supply wiring. Appropriate consideration of equipment nameplate ratings should be used when addressing this concern.

E) Reliable Earthing - Reliable earthing of rack-mounted equipment should be maintained. Particular attention should be given to supply connections other than direct connections to the branch circuit (e.g. use of power strips)."

Safety Precaution - Static Electricity

Follow these simple precautions to protect yourself from harm and the products from damage.

- To avoid electrical shock, always disconnect the power from your system chassis before you work on it. Don't touch any components on the main board or other cards while the system is on.
- Disconnect power before making any configuration changes. The sudden rush of power as you connect a jumper or install a card may damage sensitive electronic components.

Warning!



1. *Input voltage rated: 9 ~ 36 Vdc.*
2. *Transport: carry the unit with both hands and handle with care.*
3. *Maintenance: to properly maintain and clean the surfaces, use only approved products or clean with a dry applicator.*
4. *CompactFlash: Turn off the power before inserting or removing CompactFlash storage cards.*

European Contact Information:

Advantech Europe GmbH Kolberger Straße 7

D-40599 Düsseldorf, Germany

Tel: 49-211-97477350

Fax: 49-211-97477300

Contents

Chapter 1	General Information	1
1.1	Introduction	2
1.2	General Specifications	3
1.3	Dimensions	4
	Figure 1.1 TREK-668 dimensions.....	4
Chapter 2	System Setup	5
2.1	A Quick Tour of the TREK-668 Computing Box.....	6
	Figure 2.1 Front view of TREK-668	6
	Figure 2.2 Rear view of TREK-668	6
	Figure 2.3 Side view of TREK-668	6
	Figure 2.4 Bottom view of TREK-668	6
	Figure 2.5 Top view of TREK-668	7
2.2	Installation Procedures.....	7
	2.2.1 Connecting the Power Cord.....	7
	Table 2.1: Pin Definition of Power Cord	7
	2.2.2 Power Connector (12/24V; 9 ~ 32V).....	8
	Table 2.2: Power Connector	8
	Figure 2.6 Power connector photo.....	8
2.3	Running the BIOS Setup Program	9
2.4	Installing the Drivers for Win XP	9
Chapter 3	Hardware & Peripheral Installation ..	11
3.1	Overview of Hardware Installation & Upgrading	12
3.2	Installing the Storage Device and Memory	12
3.3	Installing Optional Accessories	12
	3.3.1 Installing TREK-668 Peripheral Modules.....	12
	Figure 3.1 Install peripheral in the system	12
	3.3.2 Installing the MiniPCI Type WWAN, SIM, WLAN, CF Card, SIM Card and HDD	13
	Figure 3.2 Mini PCI type WWAN module view	13
	3.3.3 Installing CF Card	13
	Figure 3.3 Installing CF Card.....	13
	Figure 3.4 Install USB cable clip.....	13
	3.3.4 GPS Module.....	14
3.4	Paired with TREK-303 Specifications	14
Chapter 4	Jumper Settings and	15
Chapter 4	Connectors.....	15
4.1	Setting Jumpers and Switches.....	16
	4.1.1 Locations of the Jumpers and Connector	16
	Figure 4.1 Locations of jumpers and connectors on top side the motherboard	16
	Figure 4.2 Locations of jumpers and connectors on bottom side of the motherboard	17
	4.1.2 Jumpers	17

	Table 4.1: Jumpers on Motherboard	17
4.1.3	Connectors	17
	Table 4.2: Connectors on Motherboard.....	17
4.2	Jumper Settings.....	18
4.2.1	CMOS Clear for External RTC (J1)	18
	Table 4.3: Clear CMOS / External RTC (JP1).....	18
4.2.2	CAN bus termination selection (CN16).....	18
	Table 4.4: CAN bus termination selection (CN16)	18
4.2.3	Pin 9 of COM9 Function Selection (CN20)	19
	Table 4.5: Pin 9 of COM9 Function Selection (CN20).....	19
	Table 4.6:	19
4.2.4	Mini-PCIe Socket Function Selection (SW2)	19
	Table 4.7: Mini-PCIe Socket Function Selection (SW2).....	19
4.2.5	Mini-PCIe Socket Voltage Adjustment Level (SW3)	19
	Table 4.8: Mini-PCIe Socket Function Selection (SW3).....	19
4.2.6	WWAN Socket Voltage Adjustment Level (SW4)	19
	Table 4.9: Mini-PCIe Socket Function Selection (SW4).....	19
4.2.7	COM Port Interface.....	20
	Table 4.10: Serial Port Function.....	20
	Table 4.11: Serial Port Settings.....	20

Chapter 5 Pin Assignments 21

5.1	Front Side Connectors	22
5.2	Rear Side Connectors.....	22
5.3	LED Indicator	22
5.4	Power Connector (12/24V; 9 ~ 32V).....	23
	Table 5.1: Power Connector.....	23
5.5	CAN/J1708 Connector	24
	Table 5.2: CAN/J1708 Connector	24
5.6	CAN / Video-In Connector	24
	Table 5.3: CAN / Video-In Connector.....	24
5.7	HDC (High Density Connector) (CN27)	25
	Table 5.4: High Density Connector	25
5.8	Smart Display Connector	26
	Table 5.5: Smart Display Connector	26
5.9	VGA & RS-232 Connector (CN24).....	27
	Table 5.6: RS232 Connector(COM9).....	27
	Table 5.7: VGA Connector	27
5.10	Video Input Connector (CN25).....	28
	Table 5.8: Video Input Connector 1.....	28
	Table 5.9: Video Input Connector 2.....	29
5.11	Back USB Connector (CN23)	29
	Table 5.10: USB Connector	29
5.12	Front USB Connector (CN21)	30
	Table 5.11: USB Connector	30

Chapter 6 Software Demo Utility 31

Chapter 6 Setup 31

6.1	Introduction	32
6.1.1	Execute J1939 Demo Utility.....	32
	Figure 6.1 IMC demo utility.....	32
	Figure 6.2 J1939 test - 1.....	33
	Figure 6.3 J1939 test - 2.....	33
6.1.2	Execute CAN Demo Utility.....	34

	Figure 6.4 CAN test	34
6.2	RTC Test.....	35
	Figure 6.5 RTC test - 1	35
	Figure 6.6 RTC test - 2	35
	Figure 6.7 RTC test - 3	36
	Figure 6.8 RTC test - 4	36
	Figure 6.9 RTC test - 5	37
6.3	Vehicle Power Management	37
6.3.1	Power Management Mechanism	37
6.3.2	Power Management Utility Program	39
6.3.3	Power Management Parameter Settings	39
	Figure 6.10Power management test utility	39
6.3.4	TREK-668 Power Consumption.....	40
6.4	Digital IO Test	40
	Figure 6.11DI/O test	40
	Figure 6.12Digital in.....	41
	Figure 6.13Digital out (Need Ned to create this picture for TREK-668)	41
6.5	Video in Test	42
	Figure 6.14Video test utility	42
6.6	Dead Reckoning.....	42
6.7	G-sensor (3-axis Accelerometer)	42
6.8	Core Function.....	43
	Figure 6.15Core Function test	43
6.9	SMBus & I2C Control	43
	Figure 6.16Core Function test	43
6.10	Hardware Monitor.....	44
	Figure 6.17Hardware Monitor test	44
6.11	Peripheral Control	45
	Figure 6.18Peripheral Control test.....	45
6.12	Roaming Control	45
	Figure 6.19Roaming Control test.....	45
6.13	Heater	46
	Figure 6.20Heater test	46
6.14	Altimeter	48
	Figure 6.21Altimeter test.....	48
6.15	Watch Dog	49
	Figure 6.22Watch Dog test	49

Appendix A TREK-303.....51

A.1	Paired with TREK-303 Specifications	52
	Table A.1: TREK-303 Specification	52
	Table A.2: Smart Display Connector.....	53
	Figure A.1 Hotkey utility	55
A.2	TREK-668 Attached Cable Packet Indicator	56
	Table A.3: Power M12 JACK Cable Pin Depiction.....	56
A.3	LAN M12 Jack Cable	57
	Table A.4: LAN M12 JACK Cable Connector Pin Depiction	57
A.4	DB15 Cable	58
	Table A.5: DB15 Cable Connector Pin Depiction	58
A.5	DVI Video Input Cable.....	59
	Table A.6: Video Input Cable Connector Pin Depiction	59
A.6	HDC Cable	60
	Table A.7: HDC Cable Pin Depiction	60
	Table A.8: HDC Cable Pin Depiction	60

Chapter 1

General Information

This chapter gives background information on the TREK-668/303 In-Vehicle Hybrid MDT/Surveillance Computing Box.

Sections include:

- Introduction
- General Specifications
- Dimensions

1.1 Introduction

TREK-668 is an industrial degree Dual core mobile Digital Video recorders designed to provide high-quality video surveillance and fleet management for police car, ambulance, fire engine, buses and trains. TREK-668 delivers not only tracking and positioning, which can also support dead-reckoning feature, which means the truck can still be traced even the driver is driving in a tunnel ,and vehicle diagnostic J1939 protocol in order to manage driver behavior, but also with high-quality, MPEG-4, MJPEG, H.264 recording, H.264 and transmission for up to 16 camera inputs, one PSE for IP camera, and dual display/dual audio interfaces supporting different resolutions can deliver different applications to different displays. Each camera input provides motion detection capabilities;16 audio inputs. The Hybrid DVR Series provides a hybrid recording function allowing for images to be transmitted as either digital video signals using Advantech Power View SW or as analog video signals. The Hybrid DVR Series provides reliable on-board recording a can transmit images or alarms for remote monitoring over a wireless, GPRS, 3G, or HSDPA network connection.

I/O Connectors

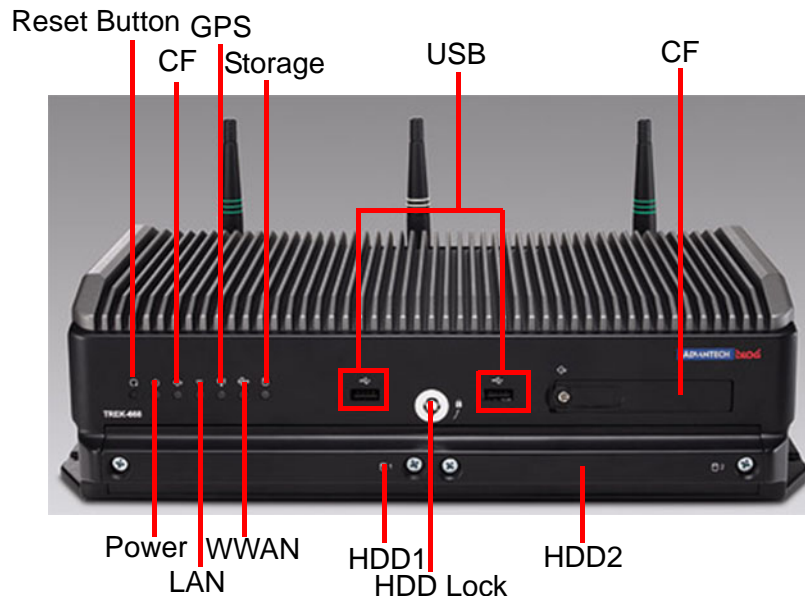
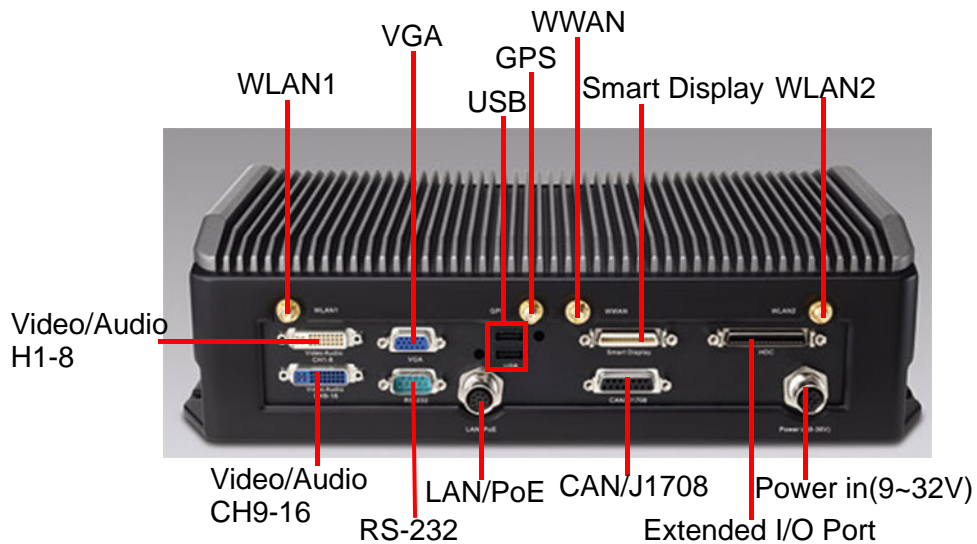

1.2 General Specifications

Key features

- Supports WES7/Win7
- Automotive grade working temperature range (-30° C to 60° C)
- Rich I/O including CAN, LAN, RS-232, RS-485, J1708, isolation 8DI/4DO, Line out, Mic in, USB.
4/8/16 video input, one PSE for IP Camera supports 30 frames DI resolution per channel per second.
- Built-in communication modules, including GPRS/HSDPA/CDMA, Wlan & Bluetooth.
- GPS with AGPS and dead reckoning technology (Gyro & speed line)
- Certifications: CE/FCC/E-mark, MIL-SD810F, ISO 7637-2, SAE J1455, SAE J1113 regulations
- Ignition on/off delay; SW controllable for car power management
-

Specifications

- **Dimensions: (W x H x D):** 346 x 97 x 196.2 mm
- **Weight:** 4 kg
- **Vehicle power feature:**
 - Input voltage: 9 ~ 32 Vdc, support ignition cold crank
 - Supports Ignition on/off
 - Supports low battery shut-down protection threshold (optional)
 - Supports power off event delay
 - Supports power on delay
 - Supports power low delay
 - Supports power low hard delay
 - Supports hard off delay

Note! For more detail of function please refer to Chapter 6, Section 6.3 of this manual.



- **Enclosure:** Ruggedized aluminum without ventilation holes.
- **CPU:** Cedar View, Intel Atom N2600 1.6Ghz (Dual Core)
- **Chipset:** Intel NM10 Express Chipset(Tiger Point)
- **BIOS:** 4MB Flash BIOS, ACPI Compliant.
- **System memory:** DDR 800MHz, up to 2GB
- **Storage:**
 - CF: Supports type I/II CompactFlash card for OS storage
 - SSD/HDD: supports
- **Serial ports:** Two RS-232, 12V/0.5A via DB9, One via extended I/O Port. Two 2-wire RS232, 2x RS485, 1 x J1708 (DB15) ports. DIO: 8 in, 4 out
- **Universal serial bus (USB) port:** Supports up to three USB2.0.Two on rear I/O panel, 1 on front panel and one for TREK-303
- **LAN (PSE) port:** 1 x Giga LAN 10/100/1000Mbps Ethernet controller support POE IP camera
- **CAN BUS Port:** 1 CAN Bus (Protocol J1939)
- **LED:** Power, CF, Wifi, WWAN, GPS, HDD/SSD

- **Video output:** 1 x VGA output by DB-15 (independent display).
- **Video in surveillance:** 4/8/12 Video inputs with 12V/2A power supply for camera
- **Mini PCI express bus expansion slot:** Accepts full size mini PCI bus card.
- **Watchdog timer:** Supports 0-255 sec. time intervals, SW programmable and SW enable/disabled.
- **RTC Battery:** 3.0 V @ 200 mAH lithium battery.
- **Power management:** Supports power saving modes including Normal/ suspend-to-disk modes.
- **Digital I/O:** Isolated 8 digital input and 4 digital output
- **CAN bus:** Support CAN V2.0B up to 500 kb/s.
- **Audio:** One audio codes for smart display, line out and min in phone jack.
- **Optional modules:**
 - GPS:
 - LEA-6S: 50 channels GPS
 - LEA-6R: 16 channels dead reckoning GPS
 - RF:
 - Quad-band GSM/GPRS, HSDPA, CDMA
- **PCI Express Bus Ethernet Interface:** Ethernet: support 1000/100/10Base-T
- auto-sensing capability.
- **Operating temperature:** -30 ~ 60° C
- **Relative humidity:** 10 ~ 95% @ 40° C (non-condensing)
- **Shock:** 100 G peak acceleration (6 msec duration)
- **Certifications:** CE, FCC, CCC, Emark
- **Vibration:** 5 ~ 500 Hz SAE J1455 4.9.4.2, MIL-STD-810F 514.5

1.3 Dimensions

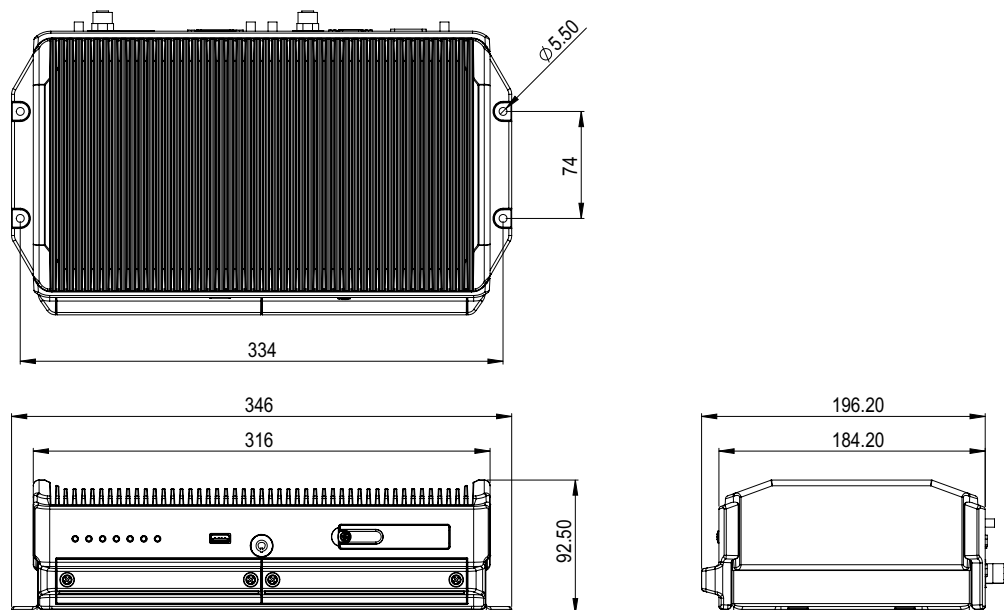

Figure 1.1 TREK-668dimensions

Chapter 2

System Setup

This chapter details system setup on TREK-668/303.

Sections include:

- A Quick Tour of the Computer Box
- Installation Procedures
- Running the BIOS Setup Program
- Installing the Drivers for Win XP

2.1 A Quick Tour of the TREK-668 Computing Box

Before starting to set up the In-Vehicle Computing Box, take a moment to become familiar with the locations and functions of the controls, drives, connectors and ports, which are illustrated in the figures below. When the Computer box is placed inside truck glove cabinet or under the passenger's seat next to the driver, its front appears as shown in Figure 2.1.

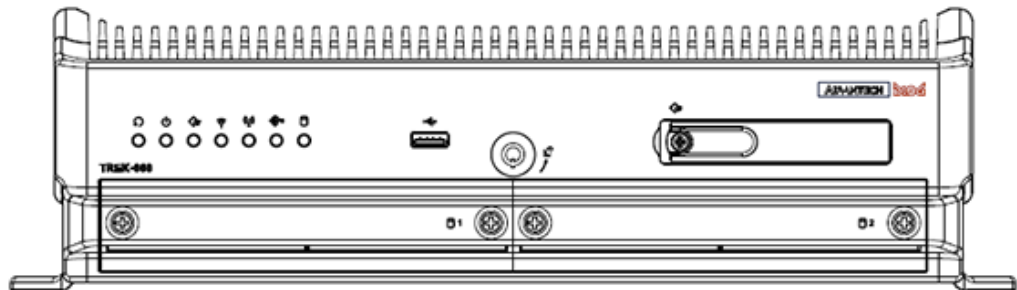

Figure 2.1 Front view of TREK-668

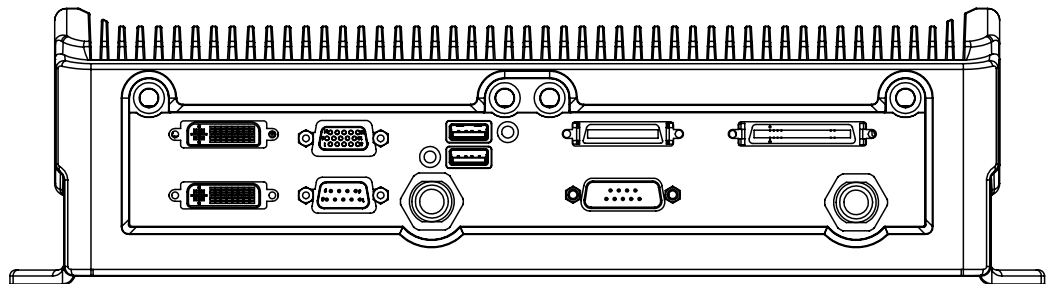

Figure 2.2 Rear view of TREK-668

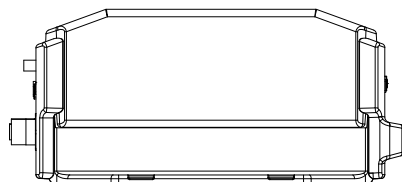

Figure 2.3 Side view of TREK-668

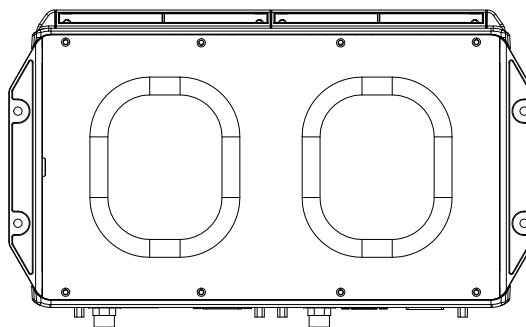

Figure 2.4 Bottom view of TREK-668

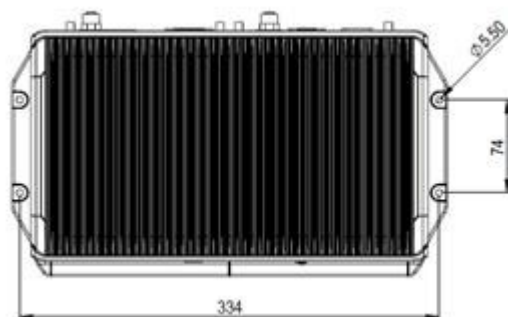

Figure 2.5 Top view of TREK-668

2.2 Installation Procedures

2.2.1 Connecting the Power Cord

Connect the three pin waterproof power cord to the DC inlet of the In-Vehicle Computing Box. On the open-wire end, one pin is reserved for positive voltage and is marked, "+"; one pin is reserved for ground and is marked, "-"; and, one pin is reserved for the ignition signal with an "ignition" mark.

Note! *Ignition on/off setting: The TREK-668 supports an ignition on/off function so that you can power on/off the TREK-668 via the ignition signal/voltage and connect the TREK- vehicle ignition switch.*



Table 2.1: Pin Definition of Power Cord

Pin	Definition	Color
1	+	Red
2	-	Black
3	Ignition	Orange

2.2.2 Power Connector (12/24V; 9 ~ 32V)

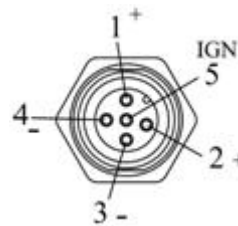

Connector type: M12 A-coding Jack GT234102-02050 female 5P

Table 2.2: Power Connector

Pin	Signal Depiction
1	Power Input (9 ~ 32 VDC)
2	Power Input (9 ~ 32 VDC)
3	Ground
4	Ground
5	Acc Ignition Input

Cable Part number: 1700020122



Figure 2.6 Power connector photo

Note! Fuse holder: The fuse holder on the power cable is water/dust proof; you may change the fuse (5 Amp) easily by yourself.



2.3 Running the BIOS Setup Program

In most cases, the computer will have been properly set up and configured by the dealer or SI prior to delivery. However, it may still be necessary to adjust some of the computer's BIOS (Basic Input-Output System) setup programs to change the system configuration data, like the current date and time, or the specific type of hard drive currently installed.

The setup program is stored in read-only memory (ROM). It can be accessed either when turning on or resetting the computer, by pressing the "Del" key on the keyboard immediately after powering up the computer.

The settings that are specified with the setup program are recorded in a special area of the memory called CMOS RAM. This memory is backed up by a battery so that it will not be erased when turning off or resetting the system. Whenever the power is turned on, the system reads the settings stored in CMOS RAM and compares them to the equipment check conducted during the power on self-test (POST). If an error occurs, an error message is displayed on screen, and the user is prompted to run the setup program.

2.4 Installing the Drivers for Win XP

After installing system software, the computer is ready to set up the Intel Atom N2600 VGA, audio, LAN, and touch screen functions. All the pre-requisite drivers are stored on a CD-ROM disc entitled "Drivers and Utilities" (Check the correct wording on the CD, which can be found in the accessory box.)

The utility directory includes multimedia programs. Some drivers and utilities in the CD-ROM disc have their own text files which help users install the drivers and understand their functions.

These files are a very useful supplement to the information in this manual. For more updated driver please refers to Advantech website, www.advantech.com/support

The drivers for TREK-668 are listed as below, please just execute the drivers for installation.

Device	Version
Intel NM10 INF Update	9.2.2.1034
Intel GMA3600 Graphic Driver	8.14.8.1075
PenMount Universal Driver	2.1.0.263
INTEL 82583V 10/100/1000 PCI-E	11.14.48.0
VIA VT1708S High Definition Audio	6.0.1.10100
FTDI FT4232 BUS USB Driver	2.814.0
Sierra Wireless MC5728V	Watcher 7.11
Sierra Wireless MC8090/92	3GWatcher Build2258
INTEL N62205 Wireless LAN Card	14.3.0.6
BT-203 Utility BlueSoleil (Optional)	6.1.760.17607

Note!  *The drivers and utilities used for the TREK-668 are subject to change without notice. If you are in doubt, check Advantech's website or contact our application engineers for the latest information regarding drivers and utilities.*

Chapter 3

Hardware & Peripheral Installation

This chapter details the installation of hardware for TREK-668.

Sections include:

- Overview of Hardware Installation and Upgrading
- Installing the Storage Device and Memory
- Installing Optional Accessories
- Fuse

3.1 Overview of Hardware Installation & Upgrading

Vehicle Computing Box consists of a PC-based computer that is housed in a ruggedized aluminum enclosure. Any maintenance or hardware upgrades can be completed after removing the bottom cover plate.

Warning! Do not remove the ruggedized aluminum covers until verifying that no power is flowing within the computer. Power must be switched off and the power cord must be unplugged. Take care in order to avoid injury or damage to the equipment.



3.2 Installing the Storage Device and Memory

The In-Vehicle Computing Box can only use a Compact Flash Card (CFC) as a storage device. Put the CFC into the CF slot and insert the RAM into the 200-pin SODIMM socket on the main board.

3.3 Installing Optional Accessories

Optional accessories, like RAM mount kits or other functional modules are available for purchase to complement TREK-668. The following are instructions for accessory installation.

3.3.1 Installing TREK-668 Peripheral Modules

There are 8 screws on the bottom and top cover of TREK-668 each, if you want to install the peripherals in TREK-668, please use M3 type screw to open the system.

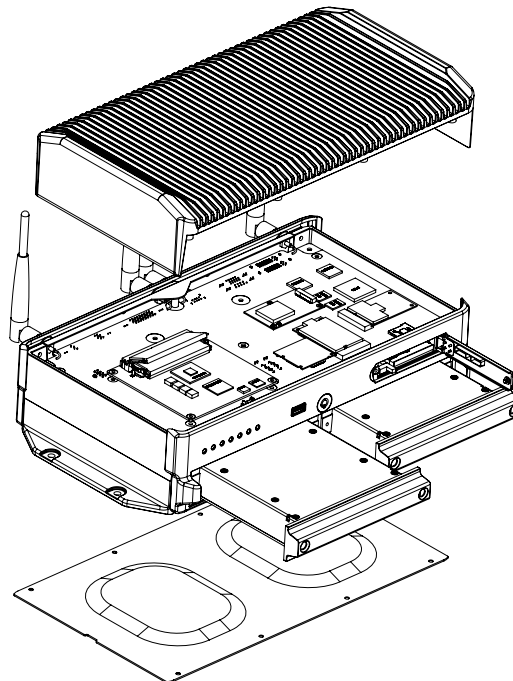

Figure 3.1 Install peripheral in the system

3.3.2 Installing the MiniPCI Type WWAN, SIM, WLAN, CF Card, SIM Card and HDD

The WWAN module is on the Mini PCI slot can be easily installed, just undo the 16 screws from the bottom cover and Top cover to install WWAN and WLAN.

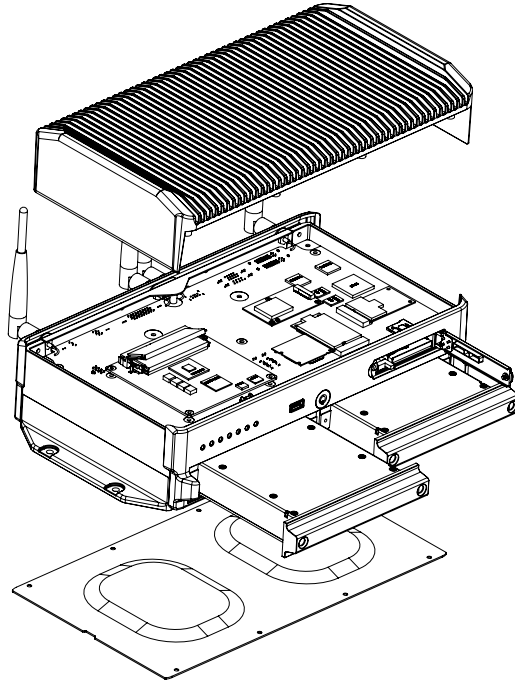

Figure 3.2 Mini PCI type WWAN module view

3.3.3 Installing CF Card

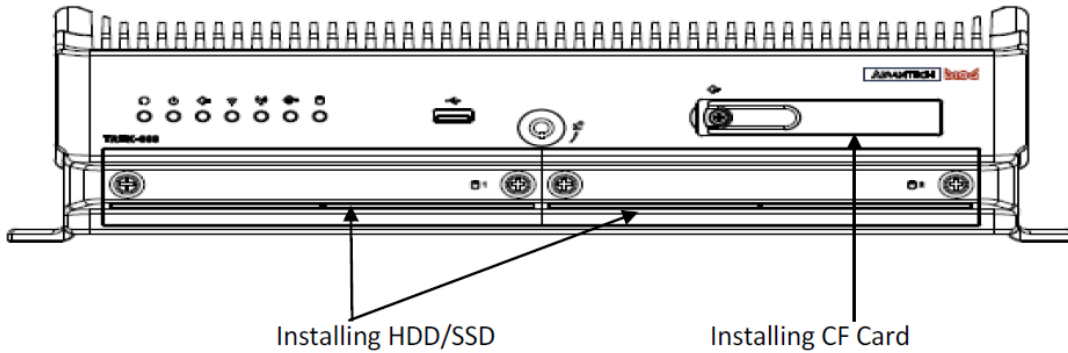

Figure 3.3 Installing CF Card

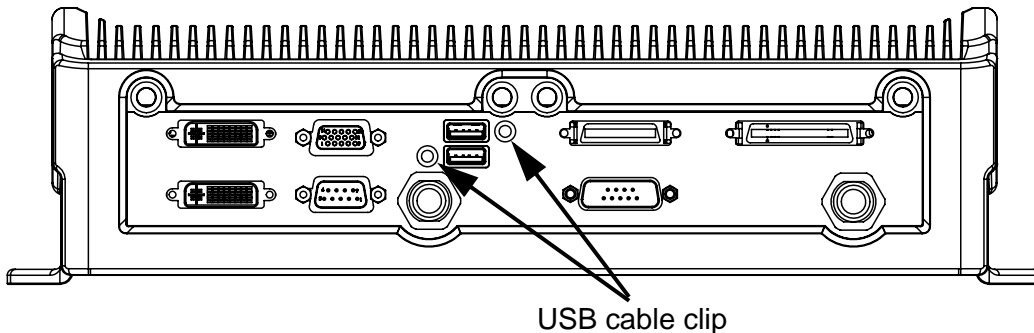

Figure 3.4 Install USB cable clip

3.3.4 GPS Module

The GPS module is not to be installed by the customer with breaking the warranty.

3.4 Paired with TREK-303 Specifications

See Appendix A

TREK-668 provides both VGA function and LCD to connect with TREK-303, it can output different content, clone to VGA output.

Chapter 4

Jumper Settings and Connectors

This chapter explains how to set up the In-Vehicle Computing Box hardware, including instructions on setting jumpers and connecting peripherals, and how to set switches and read indicators.

Be sure to read all the safety precautions before beginning the installation procedure.

Sections include:

- Setting Jumpers and Switches
- Jumpers Setting

4.1 Setting Jumpers and Switches

It is possible to configure the In-Vehicle Computing Box to match the needs of the application by resetting the jumpers. A jumper is the simplest kind of electrical switch. It consists of two metal pins and a small metal clip, often protected by a plastic cover that slides over the pins to connect them. To “close” a jumper, connect the pins with the clip. To “open” a jumper, remove the clip. Sometimes a jumper has three pins, labeled 1, 2, and 3. In this case, connect either pins 1 and 2, or pins 2 and 3.

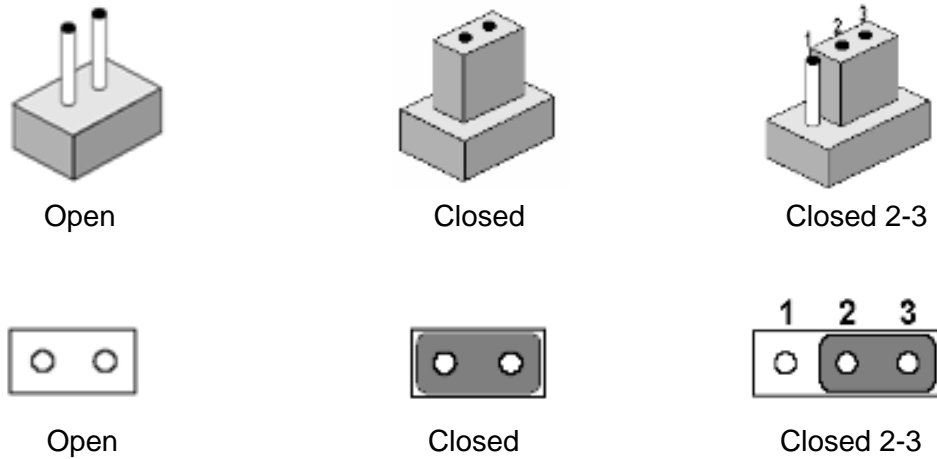

A pair of needle-nose pliers may be helpful when working with jumpers. If there are any doubts about the best hardware configuration for the application, contact the local distributor or sales representative before making any changes.

An arrow is used on the motherboard to indicate the first pin of each jumper.

4.1.1 Locations of the Jumpers and Connector

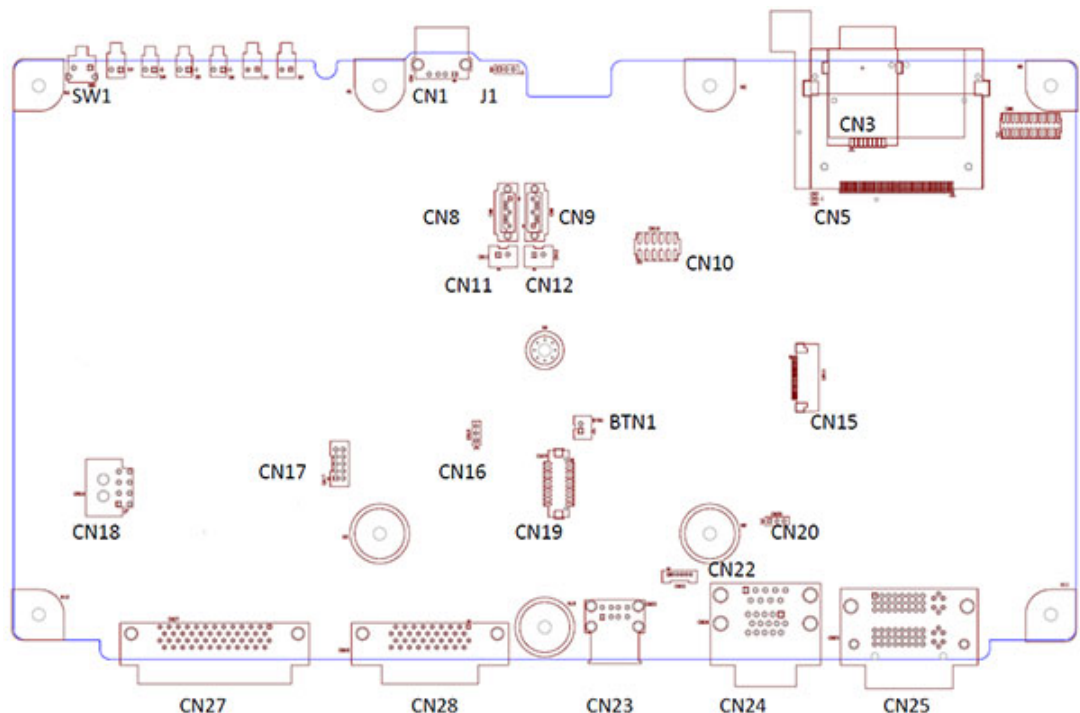

Figure 4.1 Locations of jumpers and connectors on top side the motherboard

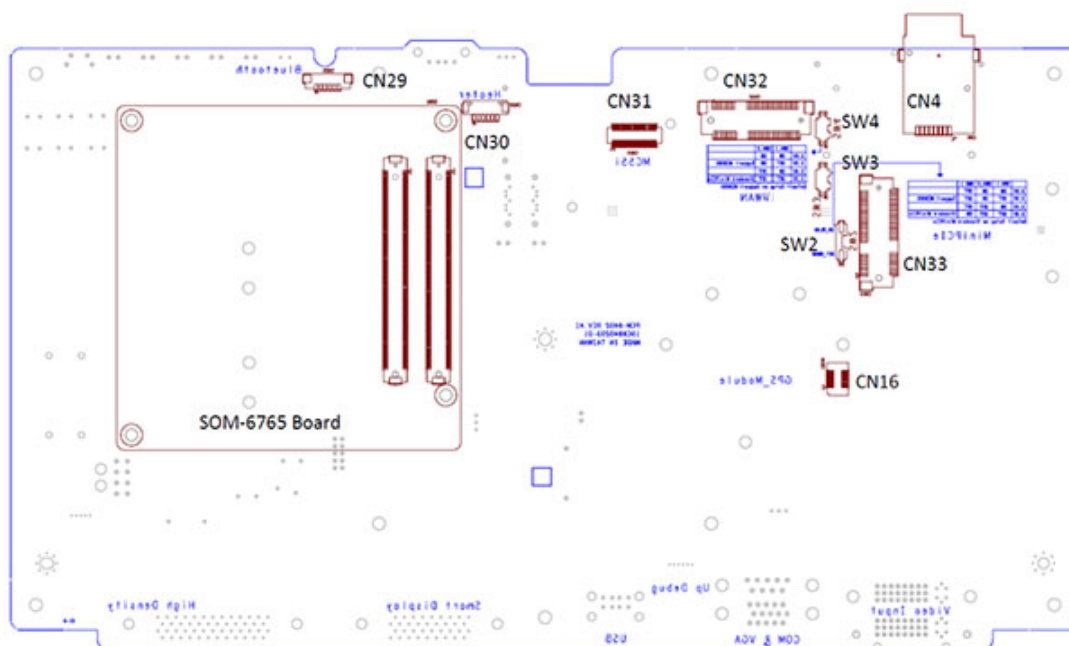

Figure 4.2 Locations of jumpers and connectors on bottom side of the motherboard

4.1.2 Jumpers

Table 4.1: Jumpers on Motherboard

Location	Function
J1	CMOS clear for external RTC
CN16	CAN bus termination selection
CN20	Pin9 of COM9 function selection

4.1.3 Connectors

On-board connectors link the In-Vehicle Computing Box to external devices such as hard disk drives. The table below lists the function of each connector.

Table 4.2: Connectors on Motherboard

Location	Function
CN1	Single USB connector
CN3	SIMCARD1
CN4	SIMCARD2
CN5	CF connector
CN8 & CN9	SATA0 &SATA1 connector
CN10	LPC connector (For Debug Use)
CN11 & CN12	SATA Power connector
CN15	EC Program connector
CN16	GPS Module connector
CN17	LAN connector
CN18	POWER INPUT connector (9~32v)
CN19	CAN BUS connector (CAN Bus+ J1708 + Di x 4 + DR)
CN23	Dual USB connector

CN24	VGA + COM connector
CN25	Camera Input connector
CN27	HDC connector
CN28	Smart Display connector
CN29	Bluetooth Module connector
CN30	Heater connector
CN31	MC55i Module connector
CN32	Mini-PCIe Socket (Only USB interface) Mini card
CN33	Mini-PCIe Socket(USB+PCIe interface)Mini card(standard interface)
SW1	RESET
SW2	Setting MiniPCIe(CN33) Socket Function Selection
SW3	Setting MiniPCIe(CN33) Adjustment 3.3 Voltage level Max to 3.6V
SW4	Setting MiniPCIe(CN32) Adjustment 3.3 Voltage level Max to 3.6V
BTN1	Power Button connector

4.2 Jumper Settings

4.2.1 CMOS Clear for External RTC (J1)



- Warning!** 1. To avoid damaging the computer, always turn off the power supply before setting “Clear CMOS”.
-  2. Set the jumper back to “Normal Operation” before turning on the power supply!

Table 4.3: Clear CMOS / External RTC (JP1)

Clear CMOS	Normal Operation (Default)
<p>1 2 3</p> 	<p>1 2 3</p> 

4.2.2 CAN bus termination selection (CN16)

TREK-668 must be configured properly according the vehicle power input range.

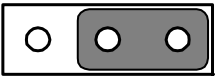
Table 4.4: CAN bus termination selection (CN16)

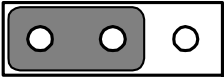
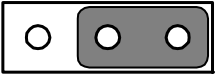
Disable Termination (Default)	Enable Termination
<p>1 2 3</p> 	<p>1 2 3</p> 

4.2.3 Pin 9 of COM9 Function Selection (CN20)

Pin 9 on COM9 port can be configured as RI or 12 V output.

Table 4.5: Pin 9 of COM9 Function Selection (CN20)

RI (Default)

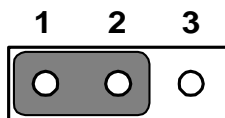
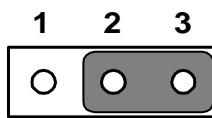

Table 4.6:

+12 V_{DC} (max. 500 mA)



4.2.4 Mini-PCle Socket Function Selection (SW2)

Table 4.7: Mini-PCle Socket Function Selection (SW2)

	SW2.1
WLAN	OFF
WWAN	ON

Default Setup on WLAN

4.2.5 Mini-PCle Socket Voltage Adjustment Level (SW3)

Setting MiniPCle Socket(CN33) Adjustment 3.3 Voltage level Max to 3.6V

Table 4.8: Mini-PCle Socket Function Selection (SW3)

	SW3.1	SW3.2	
3.3V	OFF	OFF	Standard MiniPCle Voltage
3.4V	ON	OFF	Reserved
3.5V	OFF	ON	Support WWAN Module MC809X
3.6V	ON	ON	Reserved

Default Setup on Standard MiniPCle(3.3V)

4.2.6 WWAN Socket Voltage Adjustment Level (SW4)

Setting WWAM Socket(CN32) Adjustment 3.3 Voltage level Max to 3.6V

Table 4.9: Mini-PCle Socket Function Selection (SW4)

	SW4.1	SW4.2	
3.3V	OFF	OFF	Standard MiniPCle Voltage
3.4V	ON	OFF	Reserved
3.5V	OFF	ON	Support WWAN Module MC809X
3.6V	ON	ON	Reserved

Default Setup on Support MC809X (3.5V)

4.2.7 COM Port Interface

The computer provides ten serial ports in total for different uses. Six of the ten serial ports (COM1~COM6) are implemented via the Super I/O chip and their physical address are fixed. The other four serial ports are via USB serial converter, and need driver support to work. Advantech provides WES (Windows Embedded Standard), WinXPe and Win CE 6.0 OS, the four USB-to-Serial serial ports are fixed from COM8 to COM11).

Table 4.10: Serial Port Function

Port	Function
COM1	2-wire RS-232 (TXD/RXD) for TREK-303
COM2	3-wire RS-232 (TXD/RXD/RTS) for Touch on TREK-303
COM3	Full functional RS-232 for GSM/GPRS
COM4	For power management control
COM5	4-wire RS-232 (TXD/RXD/RTS/CTS) for GSM/GPRS
COM6	2-wire RS-232 (TXD/RXD) for UPS
COM7	2-wire RS-232 (TXD/RXD) for GPS Module
COM8	RS485 for Camera PTZ control
COM9	Full functional RS-232 for DB9 connector
COM10	J1708 for DB15 connector
COM11	RS485 for HDC connector
COM12	Full functional RS-232 for HDC connector

Table 4.11: Serial Port Settings

Port	Address Range	Interrupt
COM1	2E8 ~ 2EF	4
COM2	2F8 ~ 2FF	3
COM3	3F8 ~ 3FF	5
COM4	3E8 ~ 3EF	7
COM5	2E0 ~ 2E7	10
COM6	2C0 ~ 2C7	10
COM7	2D0 ~ 2D7	11
COM8	2D8 ~ 2DF	11

Chapter 5

Pin Assignments

This chapter explains pin assignments on the TREK-668.

Sections include:

- Front/side Connector
- Power Connector
- Smart Display Connector
- RS232 Connectors
- DI/DO Connectors

5.1 Front Side Connectors









5.2 Rear Side Connectors







5.3 LED Indicator



	System Reset Button	Force the system to reboot
	Power Activity Indicator LED	When the system is in NORMAL mode, this LED will be lit up (Red Color)
	CF Activity Indicator LED	The storage activity indicator is a green LED, and flashes to show the activity of CF (Green Color)
	WLAN Activity Indicator LED	The WLAN activity indicator is a green LED, and flashes to show the activity of the WLAN module. (Green Color) This LED is controlled directly by the WLAN module.
	WWAN Activity Indicator LED	The WWAN activity indicator is a green LED, and flashes to show the activity of the WWAN module. (Green Color) This LED is controlled directly by the WWAN module.
	GPS Activity Indicator LED	The GPS activity indicator is a blue LED, and is used to show GPS activity This LED is controlled directly by the GPS chips. (Blue Color)
	Storage Activity Indicator LED	The storage activity indicator is a green LED, and flashes to show the activity of HDD/SSD.(Orange Color)

System power indicator LED

	Red LED Keep light Normal mode System is in NORMAL mode
	Red LED flashing Boot loader mode F/W can be update
	Orange LED Keep light Heater not workable Please Replace Heater
	Orange LED flashing Turn on Heater now

5.4 Power Connector (12/24V; 9 ~ 32V)

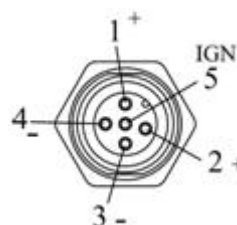

Connector type: M12 A-coding Jack GT234102-02050 female 5P

Table 5.1: Power Connector

Pin	Signal Depiction
1	Power Input (9 ~ 32 VDC)
2	Power Input (9 ~ 32 VDC)
3	Ground
4	Ground
5	Acc Ignition Input

5.5 CAN/J1708 Connector

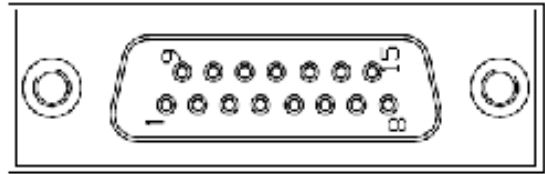

Connector type: 15P D-SUB female Connector

Table 5.2: CAN/J1708 Connector

Pin	Signal Depiction	Pin	Signal Depiction
1	CAN - H	9	J1708 - N
2	CAN - L	10	J1708 - P
3	CAN - Ground	11	J1708 - Ground
4	Isolation Digital Ground	12	DR - Speed - P
5	Isolation Digital Input 5	13	DR - Speed - N
6	Isolation Digital Input 6	14	DR - DIR - P
7	Isolation Digital Input 7	15	DR - DIR - N
8	Isolation Digital Input 8		

5.6 CAN / Video-In Connector

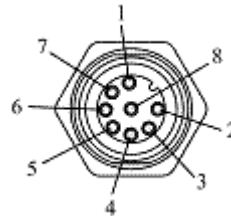

Connector type: M12 A-coding Jack GT234102-01080 female 8P

Table 5.3: CAN / Video-In Connector

Pin	Signal Depiction	Pin	Signal Depiction
1	LAN TRP0P	5	LAN TRP2N
2	LAN TRP0N	6	LAN TRP1N
3	LAN TRP1P	7	LAN TRP3P
4	LAN TRP2P	8	LAN TRP3N

5.7 HDC (High Density Connector) (CN27)



Connector type: D-SUB 50P 1.27 90D (Female) DIP Ribbon 10250-55G

Table 5.4: High Density Connector

Pin	Signal Depiction	Pin	Signal Depiction
1	+5 VDC output	26	+12 VDC output
2	+5 VDC output	27	+12 VDC output
3	Digital Ground	28	+12 VDC output
4	NC	29	Digital Ground
5	NC	30	Digital Ground
6	Digital Ground	31	Digital Ground
7	NC	32	RS232 RI#
8	NC	33	RS232 CTS#
9	Audio Ground	34	RS232 RTS#
10	Line-Out L	35	RS232 DSR#
11	Line-Out R	36	Digital Ground
12	Line-In R	37	RS232 DTR#
13	Line-In L	38	RS232 TXD
14	MIC In	39	RS232 RXD
15	Digital Ground	40	RS232 DCD#
16	RS485 P	41	NC
17	RS485 N	42	Isolation Digital Output 4
18	NC	43	Isolation Digital Output 3
19	NC	44	Isolation Digital Output 2
20	NC	45	Isolation Digital Output 1
21	NC	46	Isolation Digital Input 4
22	NC	47	Isolation Digital Input 3
23	NC	48	Isolation Digital Input 2
24	NC	49	Isolation Digital Input 1
25	NC	50	Isolation Ground

Note! +5 VDC output ($\pm 5\%$, Total max. 1A)



+12 VDC output ($\pm 5\%$, Total max. 1.5A)

5.8 Smart Display Connector

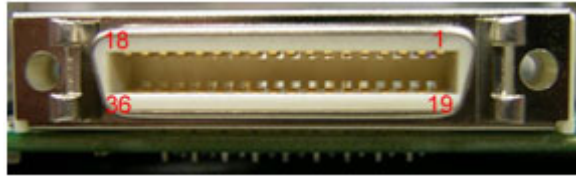

Table 5.5: Smart Display Connector

Pin	Signal	Pin	Signal
1	Backlight Enable output #	2	Panel Power Enable output #
3	LVDS Ground	4	Reset Button Input #
5	LVDS Clock +	6	LVDS Clock -
7	LVDS Ground	8	LVDS Ground
9	LVDS Data2 +	10	LVDS Data2 -
11	RS232 TXD1 #	12	RS232 RXD1 #
13	LVDS Data1 +	14	LVDS Data1 -
15	LVDS Ground	16	LVDS Ground
17	LVDS Data0 +	18	LVDS Data0 -
19	USB D-	20	USB D+
21	USB Ground	22	USB Ground
23	+12 V _{DC} output	24	+12 V _{DC} output
25	+12 V _{DC} output	26	+12 V _{DC} output
27	Power Ground	28	Power Ground
29	Power Ground	30	Power Ground
31	RS232 TXD2 #	32	RS232 RXD2 #
33	RS232 RTS2	34	Power Button Input #
35	Audio Ground	36	Mono. Line-out

Note! +12 VDC output ($\pm 5\%$, Total max. 1.5A)



5.9 VGA & RS-232 Connector (CN24)

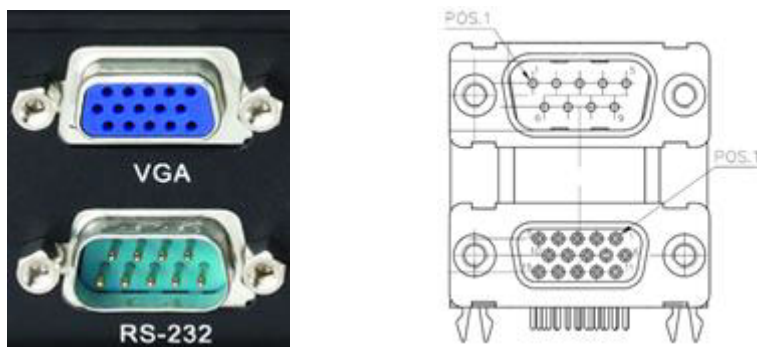

Connector type: D-SUB Conn. 9P+15P 90D (M/F) DIP DM10191-H551-4F

Table 5.6: RS232 Connector(COM9)

Pin	Signal Depiction	Pin	Signal Depiction
1	RS-232 DCD	5	RS-232 Ground
2	RS-232 RXD	6	RS-232 DSR
3	RS-232 TXD	7	RS-232 RTS
4	RS-232 DTR	8	RS-232 CTS
		9	RS-232 RI / +12 VDC output

Table 5.7: VGA Connector

Pin	Signal Depiction	Pin	Signal Depiction
1	CRT R	9	CRT POWER +5VDC($\pm 5\%$, max 1A)
2	CRT G	10	Ground
3	CRT B	11	NC
4	NC	12	CRT DDC_DATA
5	Ground	13	CRT HSYN
6	Ground	14	CRT VSYN
7	Ground	15	CRT DDC_CLK
8	Ground		

Note! Comport Connector +12 VDC output (+/- 5%, Total max 500mA)



5.10 Video Input Connector (CN25)

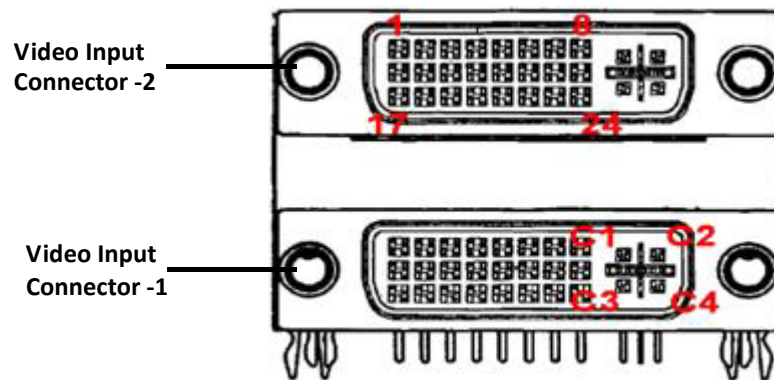

Connector type: DVI-I 29P/DVI-I 29P 1.905mm

Female right angle DIP C1DA2G2-020-R

Table 5.8: Video Input Connector 1

Pin	Signal Depiction	Pin	Signal Depiction
1	Video Input Channel 1	15	Digital Ground
2	Video Input Channel 2	16	Digital Ground
3	Video Input Channel 3	17	RS-485 N
4	Video Input Channel 4	18	RS-485 P
5	Audio Input Channel 1	19	Digital Ground
6	Audio Input Channel 2	20	Digital Ground
7	Audio Input Channel 3	21	Video Input Channel 5
8	Audio Input Channel 4	22	Video Input Channel 6
9	Digital Ground	23	Video Input Channel 7
10	Digital Ground	24	Video Input Channel 8
11	Digital Ground	C1	+12 VDC output
12	+12 VDC Output Enable#	C2	+12 VDC output
13	Digital Ground	C3	+12 VDC output
14	Digital Ground	C4	+12 VDC output

Table 5.9: Video Input Connector 2

Pin	Signal Depiction	Pin	Signal Depiction
1	Video Input Channel 9	15	Digital Ground
2	Video Input Channel 10	16	Digital Ground
3	Video Input Channel 11	17	RS-485 N
4	Video Input Channel 12	18	RS-485 P
5	Audio Input Channel 5	19	Digital Ground
6	Audio Input Channel 6	20	Digital Ground
7	Audio Input Channel 7	21	Video Input Channel 13
8	Audio Input Channel 8	22	Video Input Channel 14
9	Digital Ground	23	Video Input Channel 15
10	Digital Ground	24	Video Input Channel 16
11	Digital Ground	C1	+12 VDC output
12	+12 VDC Output Enable#	C2	+12 VDC output
13	Digital Ground	C3	+12 VDC output
14	Digital Ground	C4	+12 VDC output

Note! Per DVI Connector +12 VDC output (+/- 5%, Total max.2A)



5.11 Back USB Connector (CN23)

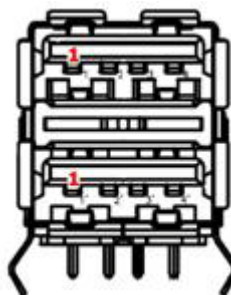

Connector type: Stack USB A-Type Receptacle DIP UB1112C-8FDE-4F

Table 5.10: USB Connector

Pin	Signal Depiction
1	Vcc
2	USB_Data-
3	USB_Data+
4	GND

5.12 Front USB Connector (CN21)

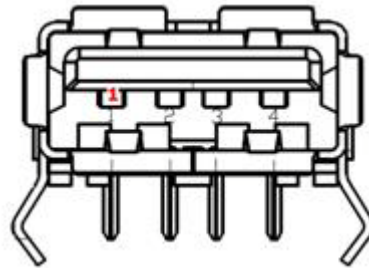

Connector type: Single USB A-Type Receptacle DIP UB1112C-4K1-4F

Table 5.11: USB Connector

Pin	Signal Depiction
1	Vcc
2	USB_Data-
3	USB_Data+
4	GND

Chapter 6

Software Demo Utility Setup

This appendix explains the software demo utility for TREK-668.

Sections include:

- Introduction
- How to Set up Demo Utility

6.1 Introduction

To make the hardware easier to access for programmers, Advantech has developed a demo utility in order to let customer test the functions on TREK-668. This document describes detailed information for each Advantech demo utility so that application developers can become more familiar with using them.

For technical support, contact Advantech application engineers worldwide. For news updates, visit our website: www.avanotech.com

6.1.1 Execute J1939 Demo Utility

This section explains how to install the Advantech demo utility in Windows XP Pro / Embedded.

1. Execute the test program called "IMC_Demo"



Figure 6.1 IMC demo utility

2. Click J1939: customer may connect directly to the truck; we use a car simulator board below to explain how J1939 protocol can be executed. First, connect to the simulator board to TREK-668 CAN port and console PC, once the simulator is powered on (connect to the truck), you can start getting the data, just click [Read], you may get the data you need from the car simulator, click [Read], you may transfer the data to Console.

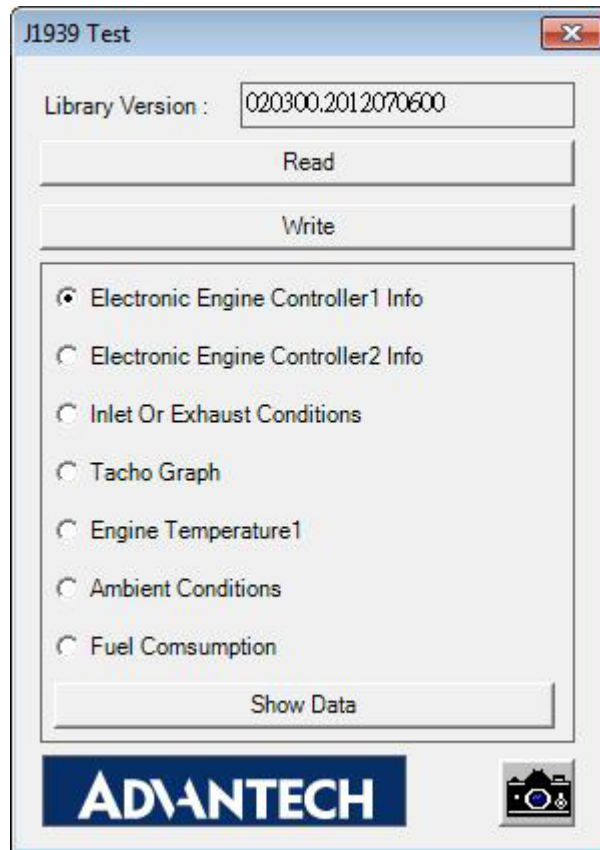

Figure 6.2 J1939 test - 1

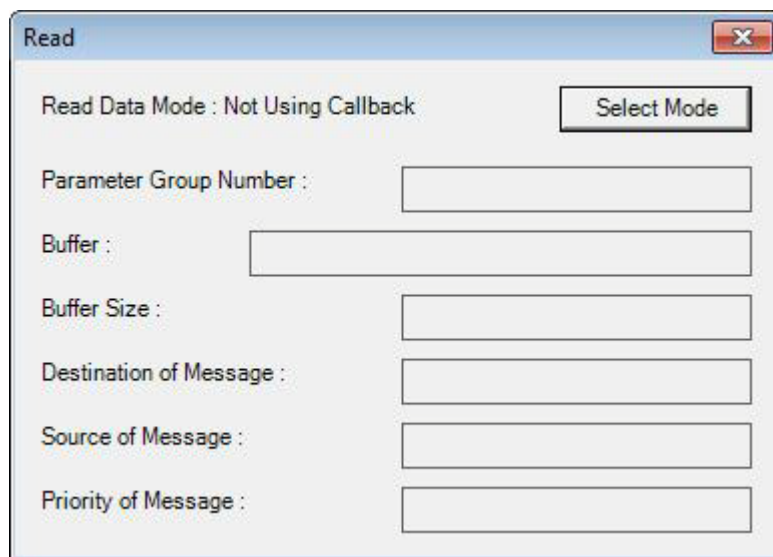

Figure 6.3 J1939 test - 2

6.1.2 Execute CAN Demo Utility

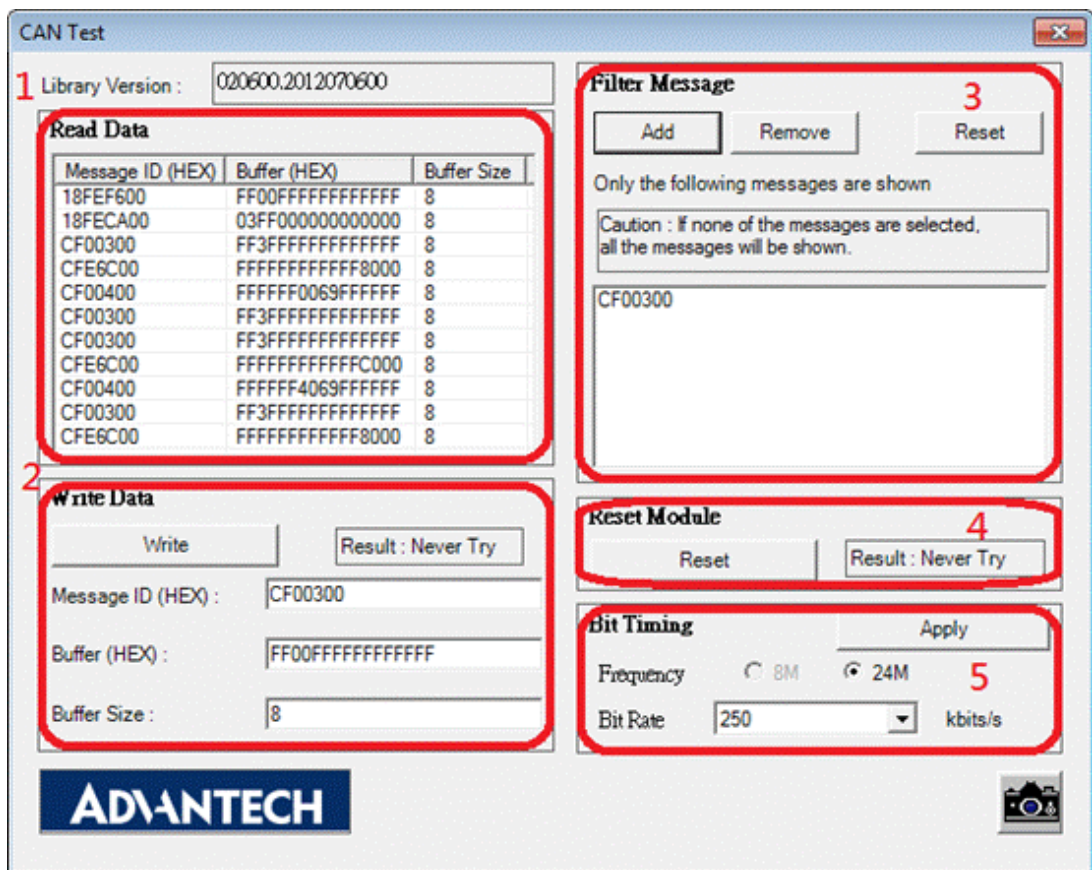

Figure 6.4 CAN test

1. Received CAN message.
2. Transmit CAN message
3. Set up the filter of CAN message (only show the message ID).
4. Reset the module.
5. Set the bit rate for CAN bus.

6.2 RTC Test

Execute "RTC test"

1. For RTC Time setting: You may set year, month, date, and time show as below.

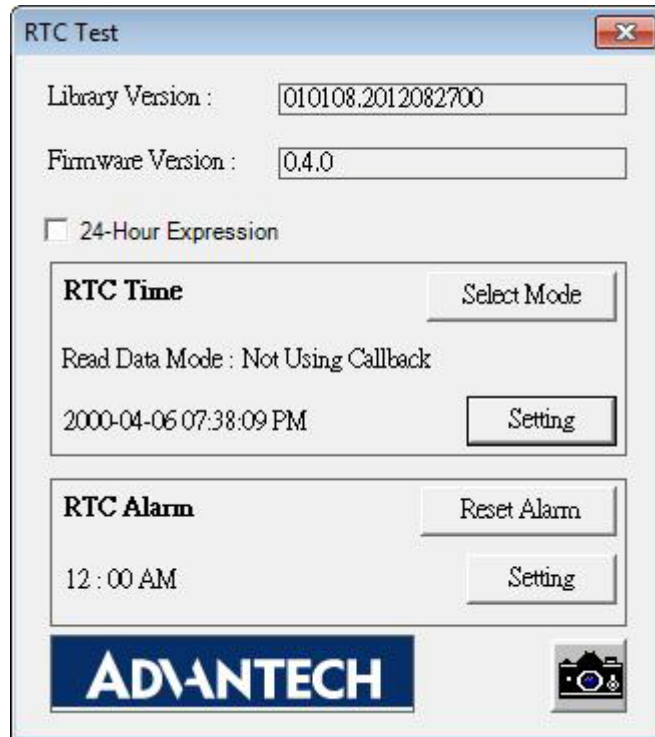

Figure 6.5 RTC test - 1

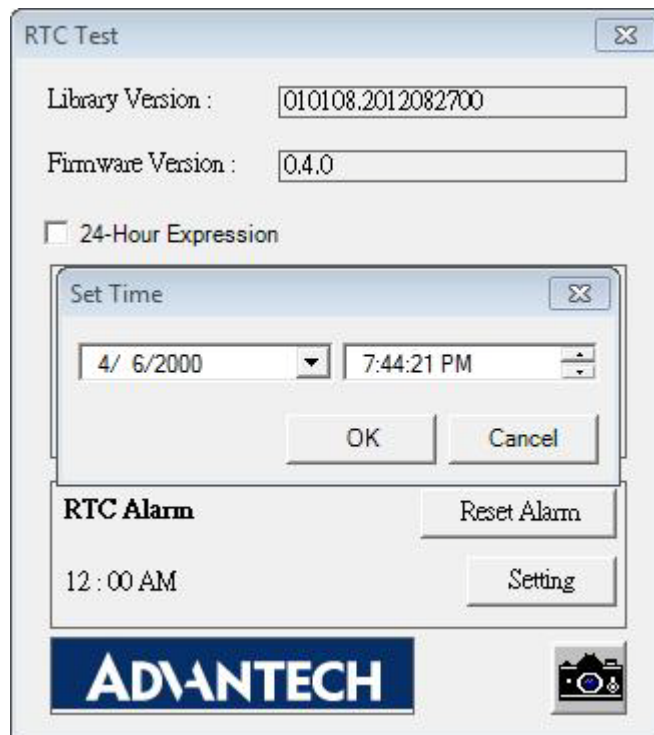

Figure 6.6 RTC test - 2

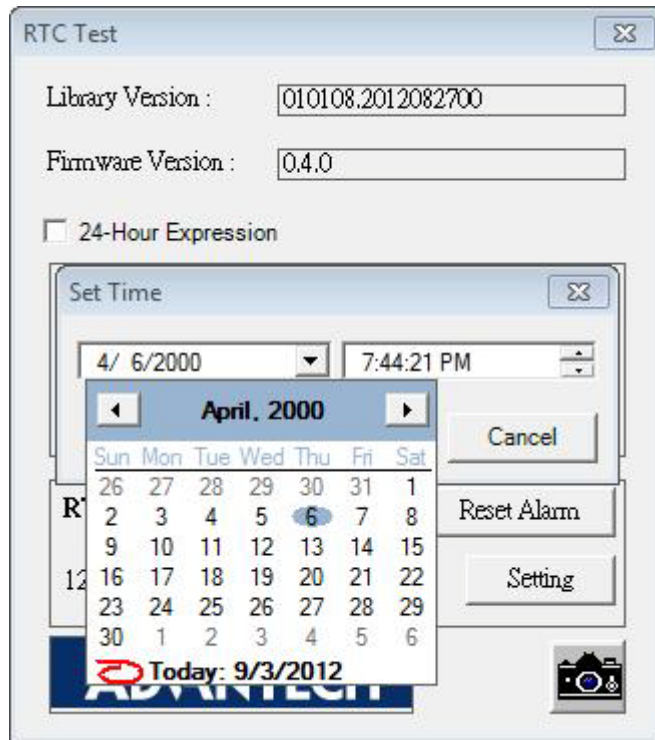

Figure 6.7 RTC test - 3

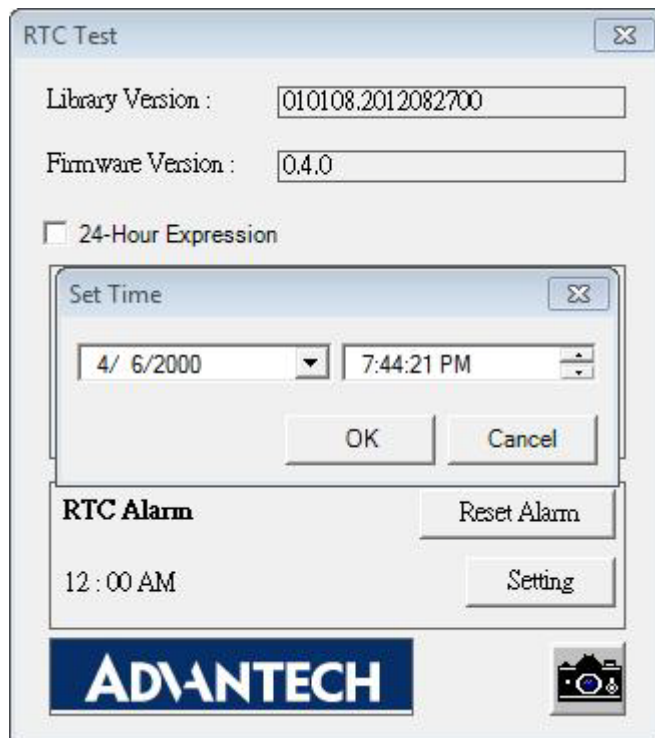

Figure 6.8 RTC test - 4

RTC Alarm Setting: You may also set Alarm time; you may wake up the system by the time you have set. Please refer to below figure 6.9.

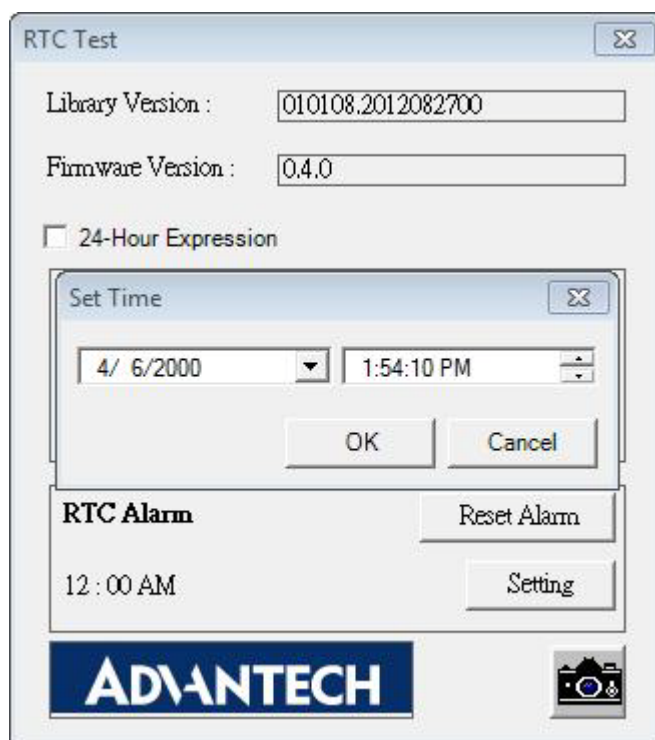

Figure 6.9 RTC test - 5

6.3 Vehicle Power Management

6.3.1 Power Management Mechanism

The feature of Vehicle Power Management (VPM) is provided for users to fulfill the special requirements on in-vehicle applications.

Ignition on/off

- Turn on the system by ignition
For the cases of in-vehicle applications, an ignition signal is often used to turn on or shutdown the system. When the system is in an OFF state and ignition is turn ON, the VPM controller will countdown ON_DELAY; once it counts to zero, the system will be turned on.
- Shutdown the system by ignition
When the system is powered on and the ignition is turn off, the OFF_EVENT_DELAY will start to count down. During this stage, if the ignition is back to ON, the VPM controller will stop countdown and reset the OFF_EVENT_DELAY value. If OFF_EVENT_DELAY counts to zero, the VPM controller will send an event (power button press) to the system and start to count HARD_OFF_DELAY. Application programs could watch this event to do pre-defined tasks, like storing data and preparing to turn off the system. Once going into the HARD_OFF_DELAY stage, this process will be irreversible. And if HARD_OFF_DELAY counts to zero, the system power will be cut off abruptly.

Low battery protection

To avoid draining out the car battery, low-battery protection is involved to ensure the car battery is capable to start the vehicle. When the system is ON, the VPM controller will monitor the car battery voltage. If the battery voltage is lower than a programmable threshold (LOW_THRESHOLD), the VPM controller will go into LOW_DELAY stage and start to count down. During the stage of LOW_DELAY countdown, if battery voltage is back above LOW_THRESHOLD, the VPM controller will stop counting down and exit. If LOW_DELAY counts to zero, the VPM controller will send an event (power button press) to notify the system, go into LOW_HARD_DELAY stage and start to count down. Once LOW_HARD_DELAY counts to zero, the VPM controller will cut off the system power abruptly to avoid draining out the car battery.

The table below lists the user programmable parameters for VPM features:

	Default value	Acceptable range
ON_DELAY	2 seconds	1 ~ 18000 seconds
OFF_EVENT_DELAY	5 seconds	1 ~ 18000 seconds
HARD_OFF_DELAY	60 seconds	1 ~ 18000 seconds
LOW_THRESHOLD (12V mode)	11.42 V	10.09 ~ 12.25 V
LOW_THRESHOLD (24V mode)	22.44 V	21.11 ~ 23.28 V
LOW_DELAY	30 seconds	1 ~ 3600 seconds
LOW_HARD_DELAY	60 seconds	1 ~ 3600 seconds

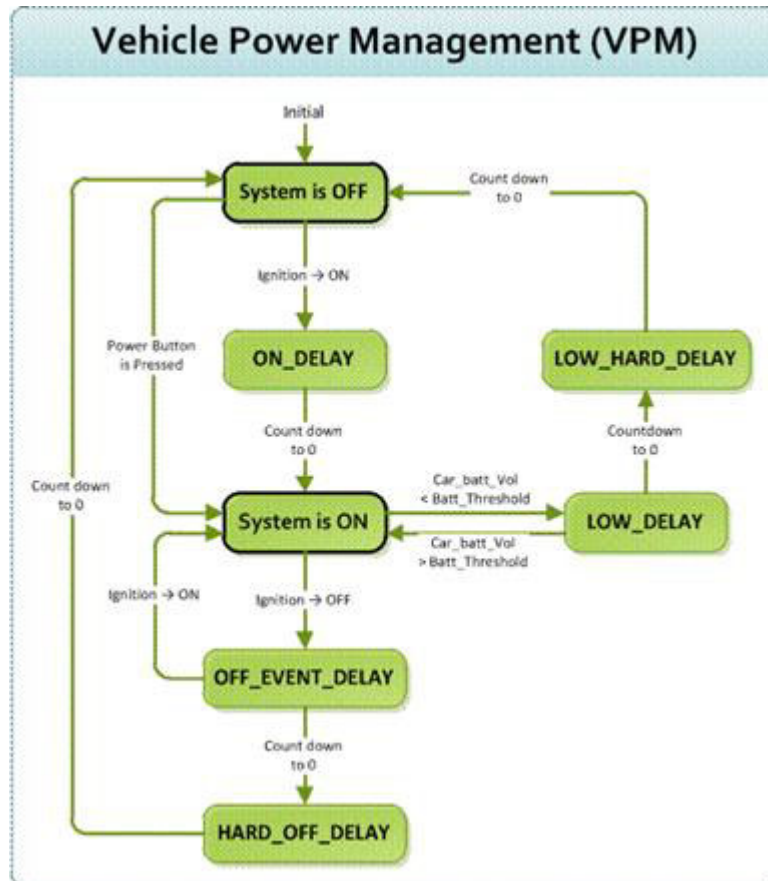

6.3.2 Power Management Utility Program

6.3.3 Power Management Parameter Settings

The parameters for power management on TREK-668 could be read or modified by Demo utility (see the image below) or SDK/API.

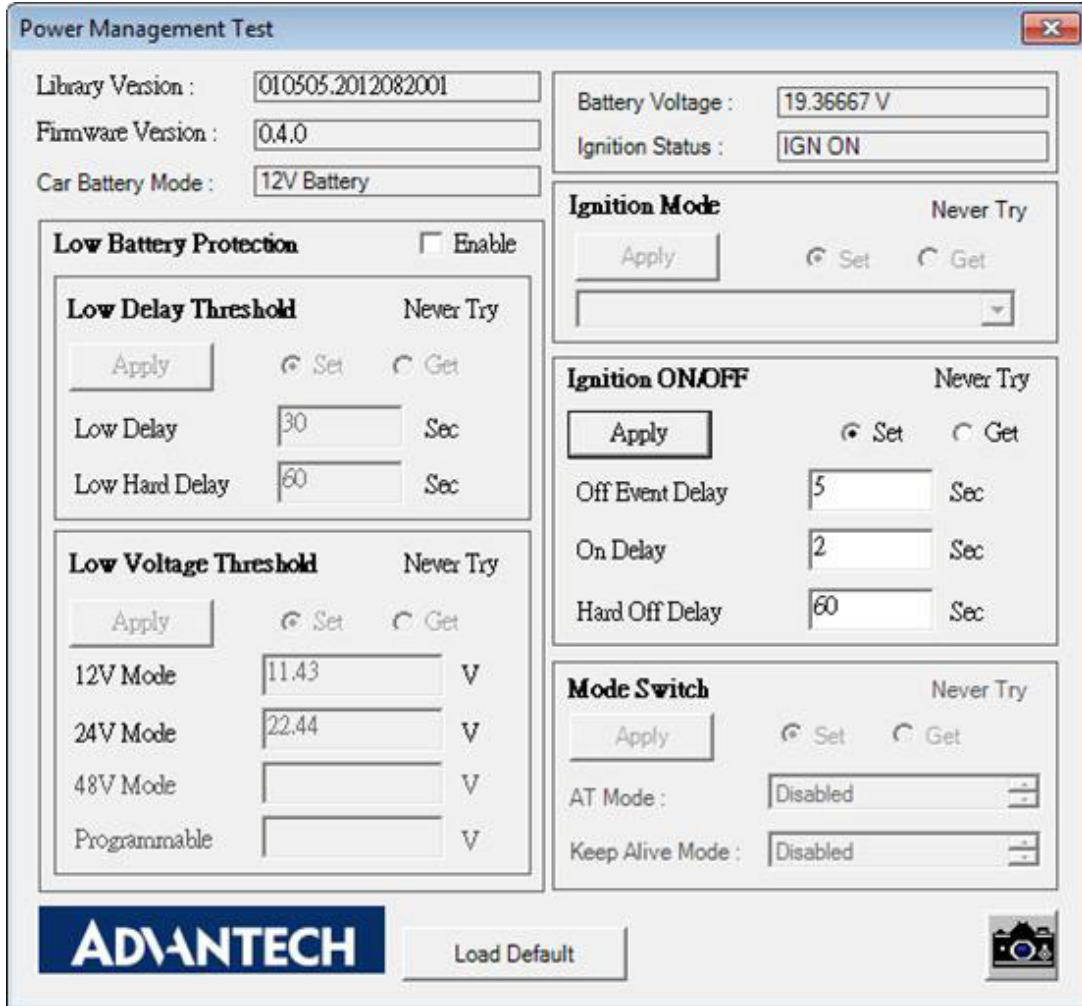

Figure 6.10 Power management test utility

6.3.4 TREK-668 Power Consumption

OS: Windows Embedded Standard; Test program: Burn-in test V6.0

Item	Test Condition	Test Case	Result
1	Full Loading Run BURN-IN 6.0	DC Input current (24V)	1.30 A
		Total Power (W)	32.4 W
2	Windows Idle	DC Input current (24V)	1.15 A
		Total Power (W)	27.6 W
3	Instant boot	DC Input current (24V)	1.15
		Total Power (W)	27.6 W
4	Windows Idle (Enable Heater)	DC Input current (24V)	1.80A
		Total Power (mW)	43.2 W
5	TREK S5	DC Input current (12V)	2.53 mA
		Total Power (mW)	30.36 mW

6.4 Digital IO Test

- To execute the I/O Test, connect DIO loopback, click Pin0, connect the end which reads the signal, the bulb should light up, like wise to Pin1~Pin3. Next check the Digital output box to execute the same procedure. See figure 6.

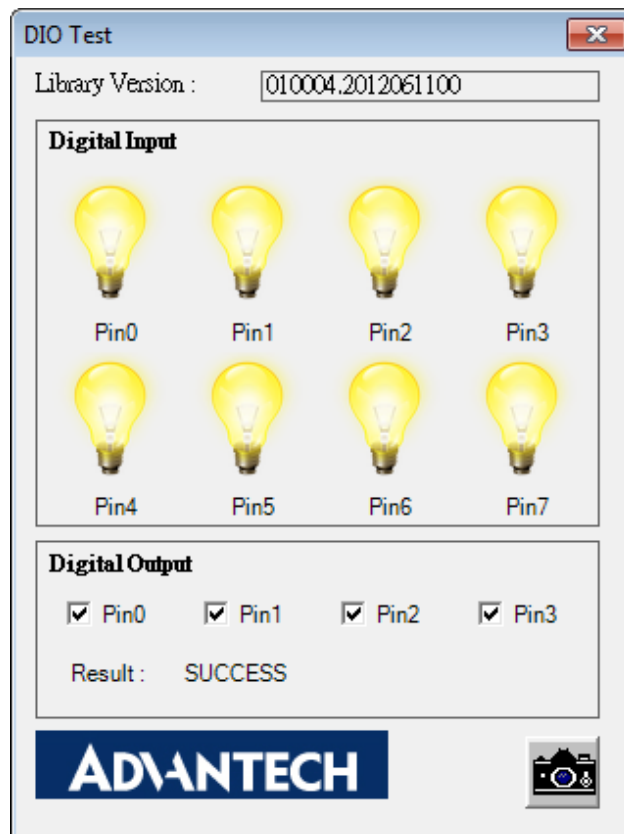

Figure 6.11 DI/O test

a. Digital Output ==> isolated relay driver output b. Digital Input ==> isolated dry contact input

For Digital In

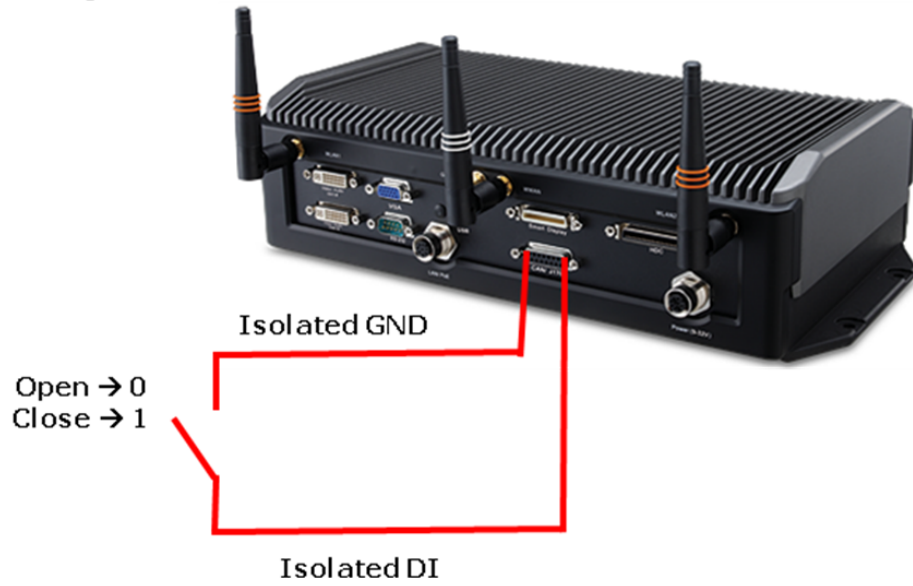
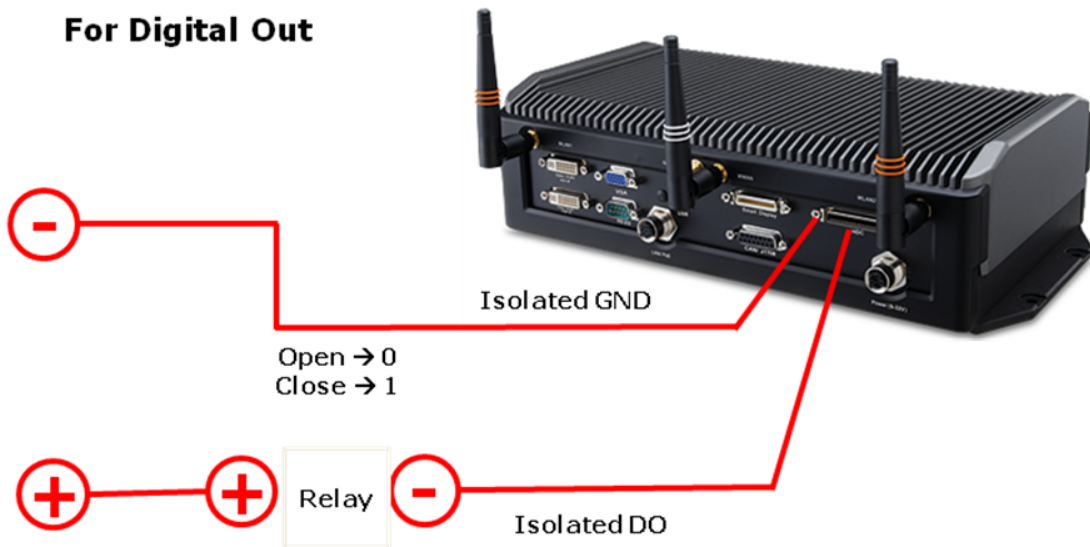

Figure 6.12 Digital in

For Digital Out



Do could control 150mA Relay without over wheeling diode

Figure 6.13 Digital out (Need Ned to create this picture for TREK-668)

6.5 Video in Test

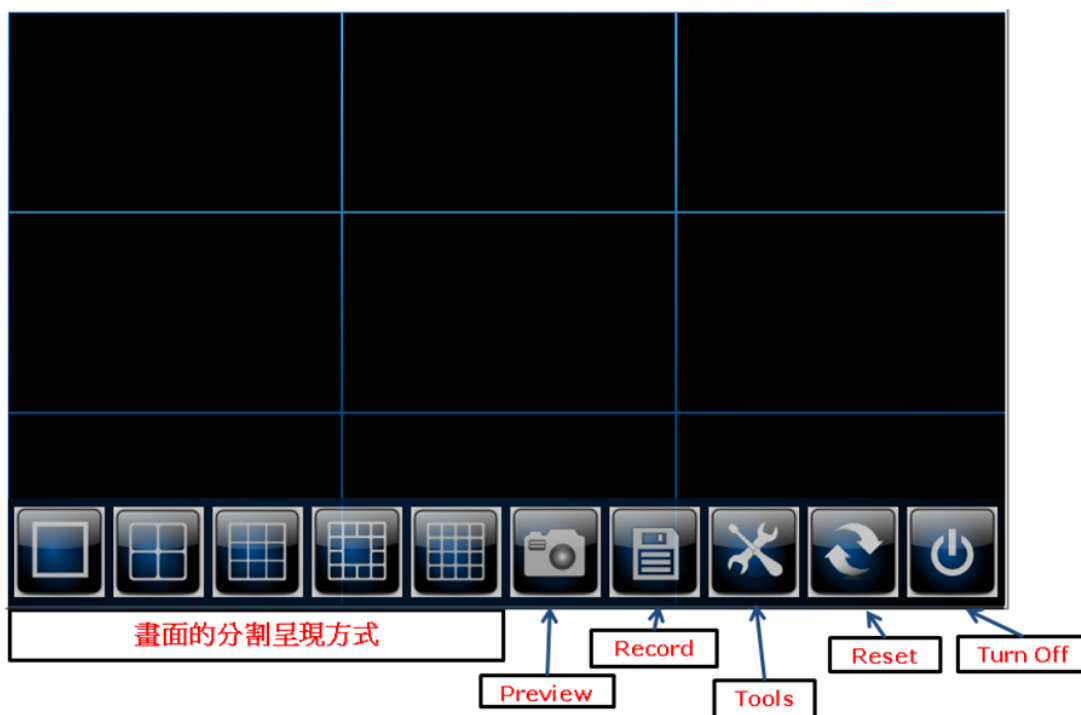

Figure 6.14 Video test utility

6.6 Dead Reckoning

Dead reckoning (DR) supplements GPS satellite position information with heading and distance data provided by additional sensors. When GPS satellites are out of sight, location is extrapolated using distance and angle information from the sensors. DR enables accurate navigation even in locations with poor or absent GPS signals such as tunnels, indoor parking facilities and deep urban canyons. In addition, DR effectively eliminates the impact of multi-path effects in urban canyon environments.

6.7 G-sensor (3-axis Accelerometer)

A 3-axis accelerometer is integrated in TREK-668. This could be used to characterize driver behavior such as hard accelerations, braking, and cornering. This also can tell users other significant information that can be used in accident reconstruction etc. A code example is provided for customer reference regarding how to access and configure G-sensor. G-sensor is located on the motherboard inside the TREK-668. Please refer the link(http://www.analog.com/static/imported-files/data_sheets/ADXL345.pdf) for the G-sensor datasheet.

6.8 Core Function

IMC SDK provides a simple API to set and get the basic hardware data. You may use these APIs to get the HW basic information, platform name, BIOS version etc.

User can also use core function API to easily understand read/write counting times, and bootup time, etc.

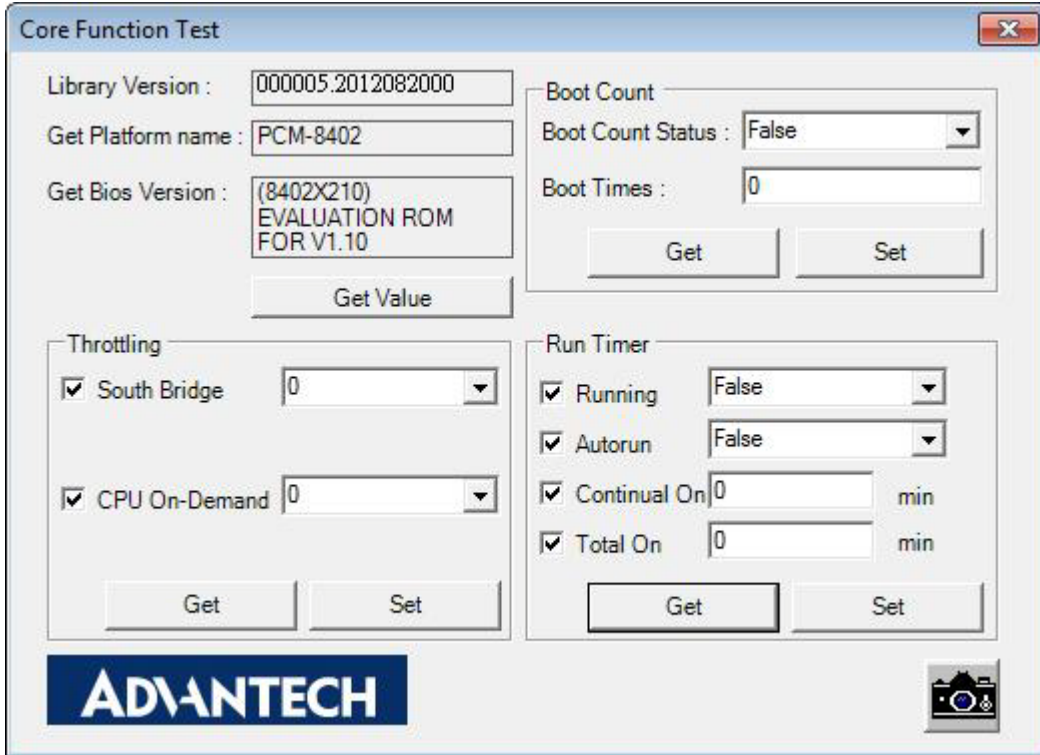

Figure 6.15 Core Function test

6.9 SMBus & I2C Control

The test includes 2 main items, one is system bus and the other is read/write I2C bus. When you need to access system and I2C bus, you may use these APIs.

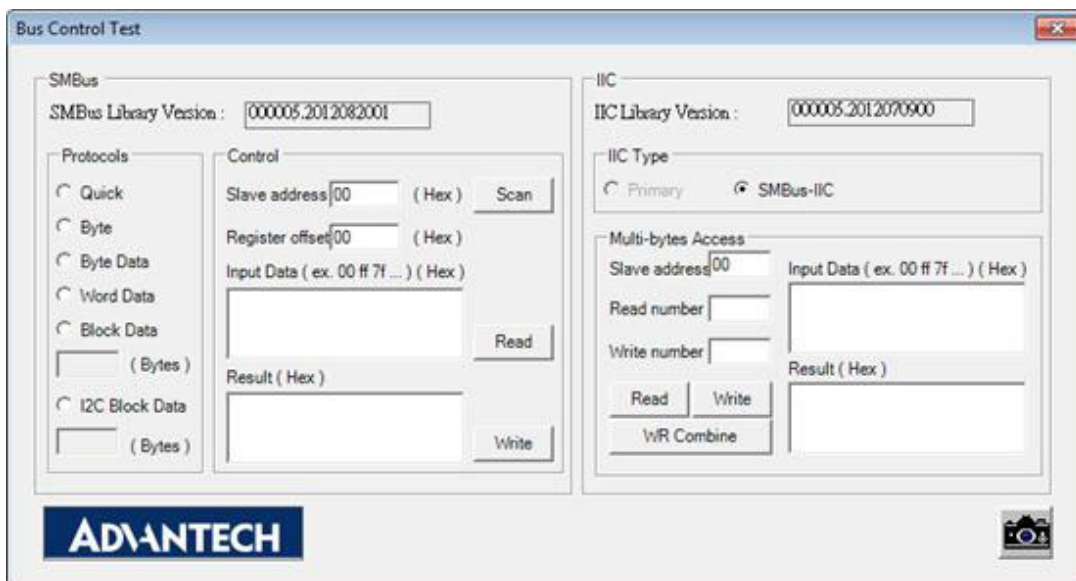

Figure 6.16 Core Function test

6.10 Hardware Monitor

Hardware monitor APIs provide some figures on M/B, these data includes voltage, temperature, etc.

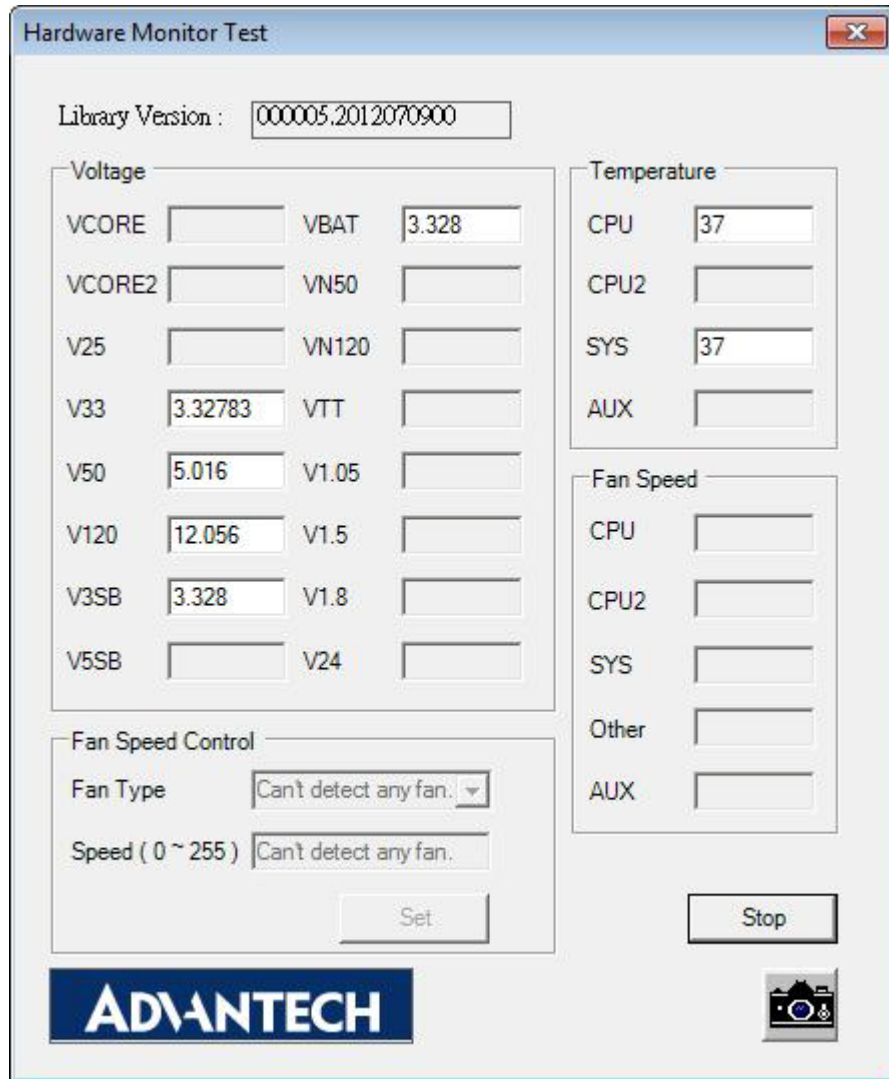

Figure 6.17 Hardware Monitor test

6.11 Peripheral Control

When you want to operate open /close on HW components, you may use this API to set or read/get the status. On TREK-668, you may use this API to operate BT, GPS, WWAN (3G), WLAN and CAN enable/disable. If you want to read hardware component status, you may use this API to get the current status.



Figure 6.18 Peripheral Control test

6.12 Roaming Control

TREK-668 supports dual WWAN, user can use this API to control SIM card and WWAN matching status.

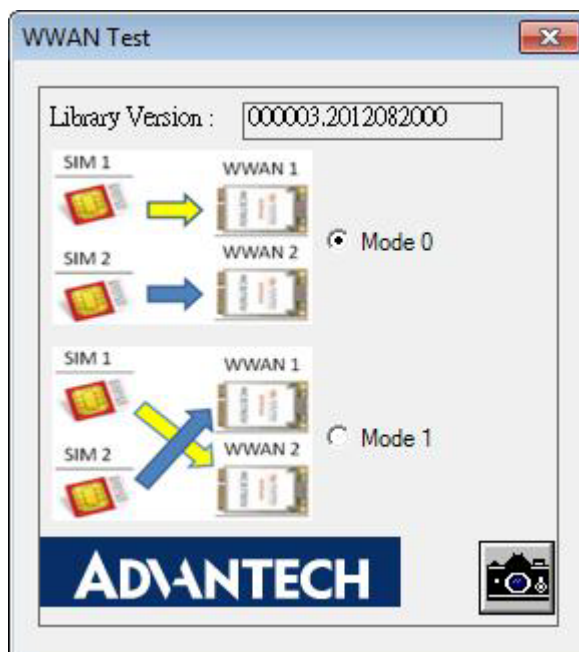
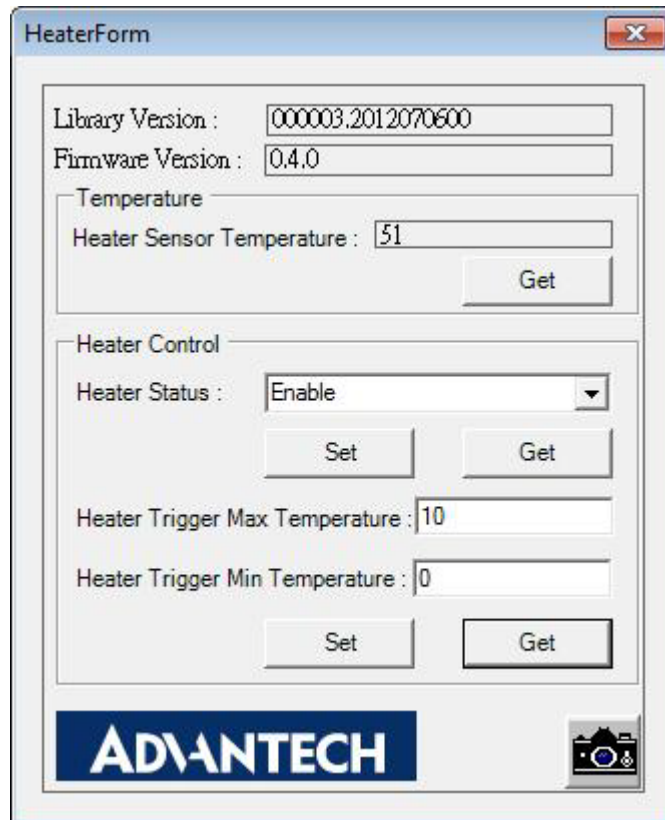

Figure 6.19 Roaming Control test

6.13 Heater

TREK-668 has a heater to cope with extremely low temperature. User can use this API to control the heater operation status, and allow user to enable and stop the temperature setting. When user would like to know the heater sense temperature, you can use this API to read the temperature.



The screenshot shows a software window titled "HeaterForm" with a close button in the top right corner. The window contains the following fields and controls:

- Library Version : 000003.2012070600
- Firmware Version : 0.4.0
- Temperature section:
 - Heater Sensor Temperature : 51
 - Get button
- Heater Control section:
 - Heater Status : Enable (dropdown menu)
 - Set button
 - Get button
 - Heater Trigger Max Temperature : 10
 - Heater Trigger Min Temperature : 0
 - Set button
 - Get button
- ADVANTECH logo at the bottom left.
- A small camera icon at the bottom right.

Figure 6.20 Heater test

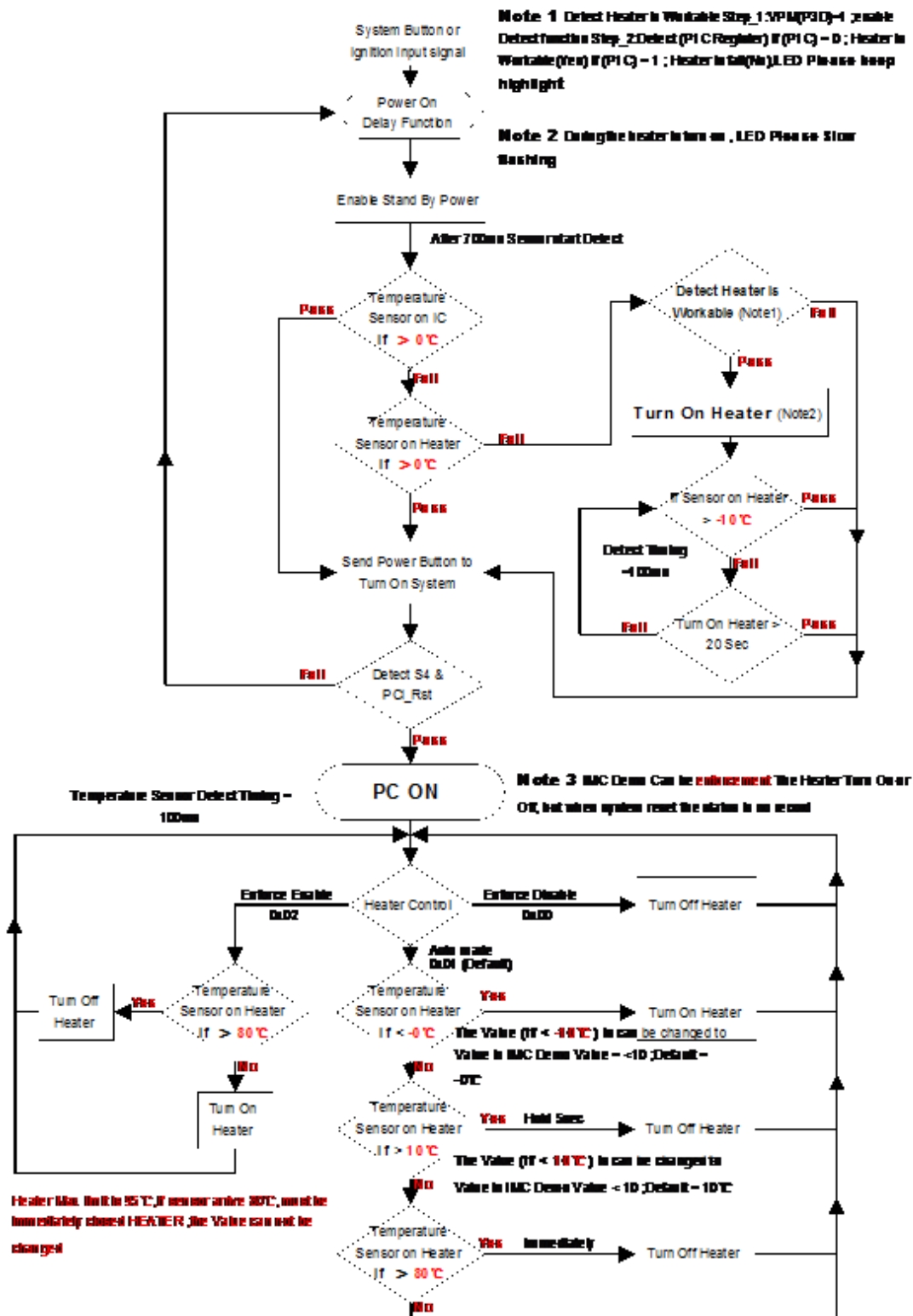

6.14 Altimeter

TREK-668 has integrated altimeter in our product. User can use this API to set altimeter operation status and the pressure value which pressure sensor reads. User can base on altimeter spec to transfer into the height of the vehicle.



Figure 6.21 Altimeter test

6.15 Watch Dog

IMC SDK provides a simple WatchDog function. When watchdog is enabled, if the user doesn't trigger the counting within the timing you set, watchdog will force to boot up. This function can prevent TREK-668 from hanging up in unexpected condition. User needs to set a time, and enable the sensor in the program during the time you set to prevent the system hang up in special condition.

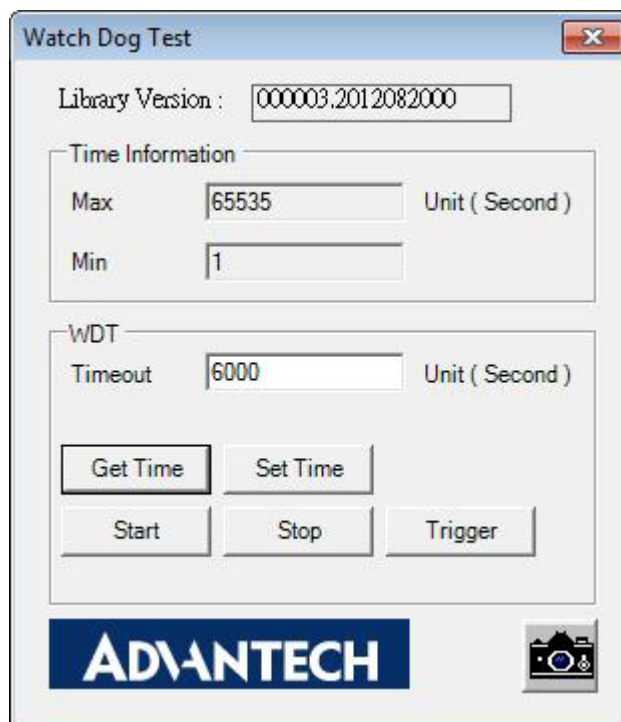

Figure 6.22 Watch Dog test

Appendix **A**

TREK-303

This appendix explains the TREK-303 detailed information.

A.1 Paired with TREK-303 Specifications

Table A.1: TREK-303 Specification

	Models	TREK-303R-DA0E	
	Design compatible models	Paired with TREK-668	
	Resolution (pixel)	800 x 480	
	Number of colors	262 K (supports 24-bit)	
Display	Pixel pitch	0.2168(H) x 0.2168 (V)	
	Brightness (cd/m ²)	500 (typical) without touchscreen	
	View angle (R/L/B/T)	70°/70°/60°/60°	
	Contrast ratio	500	
	Lamp life (hrs)	50,000 (min)	
	Lamp type	LED	
	Touchscreen	Touchscreen	4-wire resistive (GFG 4-wire design reserve)
	Front plane	Speaker	2 watts
Hotkey		Supports 5 hotkeys (user defined)	
Brightness control		Support Auto-dimming	
USB host		x 1	
Back plane	Smart display connector	x 1	
Power	DC input	12 V ± 5%	
	Power Consumption	~ 12W(Max.) ~ 4W (Normal.)	
Mechanical	Mounting	Design compatible with RAM mount	
	Material	PC	
	Weight	0.76 kg	
	Dimensions	212.75 x 141.85 x 35 mm	
	IP rating	IP54 (without I/O connector)	
Environment	Operating temperature	-30 ~ +70° C	
	Storage temperature	-40 ~ +80° C	
	Vibration	MIL-STD-810F, SAE J1455 4.9. 4.2	

- Note!**  1. The Brightness control is adjusted by the auto light sensor in the front panel as default; it is also defined by button on the front panel by manual.
2. The color LCD display



A,B: Speaker D: Light sensor
C: User-defined hotkeys E: Reset power, USB host (side)

Pin out for TREK-303 LVDS connector

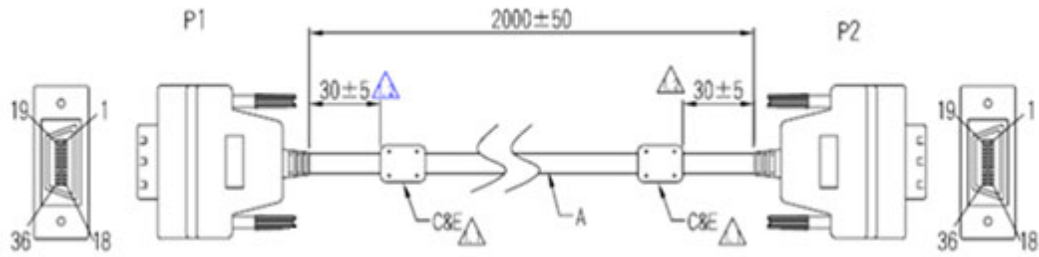

Table A.2: Smart Display Connector

Pin	Signal	Pin	Signal
1	Backlight Enable output #	2	Panel Power Enable output #
3	LVDS Ground	4	Reset Button Input #
5	LVDS Clock +	6	LVDS Clock -
7	LVDS Ground	8	LVDS Ground
9	LVDS Data2 +	10	LVDS Data2 -
11	RS232 TXD1 #	12	RS232 RXD1 #
13	LVDS Data1 +	14	LVDS Data1 -
15	LVDS Ground	16	LVDS Ground
17	LVDS Data0 +	18	LVDS Data0 -
19	USB D-	20	USB D+
21	USB Ground	22	USB Ground
23	+12 V _{DC} output	24	+12 V _{DC} output
25	+12 V _{DC} output	26	+12 V _{DC} output
27	Power Ground	28	Power Ground
29	Power Ground	30	Power Ground
31	RS232 TXD2 #	32	RS232 RXD2 #
33	RS232 RTS2	34	Power Button Input #
35	Audio Ground	36	Mono. Line-out

Note! +12 VDC output ($\pm 5\%$, Total max. 1.5A)





Pin assignment

P1	1	2	3	4	5	6	7	8	9	10	11	12	13	14	15	16	17	18
P2	1	2	3	4	5	6	7	8	9	10	11	12	13	14	15	16	17	18
Color	Brown	White	Ground	Brown	red	white	Ground	Ground	Orange	white	red	Orange	yellow	white	Ground	Ground	Green	white



19	20	21	22	23	24	25	26	27	28	29	30	31	32	33	34	35	36
19	20	21	22	23	24	25	26	27	28	29	30	31	32	33	34	35	36
Blue	white	Ground	yellow	Green	Blue	Purple	Grey	white	Black	Black	black	Orange	Black	Black	Black	Black	Black
										Brown	red		Yellow	green	blue	purple	grey



TREK-303 Hotkey Utility

Execute IMC demo utility



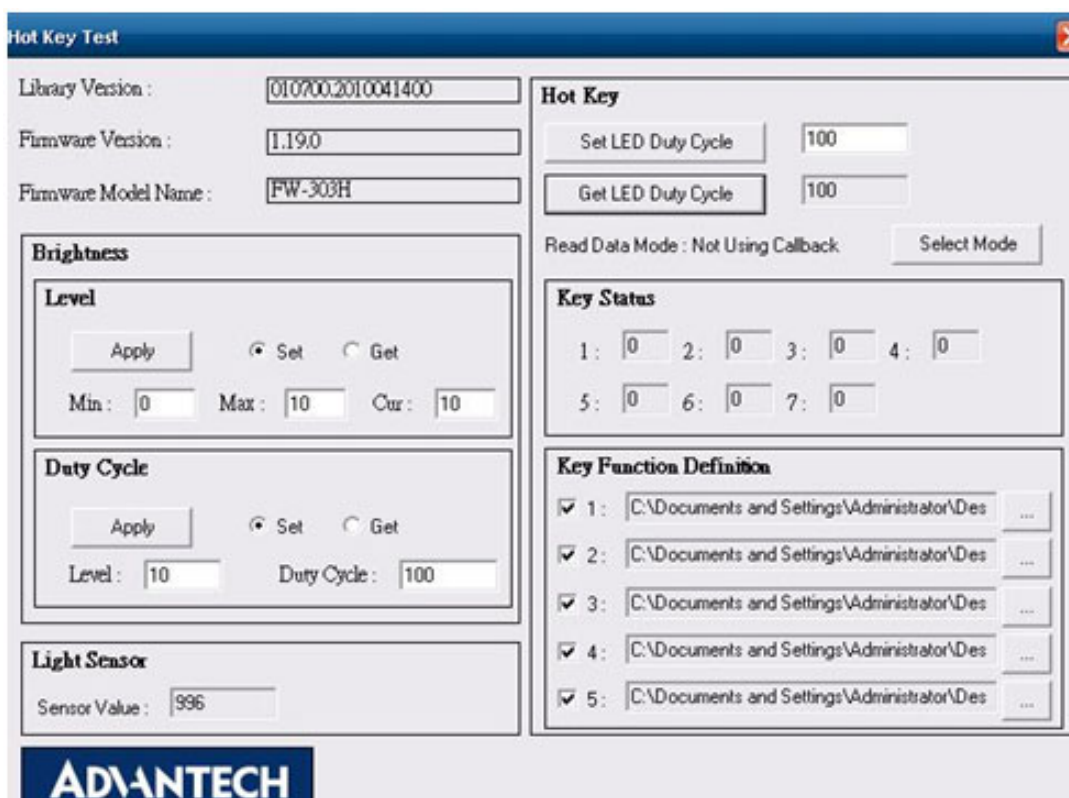
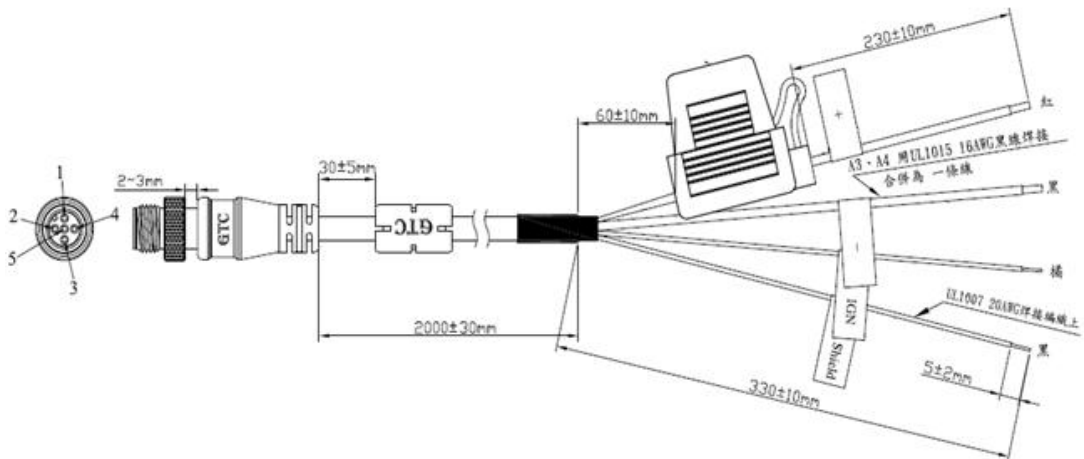
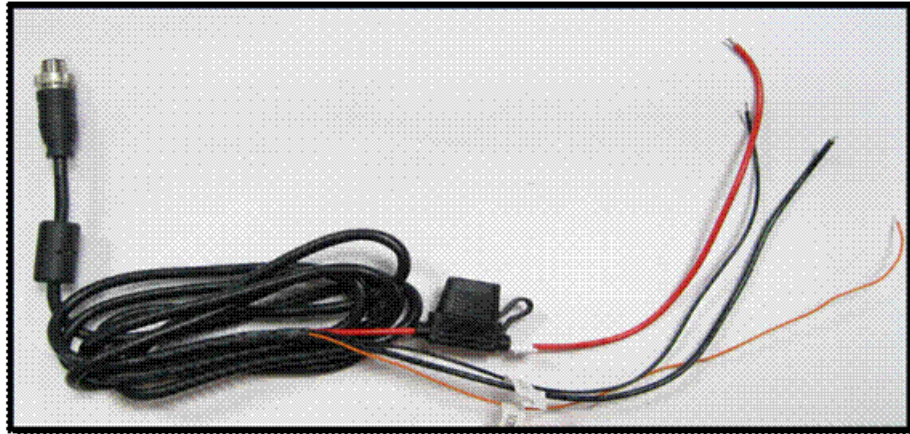

Figure A.1 Hotkey utility

1. Execute “Hot Key test” program →
2. Brightness level: You may set panel’s brightness from level 0 ~10, total 10 levels, when you finish setting the brightness level you want, please click “Apply”. If you want to check the current brightness level of TREK-303, please click “Get”.
3. Duty cycle: You may set every level’s brightness strength, total 10 levels, when you finish setting the brightness strength for each level, please click “Apply”. If you want to check the current brightness strength on certain level of TREK-303, please click “Get”.
4. Light sensor: When the sensor has detected the change of the brightness in the environment, the value will change. The lowest level of brightness, the lowest value it is presented. On the contrary, the highest level of brightness, the highest value it is presented.
5. Hotkey: the backlight brightness of hotkeys could be adjusted by setting the value from 0 ~100.
6. Key Status: When you press Hot key, the status will change from 0 to 1.
7. Key function Definition: You may set the parameter to connect the application program of the hot key.

A.2 TREK-668 Attached Cable Packet Indicator

Power M12 Jack Cable



Connector Type: M12 JACK GT238134-0205Z-JG-01 MALE 5P*1

Fuse Spec: 58V/7.5A*1

Table A.3: Power M12 JACK Cable Pin Depiction

PIN	Signal Depiction
1	Power Input (9 ~ 32 VDC)
2	Power Input (9 ~ 32 VDC)
3	Power Ground
4	Power Ground
5	Acc Ignition Input

A.3 LAN M12 Jack Cable

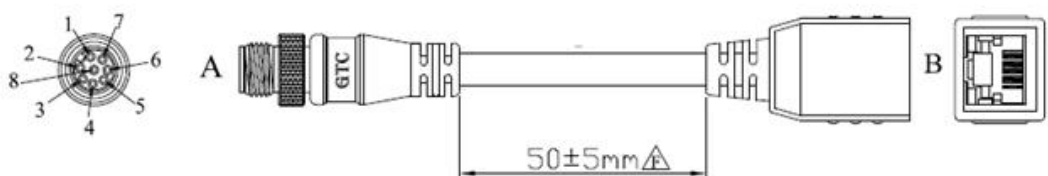

Connector Type: (M12 JACK GT234134-2108Z-JG-01 MALE 8P*1) (RJ45 WITHOUT LED*1)

Table A.4: LAN M12 JACK Cable Connector Pin Depiction

M12 JACK Connector		RJ45 Connector	
PIN	Signal Depiction	PIN	Signal Depiction
1	LAN TRP0P	1	LAN TRP0P
2	LAN TRP0N	2	LAN TRP0N
3	LAN TRP1P	3	LAN TRP1P
4	LAN TRP2P	4	LAN TRP2P
5	LAN TRP2N	5	LAN TRP2N
6	LAN TRP1N	6	LAN TRP1N
7	LAN TRP3P	7	LAN TRP3P
8	LAN TRP3N	8	LAN TRP3N

A.4 DB15 Cable

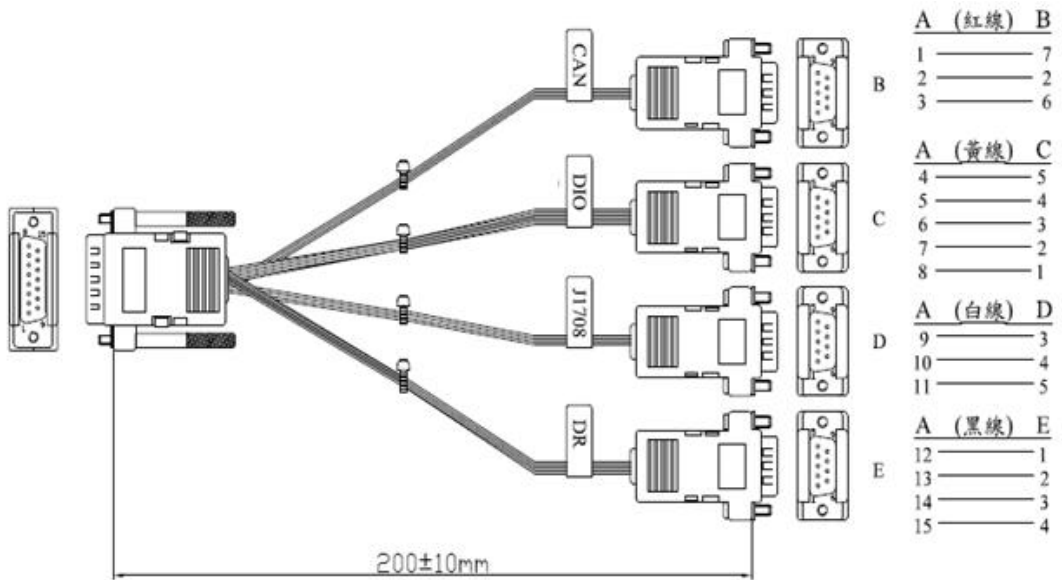
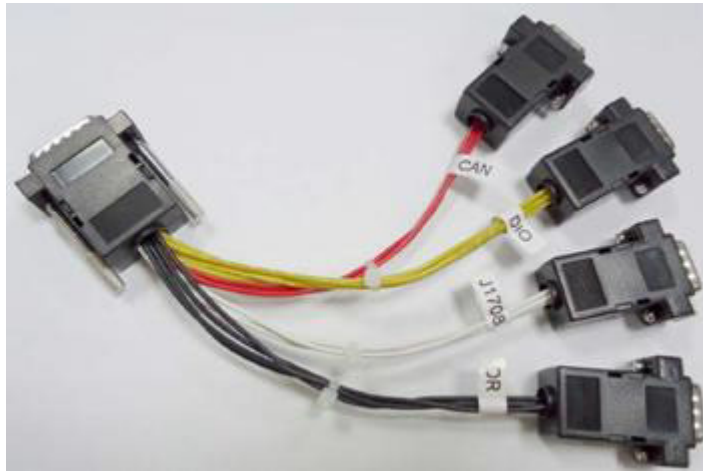

CONNECTOR TYPE: (D-SUB 15P MALE *1) (D-SUB 9PIN MALE*4)

Table A.5: DB15 Cable Connector Pin Depiction

B (RED LINE) (D-SUB 9PIN MALE)		C (YELLOW LINE) (D-SUB 9PIN MALE)		D (WHITE LINE) (D-SUB 9PIN MALE)		E (BLACK LINE) (D-SUB 9PIN MALE)	
CAN BUS		ISO-DI		J1708		DEAD RECKONING	
PIN	Depiction	PIN	Depiction	PIN	Depiction	PIN	Depiction
2	CAN_L	1	ISO_DI7	3	J1708_N	1	DR_SPEED_P
6	CAN_GND	2	ISO_DI6	4	J1708_P	2	DR_SPEED_n
7	CAN_H	3	ISO_DI5	5	J1708_GND	3	DR_DIR_P
		4	ISO_DI4			4	DR_DIR_n
		5	ISO_GND				

A.5 DVI Video Input Cable

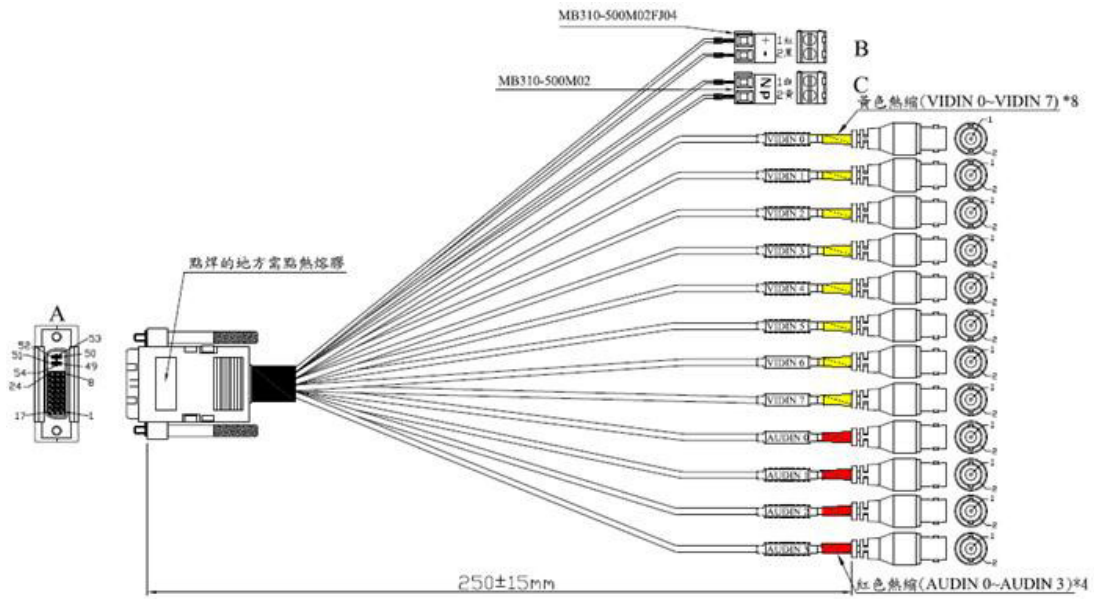

Table A.6: Video Input Cable Connector Pin Depiction							
B Terminal Block		C Terminal Block		D (YELLOW Label BNC)		E (RED Label BNC)	
Power Output		RS-485		VIDEO INPUT		AUDIO INPUT	
PIN	Depiction	PIN	Depiction	PIN	Depiction	PIN	Depiction
+	+12V / 2A	N	RS485-n	1	VIDEO INPUT	1	AUDIO INPUT
-	GND	P	RS485-p	2	GND	2	GND

A.6 HDC Cable

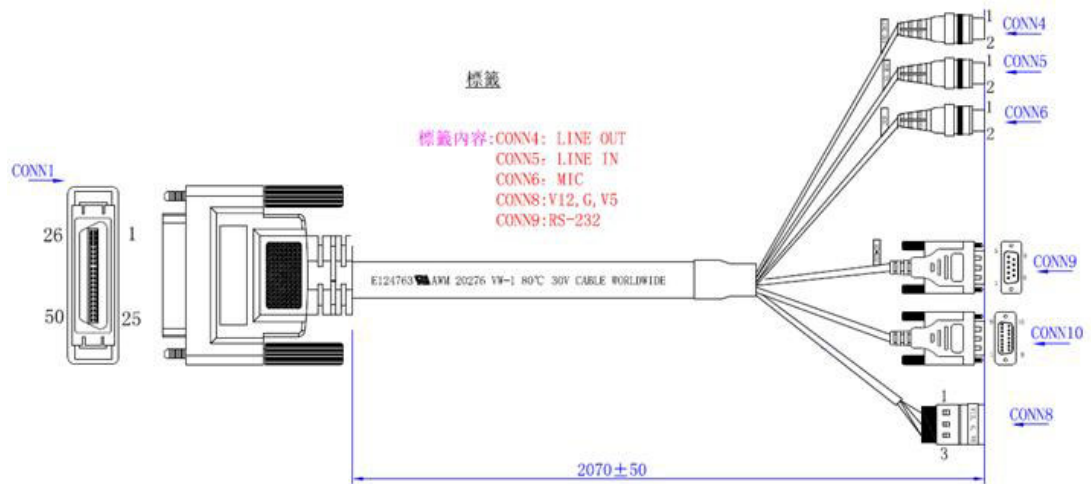

Table A.7: HDC Cable Pin Depiction

CONN4 (3.5 ⊕ PHONE JACK)		CONN5 (3.5 ⊕ PHONE JACK)		CONN6 (3.5 ⊕ PHONE JACK)		CONN8 (Terminal Block 3P)	
LINE OUT		LINE IN		VIDEO INPUT		Power Output	
PIN	Depiction	PIN	Depiction	PIN	Depiction	PIN	Depiction
1	LINE OUT-LEFT	1	LINE IN-LEFT	1	NC	1	+12V / 1A
2	LINE OUT-RIGHT	2	LINE IN-RIGHT	2	MIC IN	2	GND
						3	+5V / 1A

Table A.8: HDC Cable Pin Depiction

CONN9 (D-SUB 9P FEMALE)				CONN10 (D-SUB 15P FEMALE)			
RS232				ISO DIO & RS485			
PIN	Depiction	PIN	Depiction	PIN	Depiction	PIN	Depiction
1	RS232_DCD	6	RS232_DSR	1	ISO_DI1	10	ISO_DO2
2	RS232_RXD#	7	RS232_RTC	2	ISO_DI2	11	ISO_DO3
3	RS232_TXD#	8	RS232_CTS	3	ISO_DI3	12	ISO_DO4
4	RS232_DTR	9	RS232_RI	4	ISO_DI4	13	RS485_p
5	RS232_GND			5	ISO_GND	14	RS485_n
				9	ISO_DO1	15	RS485_GND

www.advantech.com

Please verify specifications before quoting. This guide is intended for reference purposes only.

All product specifications are subject to change without notice.

No part of this publication may be reproduced in any form or by any means, electronic, photocopying, recording or otherwise, without prior written permission of the publisher.

All brand and product names are trademarks or registered trademarks of their respective companies.

© Advantech Co., Ltd. 2013

