

MS-98J4

(v1.x) Industrial Computer Board



Copyright and Trademarks Notice

Copyright © Micro-Star Int'l Co., Ltd. All rights reserved. The MSI logo used is a registered trademark of Micro-Star Int'l Co., Ltd. All other marks and names mentioned may be trademarks of their respective owners. No warranty as to accuracy or completeness is expressed or implied. MSI reserves the right to make changes to this document without prior notice.

Revision History

Revision	Date
V1.0	2018/10

Technical Support

If a problem arises with your product and no solution can be obtained from the user's manual, please contact your place of purchase or local distributor. Alternatively, please visit <https://www.msi.com/support/> for further guidance.

Safety Instructions

- Always read the safety instructions carefully.
- Keep this User's Manual for future reference.
- Keep this equipment away from humidity.
- Lay this equipment on a reliable flat surface before setting it up.
- The openings on the enclosure are for air convection hence protects the equipment from overheating. **DO NOT COVER THE OPENINGS.**
- Make sure the voltage of the power source and adjust properly 110/220V before connecting the equipment to the power inlet.
- Place the power cord such a way that people can not step on it. Do not place anything over the power cord.
- Always Unplug the Power Cord before inserting any add-on card or module.
- All cautions and warnings on the equipment should be noted.
- Never pour any liquid into the opening that could damage or cause electrical shock.
- If any of the following situations arises, get the equipment checked by service personnel:
 - ▶ The power cord or plug is damaged.
 - ▶ Liquid has penetrated into the equipment.
 - ▶ The equipment has been exposed to moisture.
 - ▶ The equipment does not work well or you can not get it work according to User's Manual.
 - ▶ The equipment has dropped and damaged.
 - ▶ The equipment has obvious sign of breakage.
- **DO NOT LEAVE THIS EQUIPMENT IN AN ENVIRONMENT UNCONDITIONED, STORAGE TEMPERATURE ABOVE 60°C, IT MAY DAMAGE THE EQUIPMENT.**

Chemical Substances Information

In compliance with chemical substances regulations, such as the EU REACH Regulation (Regulation EC No. 1907/2006 of the European Parliament and the Council), MSI provides the information of chemical substances in products at:

https://www.msi.com/html/popup/csr/evmtprrt_pcm.html

Battery Information



European Union:

Batteries, battery packs, and accumulators should not be disposed of as unsorted household waste. Please use the public collection system to return, recycle, or treat them in compliance with the local regulations.



Taiwan:

For better environmental protection, waste batteries should be collected separately for recycling or special disposal.

廢電池請回收



California, USA:

The button cell battery may contain perchlorate material and requires special handling when recycled or disposed of in California.

For further information please visit:

<https://www.dtsc.ca.gov/hazardouswaste/perchlorate/>

Danger of explosion if battery is incorrectly replaced. Replace only with the same or equivalent type recommended by the manufacturer.

CE Conformity

Hereby, Micro-Star International CO., LTD declares that this device is in compliance with the essential safety requirements and other relevant provisions set out in the European Directive.



FCC-B Radio Frequency Interference Statement



This equipment has been tested and found to comply with the limits for a Class B digital device, pursuant to Part 15 of the FCC Rules. These limits are designed to provide reasonable protection against harmful interference in a residential installation. This equipment generates, uses and can radiate radio frequency energy and, if not installed and used in accordance with the instruction manual, may cause harmful interference to radio communications. However, there is no guarantee that interference will not occur in a particular installation. If this equipment does cause harmful interference to radio or television reception, which can be determined by turning the equipment off and on, the user is encouraged to try to correct the interference by one or more of the measures listed below:

- Reorient or relocate the receiving antenna.
- Increase the separation between the equipment and receiver.
- Connect the equipment into an outlet on a circuit different from that to which the receiver is connected.
- Consult the dealer or an experienced radio/television technician for help.

Notice 1

The changes or modifications not expressly approved by the party responsible for compliance could void the user's authority to operate the equipment.

Notice 2

Shielded interface cables and AC power cord, if any, must be used in order to comply with the emission limits.

This device complies with Part 15 of the FCC Rules. Operation is subject to the following two conditions:

- 1) this device may not cause harmful interference, and
- 2) this device must accept any interference received, including interference that may cause undesired operation.

WEEE Statement

Under the European Union ("EU") Directive on Waste Electrical and Electronic Equipment, Directive 2002/96/EC, which takes effect on August 13, 2005, products of "electrical and electronic equipment" cannot be discarded as municipal waste anymore and manufacturers of covered electronic equipment will be obligated to take back such products at the end of their useful life.



CONTENTS

Copyright and Trademarks Notice.....	ii
Revision History	ii
Technical Support.....	ii
Safety Instructions.....	iii
Chemical Substances Information	iv
Battery Information	iv
CE Conformity.....	v
FCC-B Radio Frequency Interference Statement	v
WEEE Statement	v
1. Overview.....	1-1
Specifications	1-2
Layout	1-6
Rear Panel I/O Options	1-7
2. Hardware Setup	2-1
Memory	2-3
Power Supply	2-4
Rear Panel I/O	2-5
Connector.....	2-7
Jumper	2-14
Slot.....	2-16
3. BIOS Setup.....	3-1
Entering Setup	3-2
The Menu Bar	3-4
Main	3-5
Advanced	3-6
Boot.....	3-12
Security	3-13
Chipset	3-21
Power.....	3-22
Save & Exit.....	3-24
Appendix GPIO WDT BKL Programming	A-1
Abstract	A-3
General Purposed IO	A-4
Watchdog Timer	A-5
LVDS Backlight Brightness Control.....	A-6
SMBus Access	A-7

1 Overview



Thank you for choosing the MS-98J4, an excellent industrial computer board.

Based on the innovative Intel® Kaby Lake/ Skylake Processor, the MS-98J4 is engineered to provide reliable performance for a wide variety of industrial applications.

Specifications

Processor

- Intel® Kaby Lake-U Core™ i7, Core™ i5, Core™ i3 Series Processor
- Intel® Skylake-U Core™ i7, Core™ i5, Core™ i3 Series Processor
- Intel® Kaby Lake-R Core™ i5 Series Processor

PCH

- Integrated with Processor

Memory

- 2 * DDR4 SO-DIMM slots
- Dual-Channel DDR4 Non-ECC memory up to 2133 MHz
- Max 32GB

Network

- 1 * Intel® I219LM GbE LAN PHY
- 1 * Intel® I211AT GbE LAN (Co-lay I210AT)

Storage

- 2 * SATA 6Gb/s ports
- 1 * M.2 Key M 2280 slot for SSD (Optional)
 - With SATA and PCIe signal
 - PCIe signal shared with PCIe x4 slot, auto switch by switch IC and PCIe x4 as top priority
- 1 * mSATA slot (shared with Mini-PCIe)

Audio

- Realtek ALC887 audio codec (Co-lay ALC888S)
- 1 * Line-Out jack
- 1 * Mic-In jack
- 1 * Amplifier header
- 1 * SPDIF header

Graphics

- Integrated Intel® HD Graphics
- 2 * LVDS 18/24 bit, Dual Channel
 - LVDS1 shared with eDP
 - LVDS2 shared with DP2/HDMI2.0
 - Max resolution 1920x1200@60Hz
- 1 * eDP
 - Shared with LVDS1
 - Max resolution 4096x2304@60Hz
- 2 * DP
 - DP1 shared with HDMI1.4
 - DP2 shared with LVDS2/HDMI2.0
 - Max resolution 4096x2160@60Hz, Default (Co-lay HDMI)
- 2 * HDMI
 - HDMI1.4 shared with DP1
 - HDMI2.0 shared with DP2
 - Max resolution 4096x2160@24Hz, Optional (Co-lay DP)
- 3 independent displays
 - LVDS1+DP1+DP2 (default)
 - LVDS1+DP1+HDMI2.0
 - LVDS1+LVDS2+DP1
 - LVDS1+LVDS2+HDMI1.4
 - LVDS1+HDMI1.4+DP2
 - LVDS1+HDMI1.4+HDMI2.0
 - eDP+DP1+DP2
 - eDP+DP1+HDMI2.0
 - eDP+LVDS2+DP1
 - eDP+LVDS2+HDMI1.4
 - eDP+HDMI1.4+DP2
 - eDP+HDMI1.4+HDMI2.0

Expansion Slot

- 1 * PCIe x4 slot
 - Signal shared with M.2 Key M, auto switch by switch IC and PCIe x4 as top priority
- 2 * Mini-PCIe slots
 - MPCIE/MSATA1 slot supports Mini-PCIe and mSATA cards
 - MINI_PCIE1 slot supports Mini-PCIe cards
- 1 * Nano SIM holder
- 1 * M.2 Key E 2230 slot for Wi-Fi/BT modules
 - With PCIe x1 and USB 2.0 signal

Rear Panel I/O

- 1 * DC power jack (Co-lay 4-pin power connector)
- 2 * DisplayPorts (Co-lay HDMI)
- 2 * GbE RJ45 ports
- 4 * USB3.0 ports
- 1 * Mic-In jack
- 1 * Line-Out jack

Internal I/O

- 1 * DC power connector (Optional)
- 1 * CPU fan header
- 1 * System fan header
- 2 * SATA 6Gb/s ports
- 2 * SATA power box headers
- 1 * Vertical USB2.0 connector (1 port) (Optional)
- 2 * USB2.0 headers (4 ports)
- 1 * Front panel header
- 1 * SPDIF header
- 1 * Amplifier header
- 1 * GPIO box header
- 1 * TPM header
- 1 * Chassis intrusion header
- 1 * Keyboard/Mouse box header
- 2 * RS232/422/485 serial port box headers (Optional)
- 2 * RS232 serial port box headers
- 2 * LVDS headers
- 2 * LVDS inverter box headers
- 1 * eDP connector
- 1 * SMBus box header
- 4 * Serial port power jumpers
- 2 * LVDS power jumpers
- 2 * LVDS inverter power jumpers
- 1 * eDP power jumper
- 1 * Clear CMOS jumper
- 1 * AT/ATX jumper
- 1 * LAN NVM jumper
- 1 * ME jumper

Form Factor

- 170 mm x 170 mm (6.7 x 6.7 inches, mini-ITX)

Environment

- Operating Temperature: -10 ~ 60°C
- Storage Temperature: -20 ~ 80°C
- Humidity: 10 ~ 90% RH, non-condensing

Accessories

- 1 * DC-in power cable (Max 12A supported)
- 1 * I/O shield
- 1 * SATA cable
- 1 * Driver CD

SKU Comparison

Features \ SKUs		SKU1	SKU2	SKU3
Processor		Intel Core™ i5-8250U	Intel Core™ i5-7300U	Intel Core™ i3-6100U
Graphics	Display	<ul style="list-style-type: none"> ■ eDP/LVDS1 ■ HDMI2.0/LVDS2 ■ HDMI1.4 	<ul style="list-style-type: none"> ■ eDP/LVDS1 ■ DP2/LVDS2 ■ DP1 	<ul style="list-style-type: none"> ■ LVDS1 ■ LVDS2 ■ DP1
	LVDS	2	2	2
	eDP	1	1	
	HDMI	2		
	DP		2	1
Expansion	PCIe x4	1	1	
	M.2 Key M 2280	1	1	
Rear I/O	LAN	2 (LAN1: i219, LAN2: i210)	2 (LAN1: i219, LAN2: i211)	1 (LAN2: i211)
	Power	DC jack	DC jack	4-pin connector
Internal I/O	Internal Vertical USB2.0	1	1	
	COM	4 (2 x RS232/422/485, 2 x RS232)	4 (2 x RS232/422/485, 2 x RS232)	2 (2 x RS232)

Layout

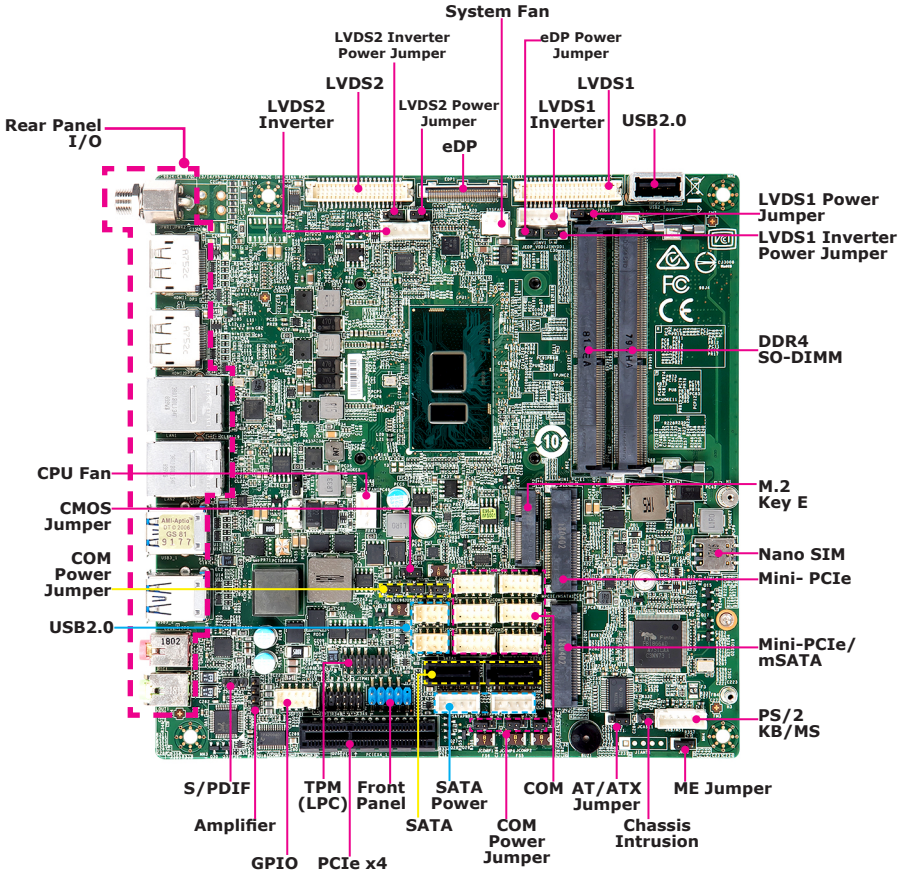

Rear Panel I/O Options

SKU1



SKU2



SKU3



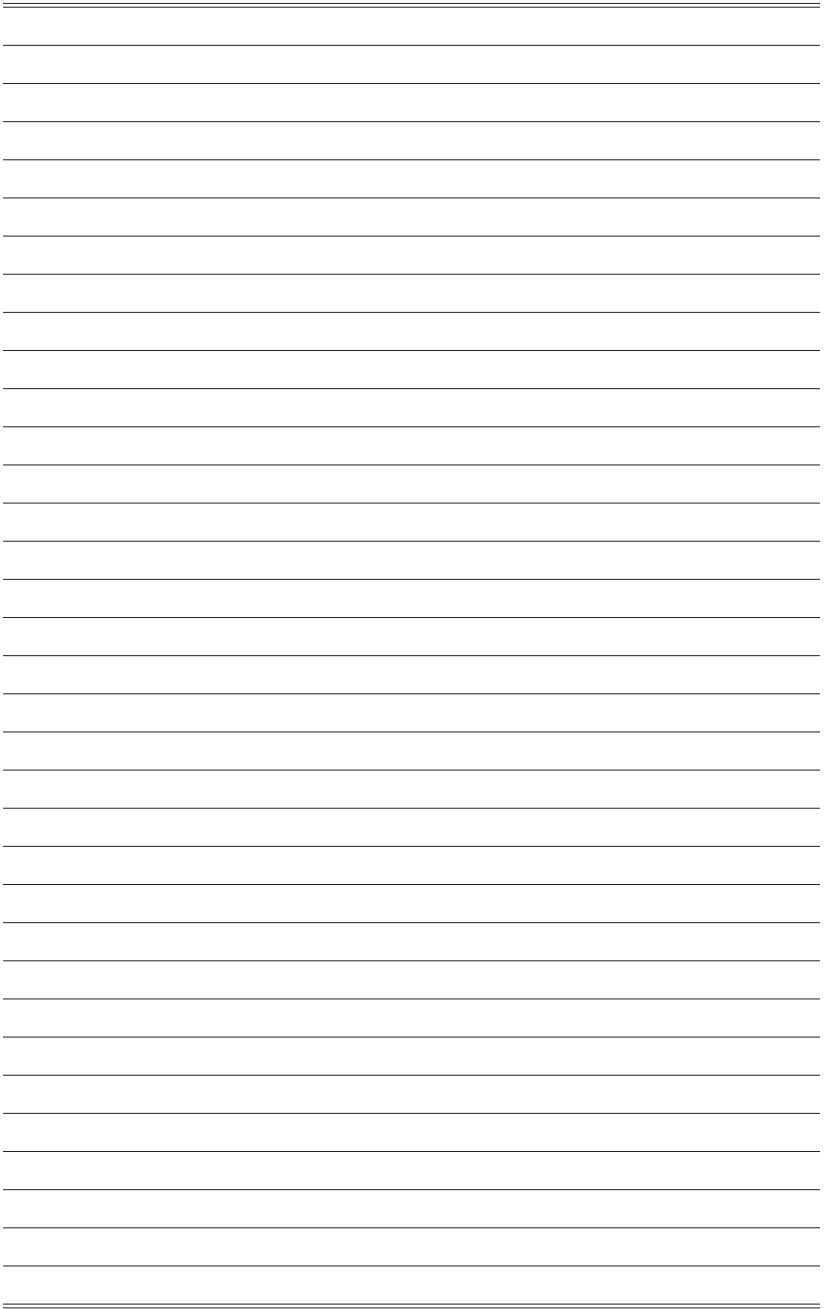

2 Hardware Setup



This chapter provides you with the information about hardware setup procedures. While doing the installation, be careful in holding the components and follow the installation procedures. For some components, if you install in the wrong orientation, the components will not work properly.

Use a grounded wrist strap before handling computer components. Static electricity may damage the components.

Components Reference Guide

Memory	2-3
Power Supply	2-4
DC Power Connector: JPWR2.....	2-4
SATA Power Connector: JSATAPWR1, JSATAPWR2.....	2-4
Rear Panel I/O	2-5
Connector	2-7
CPU Fan Power Connector: CPUFAN1	2-7
System Fan Power Connector: SYSFAN1	2-7
SMBus Connector: JSMB1	2-7
USB2.0 Connector: JUSB1, JUSB2, USB2	2-8
Serial ATA Connector: SATA1, SATA2.....	2-8
Front Panel Connector: JFP1.....	2-9
LPC Debug Port Connector: JTPM1	2-9
LVDS Inverter Connector: JINV1, JINV2.....	2-10
LVDS Connector: JLVDS1, JLVDS2.....	2-10
COM Port Connector: JCOM1 ~ JCOM6	2-11
Audio Amplifier Header: JAMP1	2-12
S/PDIF Header: JSPD1.....	2-12
Chassis Intrusion Header: JCASE1	2-12
PS/2 Keyboard/Mouse Connector: JKB/MS1.....	2-12
GPIO (DIO) Connector: JGPIO1	2-13
eDP Connector: EDP1	2-13
Jumper	2-14
Clear CMOS Jumper: JCMOS1	2-14
AT/ATX Jumper: JAT1	2-14
ME Jumper: JME1.....	2-14
eDP Power Jumper: JEDP_VDD1	2-14
JCOM1~JCOM2 Power Jumper: JCOMP1, JCOMP2	2-15
JCOM3~JCOM6 Power Jumper: JCOMP3 ~ JCOMP6	2-15
LVDS Power Jumper: JVDD1, JVDD2	2-15
LVDS Inverter Power Jumper: JINVDD1, JINVDD2.....	2-15
Slot	2-16
PCIe (Peripheral Component Interconnect Express) Slot.....	2-16
M2_M1: M.2 Slot (Key M, 2280) for SSD.....	2-16
M2_E1: M.2 Slot (Key E, 2230) for WiFi/BT.....	2-16
Mini-PCIe (Peripheral Component Interconnect Express) Slot.....	2-17
Nano SIM Holder.....	2-17

Memory

The SO-DIMM slot is intended for memory modules.

1. Locate the SO-DIMM slot. Align the notch on the DIMM with the key on the slot and insert the DIMM into the slot.

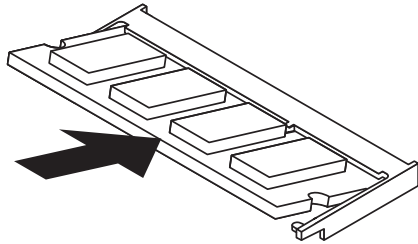

2. Push the DIMM gently downwards until the slot levers click and lock the DIMM in place.

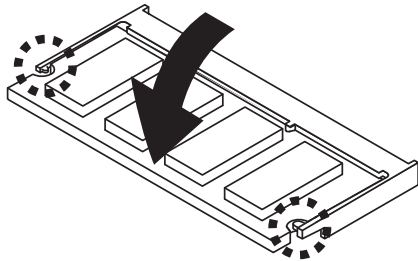

3. To uninstall the DIMM, flip the slot levers outwards and the DIMM will be released instantly.

Important

You can barely see the golden finger if the DIMM is properly inserted in the DIMM slot.

Power Supply

DC Power Connector: JPWR2

This connector allows you to connect a DC-in power cable.

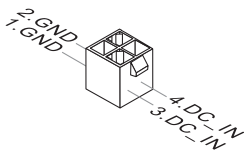

SATA Power Connector: JSATAPWR1, JSATAPWR2

This connector is used to provide power to SATA devices.

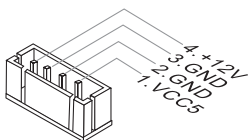

Important

- *Make sure all power connectors are connected to the power supply to ensure stable operation of the motherboard.*
- *Make sure that you hold the onboard power connector firmly before disconnecting the power cable.*

Rear Panel I/O

SKU1



DC Jack HDMI1.4 Port HDMI2.0 Port GbE RJ45 Ports USB3.0 Ports Mic-In Jack Line-Out Jack

SKU2



DC Jack DisplayPort DisplayPort GbE RJ45 Ports USB3.0 Ports Mic-In Jack Line-Out Jack

SKU3



DC-In Connector DisplayPort GbE RJ45 Port USB3.0 Ports Mic-In Jack Line-Out Jack

➤ DC Jack

This jack is used to provide power to the motherboard.

➤ HDMI Port

The High-Definition Multimedia Interface (HDMI) is an all-digital audio/video interface capable of transmitting uncompressed streams. HDMI supports all TV format, including standard, enhanced, or high-definition video, plus multi-channel digital audio on a single cable.

➤ DisplayPort

DisplayPort is a digital display interface standard. This connector is used to connect a monitor with DisplayPort inputs.

► GbE RJ45 Port

The standard single RJ45 LAN jack is provided for connection to the Local Area Network (LAN). You can connect a network cable to it.

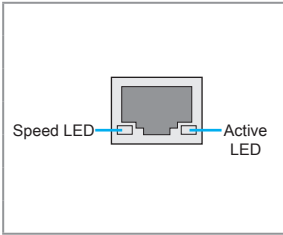
	LED	LED Status	Description
	Active LED	Off	No link
		Yellow	Linked
		Blinking	Data activity
	Speed LED	Off	10 Mbps connection
		Green	100 Mbps connection
		Orange	1 Gbps connection

► USB3.0 Port

The USB 3.0 port is backward-compatible with USB 2.0 devices and supports data transfer rate up to 5 Gbit/s (SuperSpeed).

► Mic-In Jack

For microphones.

► Line-Out Jack

For speakers or headphones.

Connector

CPU Fan Power Connector: CPUFAN1

The fan power connector supports CPU cooling fans with +12V. When connecting the wire to the connectors, always note that the red wire is the positive and should be connected to the +12V; the black wire is Ground and should be connected to GND. If the motherboard has a System Hardware Monitor chipset onboard, you must use a specially designed fan with speed sensor to take advantage of the fan control.

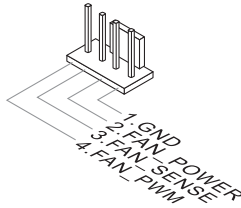

System Fan Power Connector: SYSFAN1

The fan power connectors support system cooling fan with +12V. When connecting the wire to the connectors, always note that the red wire is the positive and should be connected to the +12V; the black wire is Ground and should be connected to GND. If the motherboard has a System Hardware Monitor chipset onboard, you must use a specially designed fan with speed sensor to take advantage of the CPU fan control.

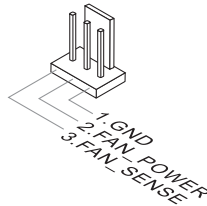

SMBus Connector: JSMB1

This connector, known as I2C, is for users to connect System Management Bus (SMBus) interface.

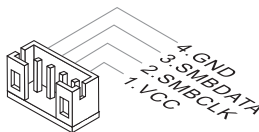

USB2.0 Connector: JUSB1, JUSB2, USB2

This connector is ideal for connecting USB devices such as keyboard, mouse, or other USB-compatible devices.

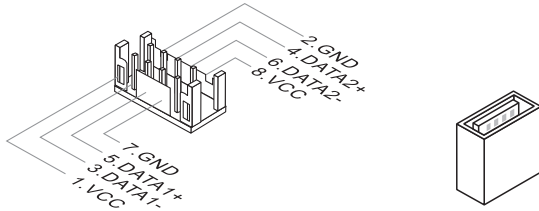

Important

Note that the pins of VCC and GND must be connected correctly to avoid possible damage.

Serial ATA Connector: SATA1, SATA2

This connector is a high-speed Serial ATA interface port. Each connector can connect to one Serial ATA device.

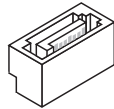

Important

Please do not fold the SATA cable into a 90-degree angle. Otherwise, data loss may occur during transmission.

Front Panel Connector: JFP1

This front panel connector is provided for electrical connection to the front panel switches & LEDs and is compliant with Intel Front Panel I/O Connectivity Design Guide.

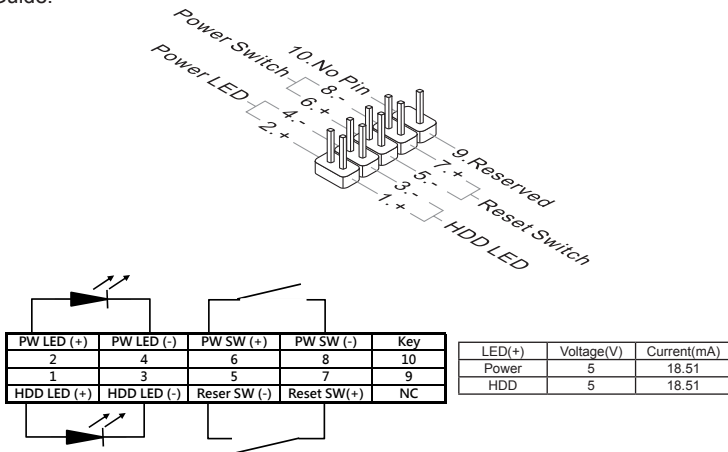

LPC Debug Port Connector: JTPM1

This connector works as LPC debug port and supports TPM modules.

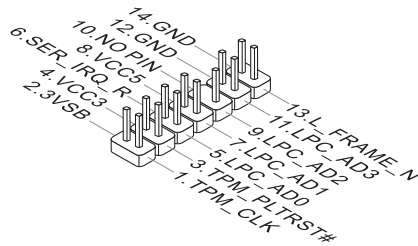

LVDS Inverter Connector: JINV1, JINV2

The connector is provided for LCD backlight options.

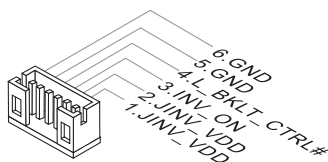

LVDS Connector: JLVDS1, JLVDS2

The LVDS (Low Voltage Differential Signal) connector provides a digital interface typically used with flat panels. After connecting the LVDS flat panel, be sure to check the panel datasheet and set the LVDS jumper to proper power voltage.

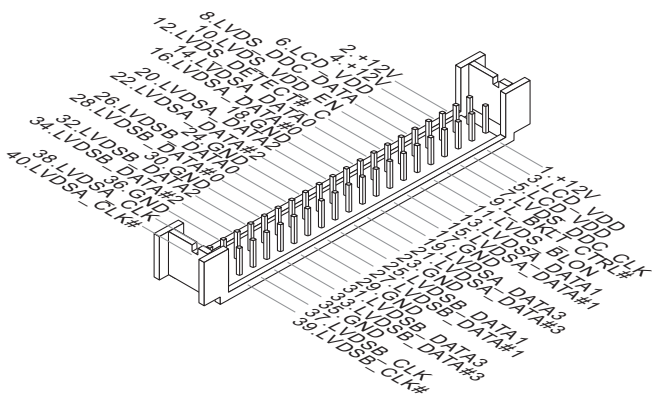

Important

Pin 12 is a detect pin. When using a customized LVDS cable, pin 12 should be a signal ground with a low impedance. Otherwise, LVDS will not function.

COM Port Connector: JCOM1 ~ JCOM6

This connector is a 16550A high speed communications port that sends/receives 16 bytes FIFOs. You can attach a serial device to it. JCOM1 and JCOM2 support RS232/422/485. JCOM3 ~ JCOM6 support RS232.

► JCOM1 ~ JCOM2

RS232

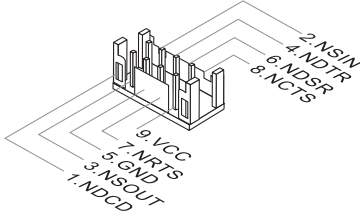

PIN	SIGNAL	DESCRIPTION
1	NDCD	Data Carrier Detect
2	NSIN	Signal In
3	NSOUT	Signal Out
4	NDTR	Data Terminal Ready
5	GND	Signal Ground
6	NDSR	Data Set Ready
7	NRTS	Request To Send
8	NCTS	Clear To Send
9	VCC	5V or 12V selected by jumper

RS422

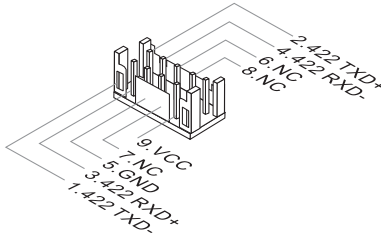

PIN	SIGNAL	DESCRIPTION
1	422 TXD-	Transmit Data, Negative
2	422 TXD+	Transmit Data, Positive
3	422 RXD+	Receive Data, Positive
4	422 RXD-	Receive Data, Negative
5	GND	Signal Ground
6	NC	No Connection
7	NC	No Connection
8	NC	No Connection
9	VCC	5V or 12V selected by jumper

RS485

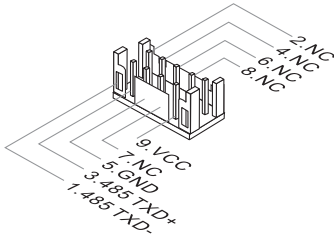

PIN	SIGNAL	DESCRIPTION
1	485 TXD-	Transmit Data, Negative
2	NC	No Connection
3	485 TXD+	Transmit Data, Positive
4	NC	No Connection
5	GND	Signal Ground
6	NC	No Connection
7	NC	No Connection
8	NC	No Connection
9	VCC	5V or 12V selected by jumper

► JCOM3 ~ JCOM6

RS232

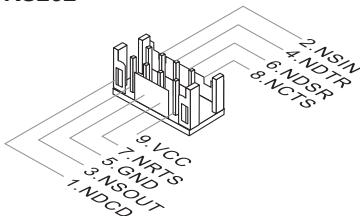

PIN	SIGNAL	DESCRIPTION
1	NDCD	Data Carrier Detect
2	NSIN	Signal In
3	NSOUT	Signal Out
4	NDTR	Data Terminal Ready
5	GND	Signal Ground
6	NDSR	Data Set Ready
7	NRTS	Request To Send
8	NCTS	Clear To Send
9	VCC	5V or 12V selected by jumper

Audio Amplifier Header: JAMP1

The connector is used to connect audio amplifiers to enhance audio performance.

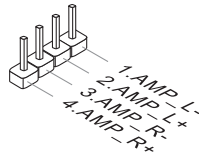

S/PDIF Header: JSPD1

This header is used to connect S/PDIF (Sony & Philips Digital Interconnect Format) interface for digital audio transmission.

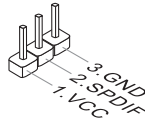

Chassis Intrusion Header: JCASE1

This connector connects to the chassis intrusion switch cable. If the computer case is opened, the chassis intrusion mechanism will be activated. The system will record this intrusion and a warning message will flash on screen. To clear the warning, you must enter the BIOS utility and clear the record.

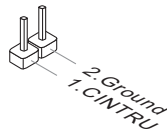

PS/2 Keyboard/Mouse Connector: JKB/MS1

This connector is provided to connect a keyboard and a mouse.

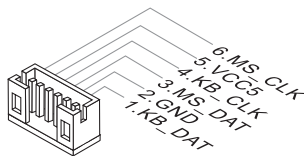

GPIO (DIO) Connector: JGPIO1

This connector is provided for the General-Purpose Input/Output (GPIO) peripheral module.

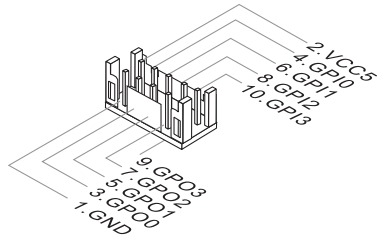

eDP Connector: EDP1

This connector is for connecting the flat eDP cable.

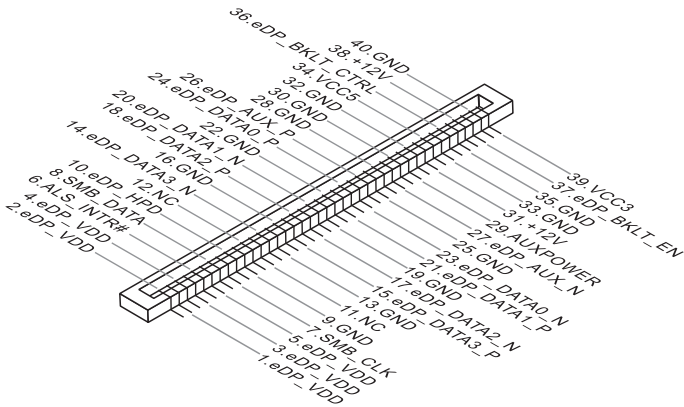

Jumper

Important

Avoid adjusting jumpers when the system is on; it will damage the motherboard.

Clear CMOS Jumper: JCMOS1

There is a CMOS RAM onboard that has a power supply from an external battery to keep the data of system configuration. With the CMOS RAM, the system can automatically boot OS every time it is turned on. If you want to clear the system configuration, set the jumper to clear data.



Important

You can clear CMOS by shorting 2-3 pin while the system is off. Then return to 1-2 pin position. Avoid clearing the CMOS while the system is on; it will damage the motherboard.

AT/ATX Jumper: JAT1

This jumper allows users to select between AT and ATX power.



ME Jumper: JME1

This jumper is used to enable/disable the Intel ME function.



eDP Power Jumper: JEDP_VDD1

This jumper specifies the operation voltage of the eDP connector.



JCOM1~JCOM2 Power Jumper: JCOMP1, JCOMP2

These jumpers specify the operation voltage of the JCOM1~JCOM2 serial ports.

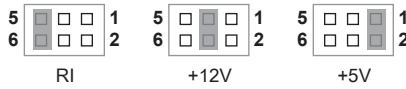

JCOM3~JCOM6 Power Jumper: JCOMP3 ~ JCOMP6

These jumpers specify the operation voltage of the JCOM3~JCOM6 serial ports.

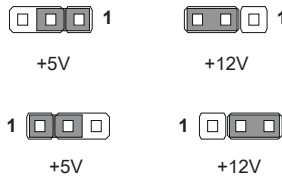

LVDS Power Jumper: JVDD1, JVDD2

Use this jumper to specify the operation voltage of the LVDS interface flat panel.



LVDS Inverter Power Jumper: JINVDD1, JINVDD2

Use this jumper to specify the operation voltage of the interver interface flat panel.

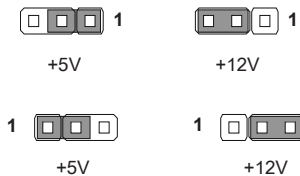

Slot

PCIe (Peripheral Component Interconnect Express) Slot

The PCI Express slot supports PCIe interface expansion cards (signal shared with M.2 Key M, auto switch by switch IC and PCIe x4 as top priority).

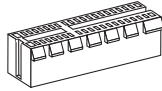

PCIe x4 slot

M2_M1: M.2 Slot (Key M, 2280) for SSD

Please install the M.2 solid-state drive (SSD) into the M.2 slot as shown below.

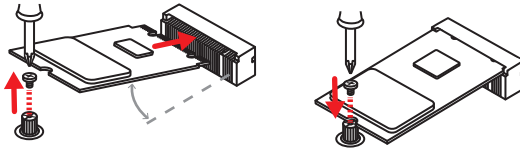

Important

Intel® RST only supports PCIe M.2 SSD with UEFI ROM and does not support Legacy ROM.

M2_E1: M.2 Slot (Key E, 2230) for WiFi/BT

Please install the Wi-Fi/ Bluetooth card into the M.2 slot as shown below.

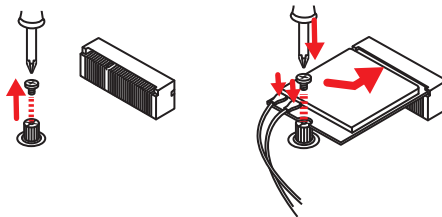

Mini-PCle (Peripheral Component Interconnect Express) Slot

The Mini-PCle slot is provided for WiFi modules, Bluetooth modules, TV tuner cards and other Mini-PCle cards.

- **MPCIE/MSATA1** slot supports **Mini-PCle** and **mSATA** cards.
- **MINI_PCIE1** slot supports **Mini-PCle** cards.

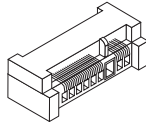

Nano SIM Holder

This holder is provided for 3G, 4G, LTE, WiFi, BT, CANBus Nano SIM cards.

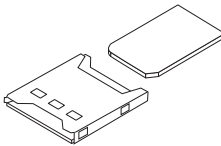

Important

When adding or removing expansion cards, make sure that you unplug the power supply first. Meanwhile, read the documentation for the expansion card to configure any necessary hardware or software settings for the expansion card, such as jumpers, switches or BIOS configuration.



3 BIOS Setup

This chapter provides information on the BIOS Setup program and allows users to configure the system for optimal use.

Users may need to run the Setup program when:

- An error message appears on the screen at system startup and requests users to run SETUP.
- Users want to change the default settings for customized features.

Important

- *Please note that BIOS update assumes technician-level experience.*
- *As the system BIOS is under continuous update for better system performance, the illustrations in this chapter should be held for reference only.*

Entering Setup

Power on the computer and the system will start POST (Power On Self Test) process. When the message below appears on the screen, press or <F2> key to enter Setup.

Press or <F2> to enter SETUP

If the message disappears before you respond and you still wish to enter Setup, restart the system by turning it OFF and On or pressing the RESET button. You may also restart the system by simultaneously pressing <Ctrl>, <Alt>, and <Delete> keys.

Important

The items under each BIOS category described in this chapter are under continuous update for better system performance. Therefore, the description may be slightly different from the latest BIOS and should be held for reference only.

Control Keys

← →	Select Screen
↑ ↓	Select Item
Enter	Select
+ -	Change Option
F1	General Help
F7	Previous Values
F9	Optimized Defaults
F10	Save & Reset
Esc	Exit

Getting Help

After entering the Setup menu, the first menu you will see is the Main Menu.

Main Menu

The main menu lists the setup functions you can make changes to. You can use the arrow keys (↑ ↓) to select the item. The on-line description of the highlighted setup function is displayed at the bottom of the screen.

Sub-Menu

If you find a right pointer symbol appears to the left of certain fields that means a sub-menu can be launched from this field. A sub-menu contains additional options for a field parameter. You can use arrow keys (↑ ↓) to highlight the field and press <Enter> to call up the sub-menu. Then you can use the control keys to enter values and move from field to field within a sub-menu. If you want to return to the main menu, just press the <Esc >.

General Help <F1>

The BIOS setup program provides a General Help screen. You can call up this screen from any menu by simply pressing <F1>. The Help screen lists the appropriate keys to use and the possible selections for the highlighted item. Press <Esc> to exit the Help screen.

The Menu Bar

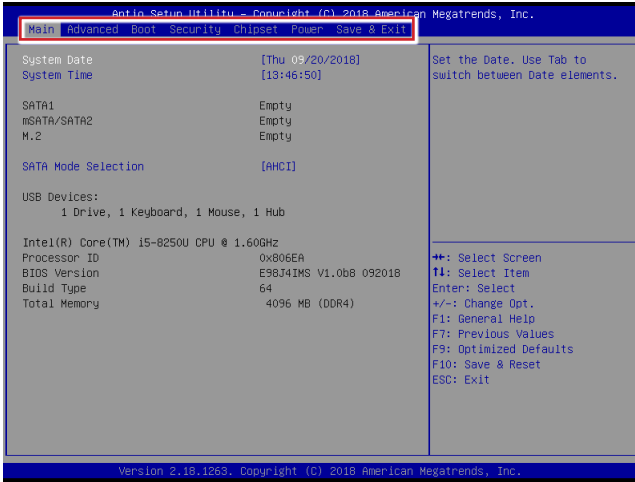

► Main

Use this menu for basic system configurations, such as time, date, etc.

► Advanced

Use this menu to set up the items of special enhanced features.

► Boot

Use this menu to specify the priority of boot devices.

► Security

Use this menu to set supervisor and user passwords.

► Chipset

This menu controls the advanced features of the onboard chipsets.

► Power

Use this menu to specify your settings for power management.

► Save & Exit

This menu allows you to load the BIOS default values or factory default settings into the BIOS and exit the BIOS setup utility with or without changes.

Main

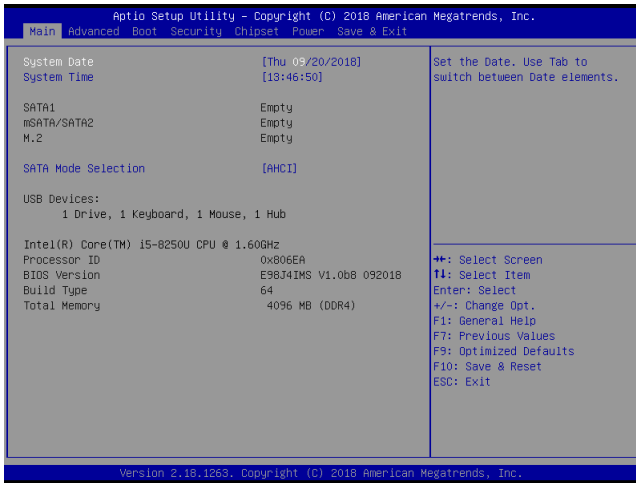

► System Date

This setting allows you to set the system date. The date format is <Day>, <Month> <Date> <Year>.

► System Time

This setting allows you to set the system time. The time format is <Hour> <Minute> <Second>.

► SATA Mode Selection

This setting specifies the SATA controller mode.

Advanced

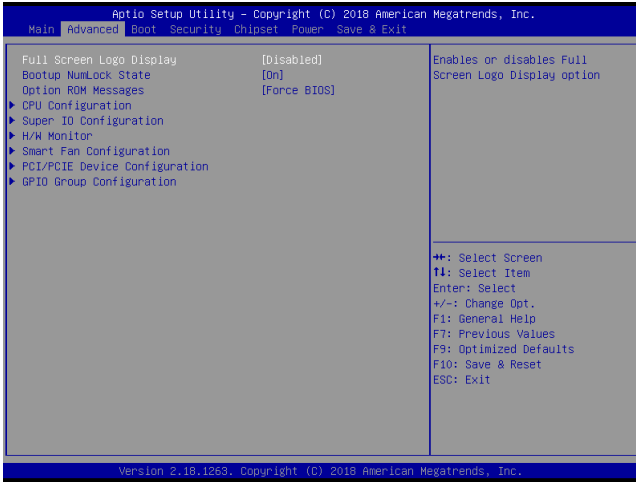

► Full Screen Logo Display

This BIOS feature determines if the BIOS should hide the normal POST messages with the motherboard or system manufacturer's full-screen logo.

When it is enabled, the BIOS will display the full-screen logo during the boot-up sequence, hiding normal POST messages.

When it is disabled, the BIOS will display the normal POST messages, instead of the full-screen logo.

Please note that enabling this BIOS feature often adds 2-3 seconds of delay to the booting sequence. This delay ensures that the logo is displayed for a sufficient amount of time. Therefore, it is recommended that you disable this BIOS feature for a faster boot-up time.

► Bootup NumLock State

This setting is to set the Num Lock status when the system is powered on. Setting to [On] will turn on the Num Lock key when the system is powered on. Setting to [Off] will allow users to use the arrow keys on the numeric keypad.

► Option ROM Messages

This item is used to determine the display mode when an optional ROM is initialized during POST. When set to [Force BIOS], the display mode used by AMI BIOS is used. Select [Keep Current] if you want to use the display mode of optional ROM.

► CPU Configuration

Advanced	
CPU Configuration	
Intel(R) Core(TM) i5-8250U CPU @ 1.60GHz	
Processor ID	0x806EA
Processor Speed	1800 MHz
L2 Cache	256 KB x 4
L3 Cache	6 MB
Intel Virtualization Technology	[Enabled]
Active Processor Cores	[All]
Execute Disable Bit	[Enabled]
Hyper-Threading	[Enabled]
Intel(R) SpeedStep(tm)	[Enabled]
C states	[Enabled]

► Intel Virtualization Technology

Virtualization enhanced by Intel Virtualization Technology will allow a platform to run multiple operating systems and applications in independent partitions. With virtualization, one computer system can function as multiple “Virtual” systems.

► Active Processor Cores

This setting specifies the number of active processor cores.

► Execute Disable Bit

Intel’s Execute Disable Bit functionality can prevent certain classes of malicious “buffer overflow” attacks when combined with a supporting operating system. This functionality allows the processor to classify areas in memory by where application code can execute and where it cannot. When a malicious worm attempts to insert code in the buffer, the processor disables code execution, preventing damage or worm propagation.

► Hyper-Threading

The processor uses Hyper-Threading technology to increase transaction rates and reduces end-user response times. The technology treats the two cores inside the processor as two logical processors that can execute instructions simultaneously. In this way, the system performance is highly improved. If you disable the function, the processor will use only one core to execute the instructions. Please disable this item if your operating system doesn’t support HT Function, or unreliability and instability may occur.

► Intel(R) SpeedStep(tm)

EIST (Enhanced Intel SpeedStep Technology) allows the system to dynamically adjust processor voltage and core frequency, which can result in decreased average power consumption and decreased average heat production. When disabled, the processor will return the actual maximum CPUID input value of the processor when queried.

► C States

This setting controls the C-State (CPU Power state). C-State performance indicates the ability to run the processor in lower power states when the PC is idle. This setting enables/disables the C-State Configuration for power saving purposes.

► Super IO Configuration



► Serial Port 1/ 2/ 3/ 4

This setting enables/disables the specified serial port.

► Change Settings

This setting is used to change the address & IRQ settings of the specified serial port.

► Mode Select

Select an operation mode for the specified serial port.

► Watch Dog Timer

You can enable the system watch-dog timer, a hardware timer that generates a reset when the software that it monitors does not respond as expected each time the watch dog polls it.

► FIFO Mode

This setting controls the FIFO data transfer mode.

► Shared IRQ Mode

This setting provides the system with the ability to share interrupts among its serial ports.

► H/W Monitor

These items display the current status of all monitored hardware devices/ components such as voltages, temperatures and all fans' speeds.

Advanced	
PC Health Status	
CPU temperature	: +32 C
System temperature	: +32 C
CPUFAN1	: 5617 RPM
SYSFAN1	: N/A
VCC_CORE	: +0.768 V
VCC3	: +3.279 V
VCC5	: +5.045 V
+12V	: +12.920 V
VCC3V	: +3.280 V
VSB3V	: +3.264 V
VSB5V	: +4.968 V
VBAT	: +3.168 V

► Smart Fan Configuration

Advanced	
Configuration Smart FAN	
CPUFAN1	[Disabled]
SYSFAN1	[Disabled]

► CPUFAN1, SYSFAN1

This setting enables/disables the Smart Fan function. Smart Fan is an excellent feature which will adjust the CPU/system fan speed automatically depending on the current CPU/system temperature, avoiding the overheating to damage your system.

► **PCI/PCIE Device Configuration**



► **Legacy USB Support**

Set to [Enabled] if you need to use any USB 1.1/2.0 device in the operating system that does not support or have any USB 1.1/2.0 driver installed, such as DOS and SCO Unix.

► **Audio Controller**

This setting enables/disables the onboard audio controller.

► **Launch OnBoard LAN OpROM**

These settings enable/disable the initialization of the onboard/onchip LAN Boot ROM during bootup. Selecting [Disabled] will speed up the boot process.

▶ GPIO Group Configuration

Advanced	
GPIO Group Configuration	
GPIO0	[Low]
GPIO1	[Low]
GPIO2	[Low]
GPIO3	[Low]

▶ GPIO0 ~ GPIO3

These settings control the operation mode of the specified GPIO.

Boot

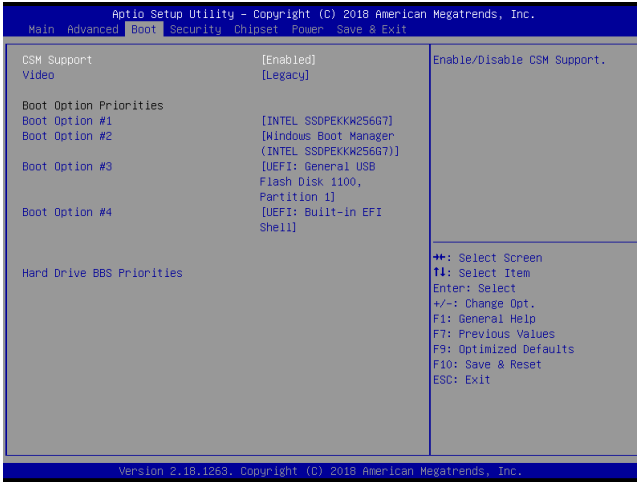

► **CSM Support**

This setting enables/disables the support for Compatibility Support Module, a part of the Intel Platform Innovation Framework for EFI providing the capability to support legacy BIOS interfaces.

► **Video**

This setting selects the video mode.

► **Boot Option Priorities**

This setting allows users to set the sequence of boot devices where BIOS attempts to load the disk operating system.

► **Hard Drive BBS Priorities**

This setting allows users to set the priority of the specified devices. First press <Enter> to enter the sub-menu. Then you may use the arrow keys (↑↓) to select the desired device, then press <+>, <-> or <PageUp>, <PageDown> key to move it up/down in the priority list.

Security

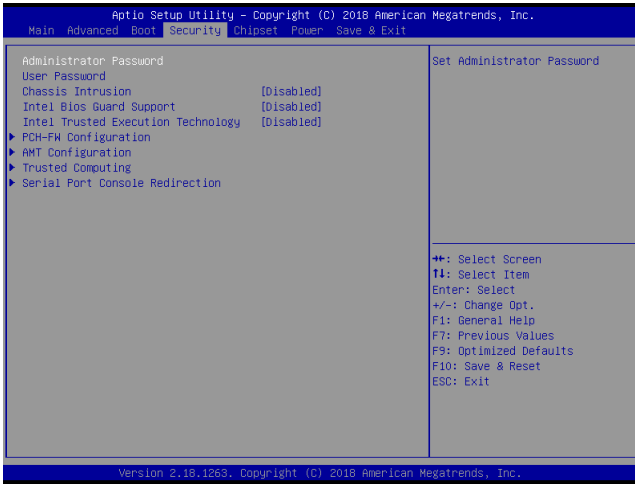

► Administrator Password

Administrator Password controls access to the BIOS Setup utility.

► User Password

User Password controls access to the system at boot and to the BIOS Setup utility.

► Chassis Intrusion

The field enables or disables the feature of recording the chassis intrusion status and issuing a warning message if the chassis is once opened.

► Intel BIOS Guard Support

Intel BIOS Guard Support ensures that updates to system BIOS flash are secure.

► Intel Trusted Execution Technology

Intel Trusted Execution Technology provides highly scalable platform security in physical and virtual infrastructures.

► PCH-FW Configuration

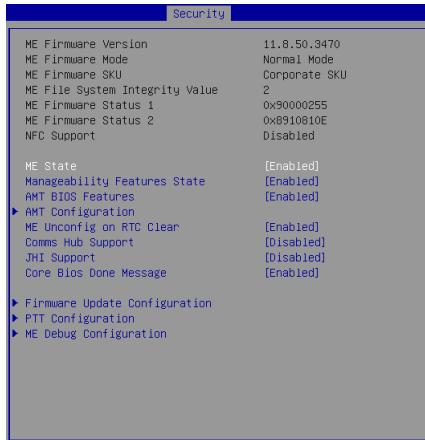

► **ME Firmware Version, ME Firmware Mode, ME Firmware SKU, ME File System Integrity Value, ME Firmware Status 1, ME Firmware Status 2, NFC Support**

These settings show the firmware information of the Intel ME (Management Engine).

► **ME State**

This setting enables/disables the ME status.

► **Manageability Features State**

This setting enables/disables the Manageability Features State.

► **ME Unconfig on RTC Clear**

This setting enables/disables ME firmware unconfigure on RTC clear.

► **Comms Hub Support**

This setting enables/disables Communications Hub Support.

► **JHI Support**

This setting enables/disables support for Intel Dynamic Application Loader Host Interface (JHI).

► **Core BIOS Done Message**

This setting enables/disables Core BIOS Done Message sent to ME.

► Firmware Update Configuration



► ME FW Image Re-Flash

This setting enables/disables the ME FW image reflash.

► PTT Configuration

Intel Platform Trust Technology (PTT) is a platform functionality for credential storage and key management used by Microsoft Windows.

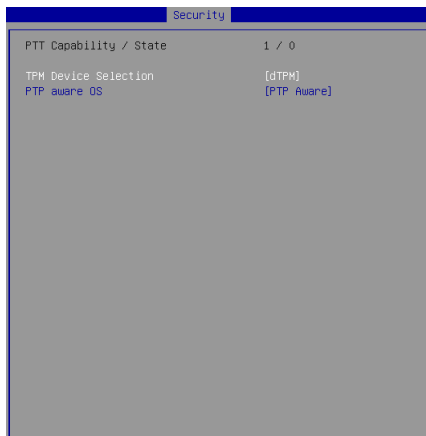

► ME Debug Configuration

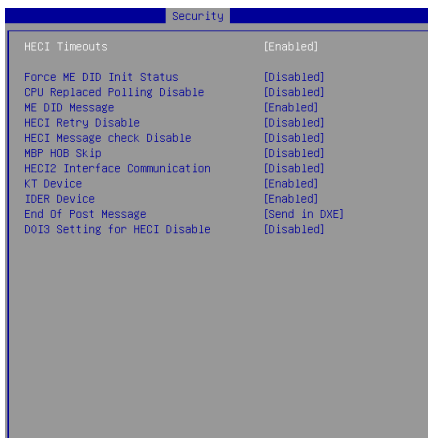

► AMT Configuration

Intel Active Management Technology (AMT) is hardware-based technology for remotely managing and securing PCs out-of-band.



► Trusted Computing

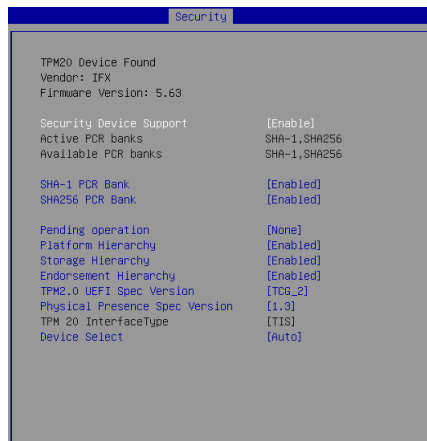

► Security Device Support

This setting enables/disables BIOS support for security device. When set to [Disable], the OS will not show security device. TCG EFI protocol and INT1A interface will not be available.

► SHA-1 PCR Bank, SHA256 PCR Bank

These settings enable/disable the SHA-1 PCR Bank and SHA256 PCR Bank.

► Pending Operation

When **Security Device Support** is set to [Enable], **Pending Operation** will appear. Set this item to [TPM Clear] to clear all data secured by TPM or [None] to discard the selection. It is advised that users should routinely back up their TPM secured data.

► Platform Hierarchy, Storage Hierarchy, Endorsement Hierarchy

These settings enable/disable the Platform Hierarchy, Storage Hierarchy and Endorsement Hierarchy.

► TPM2.0 UEFI Spec Version, Physical Presence Spec Version

This settings show the TPM2.0 UEFI Spec Version and Physical Presence Spec Version.

► TPM2.0 Interface Type

This setting shows the TPM2.0 Interface Type.

► Device Select

This setting allows users to select the TPM device.

► **Serial Port Console Redirection**

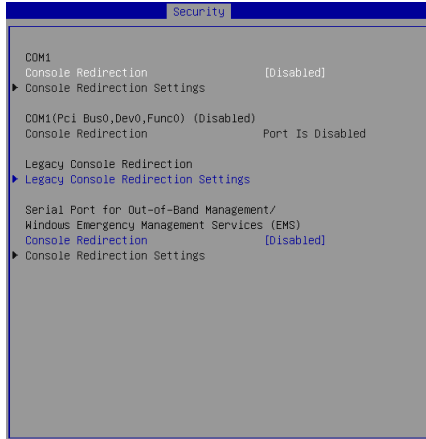

COM1

► **Console Redirection**

Console Redirection operates in host systems that do not have a monitor and keyboard attached. This setting enables/disables the operation of console redirection. When set to [Enabled], BIOS redirects and sends all contents that should be displayed on the screen to the serial COM port for display on the terminal screen. Besides, all data received from the serial port is interpreted as keystrokes from a local keyboard.

► **Console Redirection Settings**

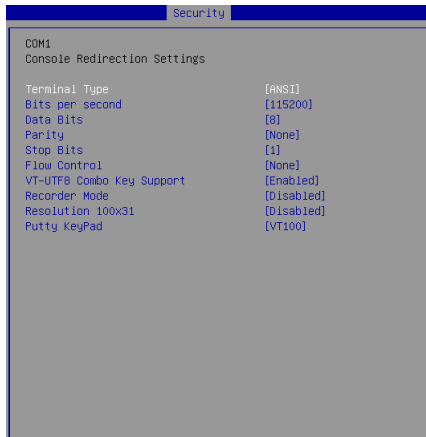

► **Terminal Type**

To operate the system's console redirection, you need a terminal supporting ANSI terminal protocol and a RS-232 null modem cable connected between

the host system and terminal(s). This setting specifies the type of terminal device for console redirection.

► **Bits per second, Data Bits, Parity, Stop Bits**

This setting specifies the transfer rate (bits per second, data bits, parity, stop bits) of Console Redirection.

► **Flow Control**

Flow control is the process of managing the rate of data transmission between two nodes. It's the process of adjusting the flow of data from one device to another to ensure that the receiving device can handle all of the incoming data. This is particularly important where the sending device is capable of sending data much faster than the receiving device can receive it.

► **VT-UTF8 Combo Key Support**

This setting enables/disables the VT-UTF8 combination key support for ANSI/VT100 terminals.

► **Recorder Mode, Resolution 100x31**

These settings enable/disable the recorder mode and the resolution 100x31.

► **Putty Keypad**

PuTTY is a terminal emulator for Windows. This setting controls the numeric keypad for use in PuTTY.

Legacy Console Redirection

► **Legacy Console Redirection Settings**

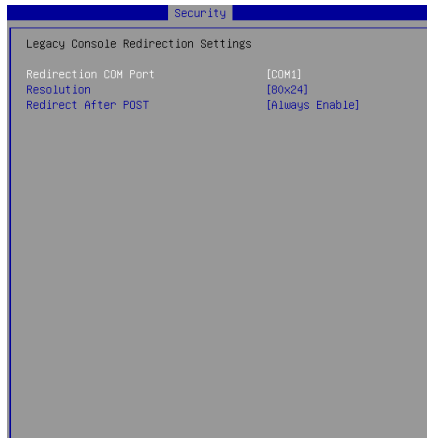

► **Redirection COM Port**

This setting specifies the COM port for redirection.

► **Resolution**

This setting specifies the redirection resolution of legacy OS.

► **Redirect After POST**

This setting determines whether or not to keep terminals' console redirection running after the POST has booted.

Serial Port for Out-of-Band Management/ Windows Emergency Management Services (EMS)

► **Console Redirection**

Console Redirection operates in host systems that do not have a monitor and keyboard attached. This setting enables/disables the operation of console redirection. When set to [Enabled], BIOS redirects and sends all contents that should be displayed on the screen to the serial COM port for display on the terminal screen. Besides, all data received from the serial port is interpreted as keystrokes from a local keyboard.

► **Console Redirection Settings**



► **Out-of-Band Mgmt Port**

This setting specifies the Out-of-Band Management Port.

► **Terminal Type**

To operate the system's console redirection, you need a terminal supporting ANSI terminal protocol and a RS-232 null modem cable connected between the host system and terminal(s). This setting specifies the type of terminal device for console redirection.

► **Bits per second, Data Bits, Parity, Stop Bits**

This setting specifies the transfer rate (bits per second, data bits, parity, stop bits) of Console Redirection.

► **Flow Control**

Flow control is the process of managing the rate of data transmission between two nodes. It's the process of adjusting the flow of data from one device to another to ensure that the receiving device can handle all of the incoming data. This is particularly important where the sending device is capable of sending data much faster than the receiving device can receive it.

Chipset

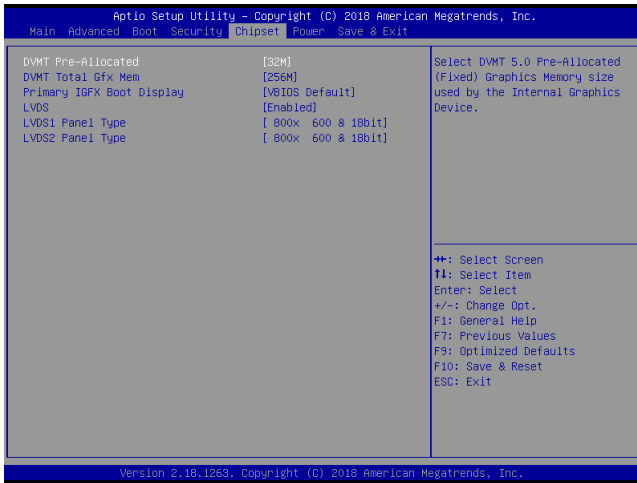

► DVMT Pre-Allocated

This setting selects DVMT 5.0 Pre-Allocated (Fixed) Graphics Memory size used by the Internal Graphics Device.

► DVMT Total Gfx Mem

This setting specifies the memory size for DVMT.

► Primary IGFX Boot Display

Use the field to select the primary IGFX boot display of the system.

► LVDS

This setting enables/disables the LVDS interface.

► LVDS1, LVDS2 Panel Type

This setting allows you to set the resolution of the LVDS display.

Power

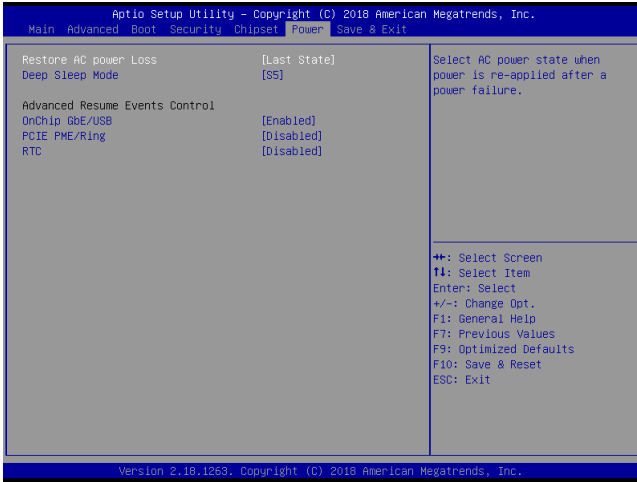

► Restore AC Power Loss

This setting specifies whether your system will reboot after a power failure or interrupt occurs. Available settings are:

[Power Off]	Leaves the computer in the power off state.
[Power On]	Leaves the computer in the power on state.
[Last State]	Restores the system to the previous status before power failure or interrupt occurred.

► Deep Sleep Mode

The setting enables/disables the Deep S5 power saving mode. S5 is almost the same as G3 Mechanical Off, except that the PSU still supplies power, at a minimum, to the power button to allow return to S0. A full reboot is required. No previous content is retained. Other components may remain powered so the computer can “wake” on input from the keyboard, clock, modem, LAN, or USB device.

**** Advanced Resume Events Control ******▶ OnChip GbE/USB**

This field specifies whether the system will be awakened from power saving modes when activity or input signal of onchip LAN or USB devices is detected.

▶ PCIE PME/Ring

This field specifies whether the system will be awakened from power saving modes when activity or input signal of onboard PCIE PME/Ring is detected.

▶ RTC

When [Enabled], you can set the date and time at which the RTC (real-time clock) alarm awakens the system from suspend mode.

Save & Exit

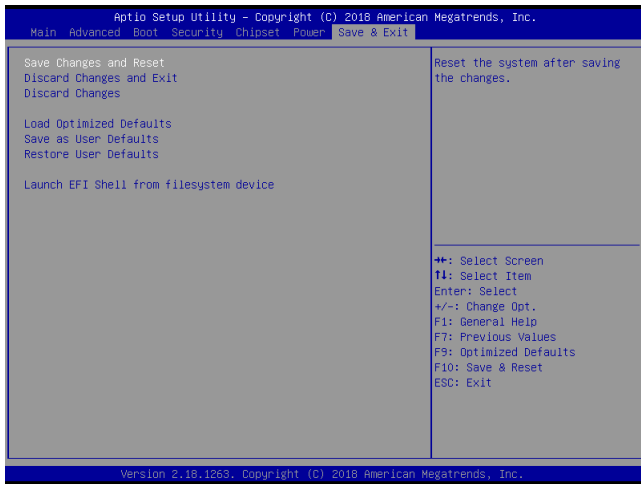

► Save Changes and Reset

Save changes to CMOS and reset the system.

► Discard Changes and Exit

Abandon all changes and exit the Setup Utility.

► Discard Changes

Abandon all changes.

► Load Optimized Defaults

Use this menu to load the default values set by the motherboard manufacturer specifically for optimal performance of the motherboard.

► Save as User Defaults

Save changes as the user's default profile.

► Restore User Defaults

Restore the user's default profile.

► Launch EFI Shell from filesystem device

This setting helps to launch the EFI Shell application from one of the available file system devices.

Appendix

GPIO WDT BKL Programming



This appendix provides WDT (Watch Dog Timer), GPIO (General Purpose Input/ Output) and LVDS Backlight programming guide.

CONTENT

Abstract.....	A-3
General Purposed IO.....	A-4
Watchdog Timer.....	A-5
LVDS Backlight Brightness Control	A-6
SMBus Access.....	A-7

Abstract

In this document, code examples based on C programming language are provided for customer interest. **Inportb**, **Outportb**, **Inportl** and **Outportl** are basic functions used for access IO ports and defined as following.

Inportb: Read a single 8-bit I/O port.

Outportb: Write a single byte to an 8-bit port.

Inportl: Reads a single 32-bit I/O port.

Outportl: Write a single long to a 32-bit port.

General Purposed IO

1. General Purposed IO – GPIO/DIO

The GPIO port configuration addresses are listed in the following table:

Name	IO Port	IO address	Name	IO Port	IO address
N_GPIO0	0x22	Bit 4	N_GPO0	0x21	Bit 0
N_GPIO1	0x22	Bit 5	N_GPO1	0x21	Bit 1
N_GPIO2	0x22	Bit 6	N_GPO2	0x21	Bit 2
N_GPIO3	0x22	Bit 7	N_GPO3	0x21	Bit 3

Note: GPIO should be accessed through controller device **0x9C** on SMBus. The associated access method in examples (**SMBus_ReadByte**, **SMBus_WriteByte**) are provided in part 4.

1.1 Set output value of GPO

1. Read the value from GPO port.
2. Set the value of GPO address.
3. Write the value back to GPO port.

Example: Set **N_GPO0** output “high”

```
val =SMBus_ReadByte (0x9C, 0x21); // Read value from N_GPO0 port through SMBus.
val = val | (1<<0); // Set N_GPO0 address (bit 0) to 1 (output “high”).
SMBus_WriteByte (0x9C, 0x21, val); // Write back to N_GPO0 port through SMBus.
```

Example: Set **N_GPO1** output “low”

```
val = SMBus_ReadByte (0x9C, 0x21); // Read value from N_GPO1 port through SMBus..
val = val & (~(1<<1)); // Set N_GPO1 address (bit 1) to 0 (output “low”).
SMBus_WriteByte (0x9C, 0x21, val); // Write back to N_GPO1 port through SMBus.
```

1.2 Read input value from GPI:

1. Read the value from GPI port.
2. Get the value of GPI address.

Example: Get **N_GPI2** input value.

```
val = SMBus_ReadByte (0x9C, 0x22); // Read value from N_GPI2 port through SMBus.
val = val & (1<<6); // Read N_GPI2 address (bit 6).
if (val) printf (“Input of N_GPI2 is High”);
else printf (“Input of N_GPI2 is Low”);
```

Example: Get **N_GPI6** input value.

```
val = SMBus_ReadByte (0x9C, 0x22); // Read value from N_GPI3 port through SMBus.
val = val & (1<<7); // Read N_GPI6 address (bit 7).
if (val) printf (“Input of N_GPI3 is High”);
else printf (“Input of N_GPI3 is Low”);
```

Watchdog Timer

2. Watchdog Timer – WDT

The base address (WDT_BASE) of WDT configuration registers is [0xA10](#).

2.1 Set WDT Time Unit

```
val = Inportb (WDT_BASE + 0x05); // Read current WDT setting
val = val | 0x08; // minute mode. val = val & 0xF7 if second mode
Outportb (WDT_BASE + 0x05, val); // Write back WDT setting
```

2.2 Set WDT Time

```
Outportb (WDT_BASE + 0x06, Time); // Write WDT time, value 1 to 255.
```

2.3 Enable WDT

```
val = Inportb (WDT_BASE + 0x0A); // Read current WDT_PME setting
val = val | 0x01; // Enable WDT OUT: WDMOUT_EN (bit 0) set to 1.
Outportb (WDT_BASE + 0x0A, val); // Write back WDT setting.
val = Inportb (WDT_BASE + 0x05); // Read current WDT setting
val = val | 0x20; // Enable WDT by set WD_EN (bit 5) to 1.
Outportb (WDT_BASE + 0x05, val); // Write back WDT setting.
```

2.4 Disable WDT

```
val = Inportb (WDT_BASE + 0x05); // Read current WDT setting
val = val & 0xDF; // Disable WDT by set WD_EN (bit 5) to 0.
Outportb (WDT_BASE + 0x05, val); // Write back WDT setting.
```

2.5 Check WDT Reset Flag

If the system has been reset by WDT function, this flag will set to 1.

```
val = Inportb (WDT_BASE + 0x05); // Read current WDT setting.
val = val & 0x40; // Check WDMOUT_STS (bit 6).
if (val) printf ("timeout event occurred");
else printf ("timeout event not occurred");
```

2.6 Clear WDT Reset Flag

```
val = Inportb (WDT_BASE + 0x05); // Read current WDT setting
val = val | 0x40; // Set 1 to WDMOUT_STS (bit 6);
Outportb (WDT_BASE + 0x05, val); // Write back WDT setting
```

LVDS Backlight Brightness Control

3. LVDS Backlight Brightness Control

The LVDS controller support 17 level of backlight brightness value from 0 (30%) to 16 (100%) and it is accessible through SMBus. The associated access method (**SMBus_ReadByte**, **SMBus_WriteByte**) are provided in part 4.

3.1 Set the Level of LVDS Backlight

1. Write **0xED** into address **0x7F** on SMBus device **0x42**.
2. Write desired backlight level from 0x0 (30%) to 0x10 (100%) into address **0x6E** on SMBus device **0x42**.

Example: Set LVDS backlight level to 0x10 (100%)

```
SMBus_WriteByte (0x42, 0x7F, 0xED);
```

```
SMBus_WriteByte (0x42, 0x6E, 0x10); // Set brightness to 100%
```

3.2 Read the Level of LVDS Backlight

1. Write **0xED** into address **0x7F** on SMBus device **0x42**.
2. Read current backlight level from address **0x6E** on SMBus device **0x42**.

Example: Get LVDS backlight level

```
SMBus_WriteByte (0x42, 0x7F, 0xED);
```

```
BKL_Value = SMBus_ReadByte (0x42, 0x6E);
```

SMBus Access

4. SMBus Access

The base address of SMBus must be known before access. The relevant bus and device information are as following.

```
#define IO_SC          0xCF8
#define IO_DA          0xCFC
#define PCIBASEADDRESS 0x80000000
#define PCI_BUS_NUM    0
#define PCI_DEV_NUM    31
#define PCI_FUN_NUM    4
```

4.1 Get SMBus Base Address

```
int SMBUS_BASE;
int DATA_ADDR = PCIBASEADDRESS + (PCI_BUS_NUM<<16) +
                (PCI_DEV_NUM<<11) +
                (PCI_FUN_NUM<<8);

Outportl (DATA_ADDR + 0x20, IO_SC);
SMBUS_BASE = Inportl (IO_DA) & 0xfffffff0;
```

4.2 SMBus_ReadByte (char DEVID, char offset)

Read the value of OFFSET from SMBus device DEVID.

```
Outportb (LOWORD (SMBUS_BASE), 0xFE);
Outportb (LOWORD (SMBUS_BASE) + 0x04, DEVID + 1); //out Base + 04, (DEVID + 1)
Outportb (LOWORD (SMBUS_BASE) + 0x03, OFFSET); //out Base + 03, OFFSET
Outportb (LOWORD (SMBUS_BASE) + 0x02, 0x48); //out Base + 02, 48H
mdelay (20); //delay 20ms to let data ready
while ((Inportl (SMBUS_BASE) & 0x01) != 0); //wait SMBus ready
SMB_DATA = Inportb (LOWORD (SMBUS_BASE) + 0x05); //input Base + 05
```

4.3 SMBus_WriteByte (char DEVID, char offset, char DATA)

Write DATA to OFFSET on SMBus device DEVID.

```
Outportb (LOWORD (SMBUS_BASE), 0xFE);
Outportb (LOWORD (SMBUS_BASE) + 0x04, DEVID); //out Base + 04, (DEVID)
Outportb (LOWORD (SMBUS_BASE) + 0x03, OFFSET); //out Base + 03, OFFSET
Outportb (LOWORD (SMBUS_BASE) + 0x05, DATA); //out Base + 05, DATA
Outportb (LOWORD (SMBUS_BASE) + 0x02, 0x48); //out Base + 02, 48H
mdelay (20); //wait 20ms
```