

MS-9B11-S1

MS-9B11-S2

Industrial Data Machine



Copyright and Trademarks Notice

Copyright © Micro-Star Int'l Co., Ltd. All rights reserved. The MSI logo used is a registered trademark of Micro-Star Int'l Co., Ltd. All other marks and names mentioned may be trademarks of their respective owners. No warranty as to accuracy or completeness is expressed or implied. MSI reserves the right to make changes to this document without prior notice.

Revision History

Revision	Date
V1.1	2019/12

Technical Support

If a problem arises with your product and no solution can be obtained from the user's manual, please contact your place of purchase or local distributor. Alternatively, please visit <https://www.msi.com/support/> for further guidance.

Safety Instructions

- Always read the safety instructions carefully.
- Keep this User's Manual for future reference.
- Keep this equipment away from humidity.
- Lay this equipment on a reliable flat surface before setting it up.
- The openings on the enclosure are for air convection hence protects the equipment from overheating. **DO NOT COVER THE OPENINGS.**
- Make sure the voltage of the power source and adjust properly 110/220V before connecting the equipment to the power inlet.
- Place the power cord such a way that people can not step on it. Do not place anything over the power cord.
- Always Unplug the Power Cord before inserting any add-on card or module.
- All cautions and warnings on the equipment should be noted.
- Never pour any liquid into the opening that could damage or cause electrical shock.
- If any of the following situations arises, get the equipment checked by service personnel:
 - The power cord or plug is damaged.
 - Liquid has penetrated into the equipment.
 - The equipment has been exposed to moisture.
 - The equipment does not work well or you can not get it work according to User's Manual.
 - The equipment has dropped and damaged.
 - The equipment has obvious sign of breakage.
- **DO NOT LEAVE THIS EQUIPMENT IN AN ENVIRONMENT UNCONDITIONED, STORAGE TEMPERATURE ABOVE 60°C (140°F), IT MAY DAMAGE THE EQUIPMENT.**
- When re-plug the DC-in cable, the interval time should be longer than 5 seconds.

警告使用者:

此為甲類資訊技術設備，於居住環境中使用時，可能會造成射頻擾動，在此種情況下，使用者會被要求採取某些適當的對策。

Chemical Substances Information

In compliance with chemical substances regulations, such as the EU REACH Regulation (Regulation EC No. 1907/2006 of the European Parliament and the Council), MSI provides the information of chemical substances in products at:

https://www.msi.com/html/popup/csr/evmtrprt_pcm.html

Battery Information



European Union:

Batteries, battery packs, and accumulators should not be disposed of as unsorted household waste. Please use the public collection system to return, recycle, or treat them in compliance with the local regulations.



廢電池請回收

Taiwan:

For better environmental protection, waste batteries should be collected separately for recycling or special disposal.



California, USA:

The button cell battery may contain perchlorate material and requires special handling when recycled or disposed of in California.

For further information please visit:

<https://www.dtsc.ca.gov/hazardouswaste/perchlorate/>

Danger of explosion if battery is incorrectly replaced. Replace only with the same or equivalent type recommended by the manufacturer.

CE Conformity

Hereby, Micro-Star International CO., LTD declares that this device is in compliance with the essential safety requirements and other relevant provisions set out in the European Directive.



FCC-A Radio Frequency Interference Statement



This equipment has been tested and found to comply with the limits for a Class A digital device, pursuant to Part 15 of the FCC Rules. These limits are designed to provide reasonable protection against harmful interference when the equipment is operated in a commercial environment. This equipment generates, uses and can radiate radio frequency energy and, if not installed and used in accordance with the instruction manual, may cause harmful interference to radio communications. Operation of this equipment in a residential area is likely to cause harmful interference, in which case the user will be required to correct the interference at his own expense.

Notice 1

The changes or modifications not expressly approved by the party responsible for compliance could void the user's authority to operate the equipment.

Notice 2

Shielded interface cables and AC power cord, if any, must be used in order to comply with the emission limits.

This device complies with Part 15 of the FCC Rules. Operation is subject to the following two conditions:

- 1) this device may not cause harmful interference, and
- 2) this device must accept any interference received, including interference that may cause undesired operation.

WEEE Statement

Under the European Union ("EU") Directive on Waste Electrical and Electronic Equipment, Directive 2002/96/EC, which takes effect on August 13, 2005, products of "electrical and electronic equipment" cannot be discarded as municipal waste anymore and manufacturers of covered electronic equipment will be obligated to take back such products at the end of their useful life.



CONTENTS

Copyright and Trademarks Notice.....	ii
Revision History	ii
Technical Support.....	ii
Safety Instructions.....	iii
Chemical Substances Information	iv
Battery Information	iv
CE Conformity.....	v
FCC-A Radio Frequency Interference Statement	v
WEEE Statement	v
1 Overview.....	1-1
System Overview	1-2
System Specifications	1-8
Motherboard Jumpers.....	1-10
Mechanical Overview (MS-9B11-S1)	1-13
Mechanical Overview (MS-9B11-S2)	1-16
2 Getting Started.....	2-1
Top Cover (MS-9B11-S1).....	2-2
Top Cover (MS-9B11-S2).....	2-3
CPU.....	2-4
Installing Heatsink (MS-9B11-S1)	2-7
Installing Cooler (MS-9B11-S2).....	2-9
Memory	2-11
Hard Disk Drive (Internal).....	2-12
Hard Disk Drive (External)	2-16
PCIe Expansion Card.....	2-18
Mini PCIe WiFi Card (Optional).....	2-19
M.2 Slot (Key M, 2280 & 2242).....	2-22
Mounting Brackets (Desktop).....	2-23
Mounting Brackets (Vertical)	2-24
Power (Optional)	2-25
Extension Power Switch (Optional).....	2-26
DIN Rail (Optional).....	2-27

3 BIOS Setup	3-1
Entering Setup	3-2
The Menu Bar	3-4
Main	3-5
Advanced	3-6
Boot.....	3-12
Security	3-13
Chipset	3-21
Power	3-22
Save & Exit.....	3-24
Appendix GPIO WDT BKL Programming	A-1
Abstract.....	A-3
General Purposed IO	A-4
Watchdog Timer	A-5
LVDS Backlight Brightness Control	A-6
SMBus Access	A-7

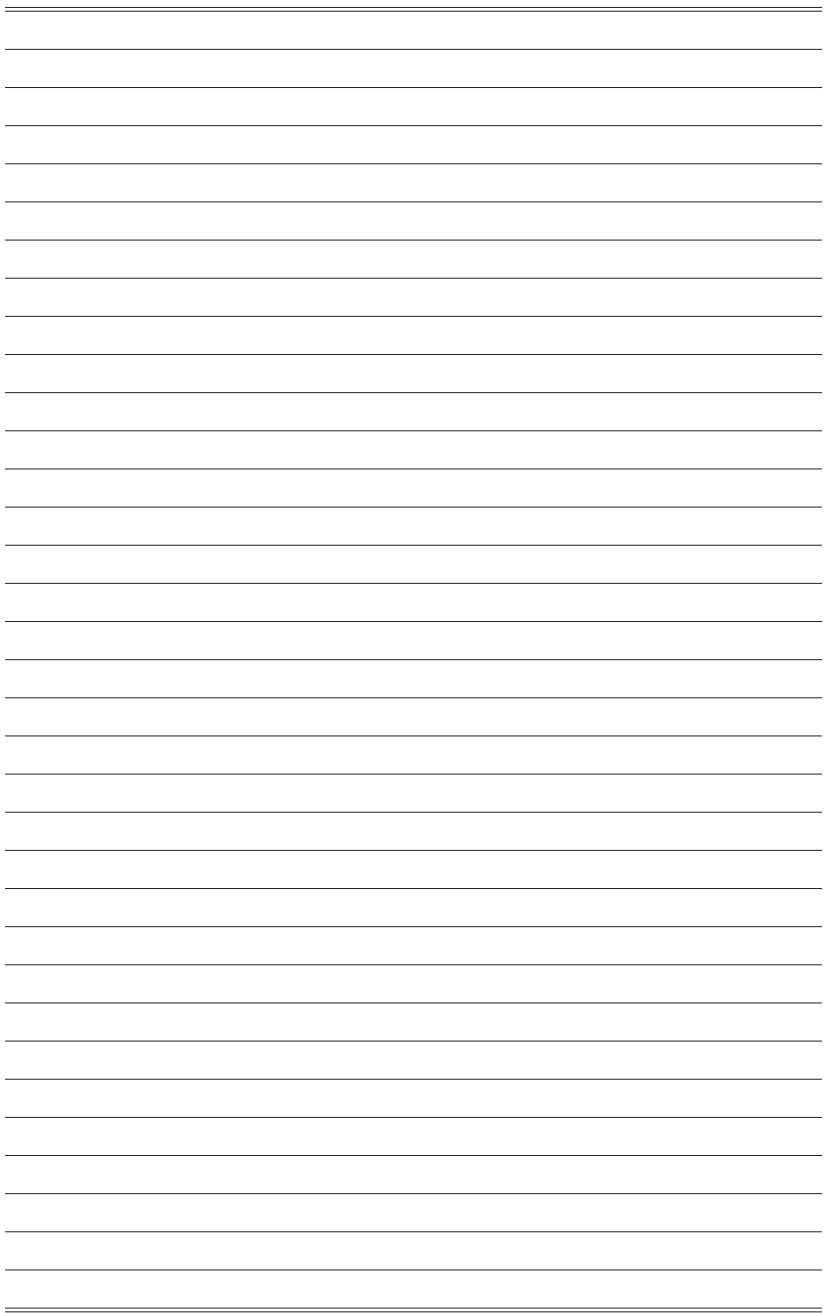

1 Overview



Thank you for choosing the MS-9B11, a high-performance automation computer from MSI.

A highly integrated, rugged system that features versatile I/O capability and PCIe expansion slots, the MS-9B11 is perfect for a wide variety of industrial applications, including machine automation, video surveillance, facility environment monitoring, intelligent transportation, etc.

System Overview



MS-9B11-S1



MS-9B11-S2

► System I/O & Controls

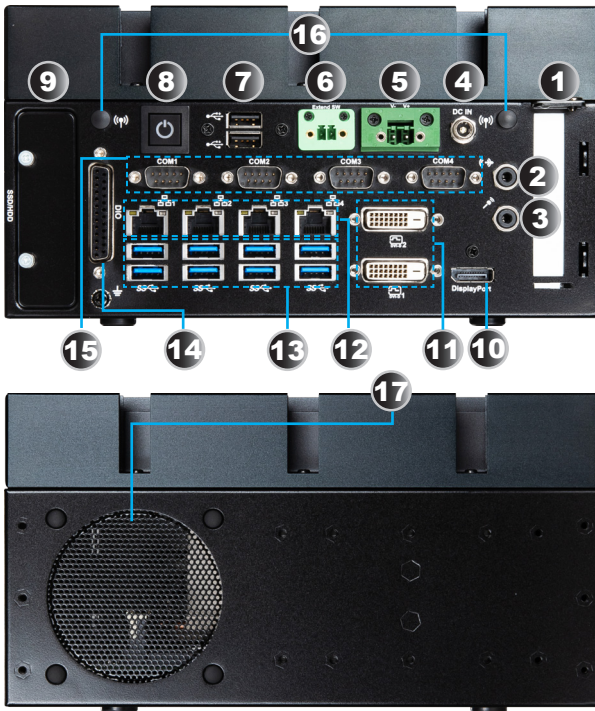

► Internal View

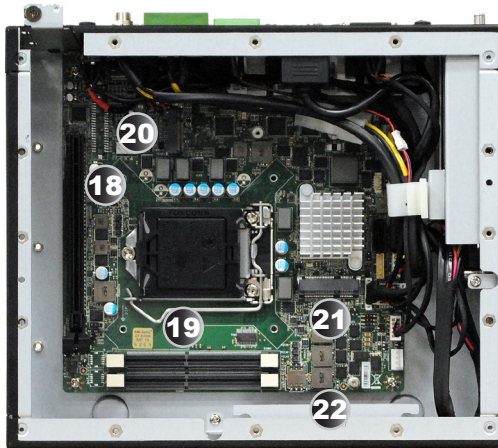

1 PCI-E Expansion Card Bracket

2 Line-Out Jack
This connector is provided for headphones or speakers.

3 Microphone Jack
This connector is provided for microphones.

4 Power Jack
Power supplied through this jack supplies power to the system.

Important

Your power source can either be connected to the Power Jack or the Phoenix DC Power Connector. Avoid connecting to both simultaneously.

5 Phoenix DC Power Connector
The system is designed with a Phoenix connector that carries DC input.

Important

Your power source can either be connected to the Power Jack or the Phoenix DC Power Connector. Avoid connecting to both simultaneously.

6 Extend Switch Connector
This connector is provided for remote power button control.

7 USB 2.0 Port
The USB (Universal Serial Bus) port is for attaching USB devices such as keyboard, mouse, or other USB-compatible devices. It supports up to 480Mbit/s (Hi-Speed) data transfer rate.

8 System Power Button
Press the system power button to turn the system on or off.

9 HDD Bracket
This bracket is provided for hard disk drives.

10 DisplayPort
DisplayPort is a digital display interface standard. This connector is used to connect a monitor with DisplayPort inputs.

11 DVI-I Port
The DVI-I (Digital Visual Interface-Integrated) connector allows you to connect an LCD monitor. It provides a high-speed digital interconnection between the computer and its display device. To connect an LCD monitor, simply plug your monitor cable into the DVI connector, and make sure that the other end of the cable is properly connected to your monitor (refer to your monitor manual for more information.)

12 RJ45 LAN Jack
The standard RJ-45 LAN jack is provided for connection to the Local Area Network (LAN). You can connect a network cable to it.



LED	Color	LED State	Condition
Left	Yellow	Off	LAN link is not established.
		On (steady state)	LAN link is established.
		On (blinking)	The computer is communicating with another computer on the LAN.
Right	Green	Off	10 Mbit/sec data rate is selected.
		On	100 Mbit/sec data rate is selected.
	Orange	On	1000 Mbit/sec data rate is selected.

13 USB 3.0 Port
The USB 3.0 port is backward-compatible with USB 2.0 devices. It supports up to 5Gbit/s (SuperSpeed) data transfer rate.

14**DIO Port**

This port is provided for the Digital Input/Output (DIO) peripheral module.

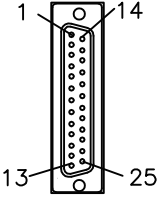
		PIN	SIGNAL	PIN	SIGNAL
1	GND	14	GND		
2	GPO0	15	GPI0		
3	GPO1	16	GPI1		
4	GPO2	17	GPI2		
5	GPO3	18	GPI3		
6	GPO4	19	GPI4		
7	GPO5	20	GPI5		
8	GPO6	21	GPI6		
9	GPO7	22	GPI7		
10	VCC5	23	VCC5		
11	NC	24	NC		
12	NC	25	NC		
13	NC				

15

RS-232/422/485 Serial Port: COM1(RI/5V/12V) / COM2~COM4 (0V/5V/12V)

The serial port is a 16550A high speed communications port that sends/ receives 16 bytes FIFOs. It supports barcode scanners, barcode printers, bill printers, credit card machine, etc.

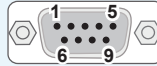

RS-232

PIN	SIGNAL	DESCRIPTION
1	NDCD	Data Carrier Detect
2	NSIN	Signal In
3	NSOUT	Signal Out
4	NDTR	Data Terminal Ready
5	GND	Signal Ground
6	NDSR	Data Set Ready
7	NRTS	Request To Send
8	NCTS	Clear To Send
9	VCC	5V or 12V selected by jumper

RS-422

PIN	SIGNAL	DESCRIPTION
1	422 TXD-	Transmit Data, Negative
2	422 RXD+	Receive Data, Positive
3	422 TXD+	Transmit Data, Positive
4	422 RXD-	Receive Data, Negative
5	GND	Signal Ground
6	NC	No Connection
7	NC	No Connection
8	NC	No Connection
9	NC	No Connection

RS-485

PIN	SIGNAL	DESCRIPTION
1	485 TXD-	Transmit Data, Negative
2	NC	No Connection
3	485 TXD+	Transmit Data, Positive
4	NC	No Connection
5	GND	Signal Ground
6	NC	No Connection
7	NC	No Connection
8	NC	No Connection
9	NC	No Connection

16**WLAN Antenna Connector (Optional)**

This connector allows you to connect an external antenna for wireless LAN.

17**Ventilator**

The ventilator is designed to cool the system. DO NOT block the ventilator for air circulation.

18**PCIe Expansion Slot**

These slots are provided for PCIe expansion cards.

To enable multi-screen output from integrated graphics and external graphics card, please set BIOS items as following.

1. Set CSM to Disable
2. Set Chipset/Primary Display to IGFX

19**Memory Slot**

These slots are intended for memory modules.

20**M.2 Slot**

The slot is used to install M.2 card.

21**Mini PCIe Slot**

The slot is used to install Mini PCIe card.

22**HDD Bracket**

The barcket is used to install 2.5" HDD.

System Specifications

Processor

- Intel® Kaby Lake-S Core™ i7, Core™ i5, Core™ i3, Pentium®, Celeron® Series Processor
- Intel® Sky Lake-S Core™ i7, Core™ i5, Core™ i3, Pentium®, Celeron® Series Processor

Chipset

- Intel® Q170

Memory

- 2 * DDR4 SO-DIMM slots
- Dual-Channel DDR4 Non-ECC memory up to 2400MHz
- Max 32GB

LAN

- Intel® I210AT GbE LAN

Storage

- 2 * SATA 6Gb/s ports
- 1 * M.2 Key (PCIe x4 NVMe, SATA3.0) 2242/2280 slot

Audio

- Realtek ALC887 audio codec (Co-lay ALC888S)
- 1 * Line-Out connector
- 1 * Mic-in connector

Graphics

- 2 * DVI-D (Max resolution 1920 x 1200@60Hz)
- 1 * DP (Max resolution 4096x2160@60Hz)
- 3 independent display output supported (DVI1+DVI2+DP)
- 2 independent display output supported (DVI1+DVI2, DVI1+DP, DVI2+DP)

System I/O & Controls

- 1 * Power Button
- 1 * 16bit Digital I/O Connector
- 1 * 12~24V DC Power Jack
- 1 * 12~24V Phoenix DC Power Connector
- 1 * Extension Power Switch Connector
- 2 * USB 2.0 Ports
- 8 * USB 3.0 Ports
- 1 * RS-232/422/485 Serial Port (COM1: RI/5V/12V)
- 3 * RS-232/422/485 Serial Port (COM2~4: 0V/5V/12V)
- 2 * DVI-D Port
- 1 * DisplayPorts
- 4 * RJ45 LAN Jacks
- 1 * Line_Out Jack
- 1 * Micphone Jack
- 2 * Antenna Holes

Expansion Slot

- 1 * PCIe x16 (Max. 75W Supported ; Low Profile Form Factor:167.65mm X 68.9mm Supported)

Power Supply

- Input: 12~24V, 15A-7.5A
- Important : The product doesn't support ErP standard (S5 Power consumption under 1W).

Environmental

- Operation Temperature:
 - » MS-9B11-S1: -10 ~ 45°C with CPU up to 35W
 - » MS-9B11-S2: -10 ~ 45°C with CPU up to 65W
- Storage Temperature: -20 ~ 80°C
- Relative Humidity: 10% ~ 90%, non-condensing

Dimension

- MS-9B11 S1: 235 (L) x 200 (W) x 125 (H) mm
- MS-9B11 S1: 235 (L) x 200 (W) x 88 (H) mm

Weight

- MS-9B11 S1: 4.43Kg
- MS-9B11 S1: 2.5Kg

Regulatory Compliance

- CE, FCC Class A, VCCI, RCM, BSMI, RoHS

OS Support

- Windows 10 IOT Enterprise 64-Bit
- Windows 8.1 64-Bit (For Skylake-S Series Only)
- Windows 7 32/64-Bit (For Skylake-S Series Only)

Motherboard Jumpers

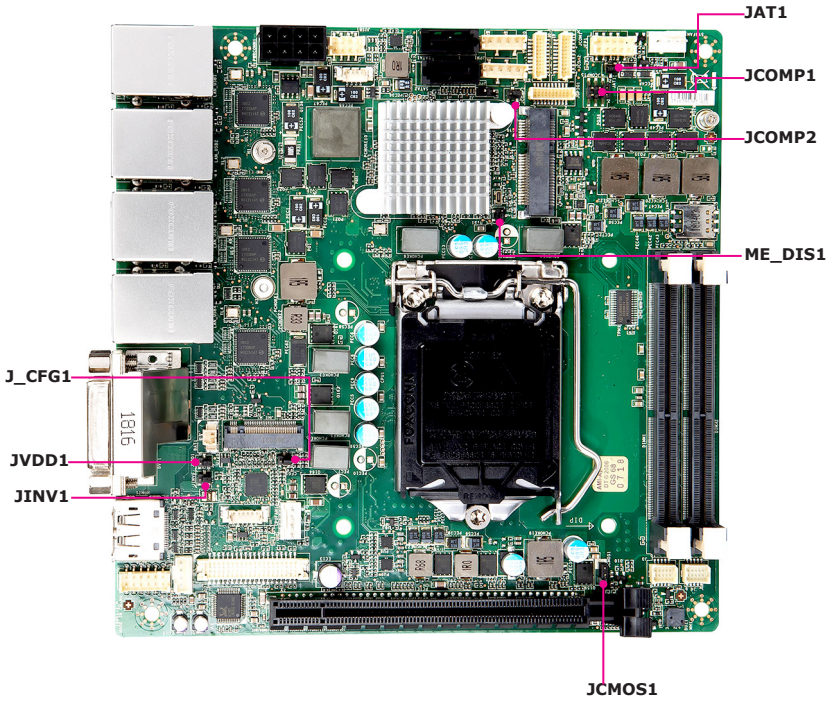

Important

Avoid adjusting jumpers when the system is on; it will damage the motherboard.

Clear CMOS Jumper: JCMOS1

There is a CMOS RAM onboard that has a power supply from an external battery to keep the data of system configuration. With the CMOS RAM, the system can automatically boot OS every time it is turned on. If you want to clear the system configuration, set the jumper to clear data.

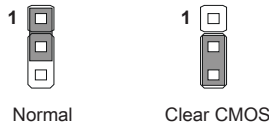
**Important**

You can clear CMOS by shorting 2-3 pin while the system is off. Then return to 1-2 pin position. Avoid clearing the CMOS while the system is on; it will damage the motherboard.

AT/ATX Jumper: JAT1

This jumper allows users to select between AT and ATX power.

**ME Jumper: ME_DIS1**

This jumper is used to enable/disable the Intel ME function.

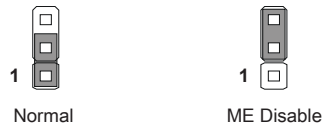

COM1 Power Jumper: JCOMP1

This jumper specifies the operation voltage of the COM1 serial port.

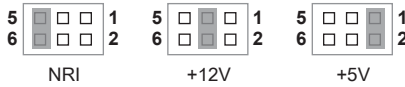

COM2~4 Power Jumper: JCOMP2

This jumper specifies the operation voltage of the COM2~4 serial ports.



LVDS Power Jumper: JVDD1

Use this jumper to specify the operation voltage of the LVDS interface flat panel.



LVDS Inverter Power Jumper: JINV1

Use this jumper to specify the operation voltage of the interver interface flat panel.



PCI Express Jumper: J_CFG1

This jumper specifies the operation speed of the PCI Express slot.



Mechanical Overview (MS-9B11-S1)

► System Dimensions

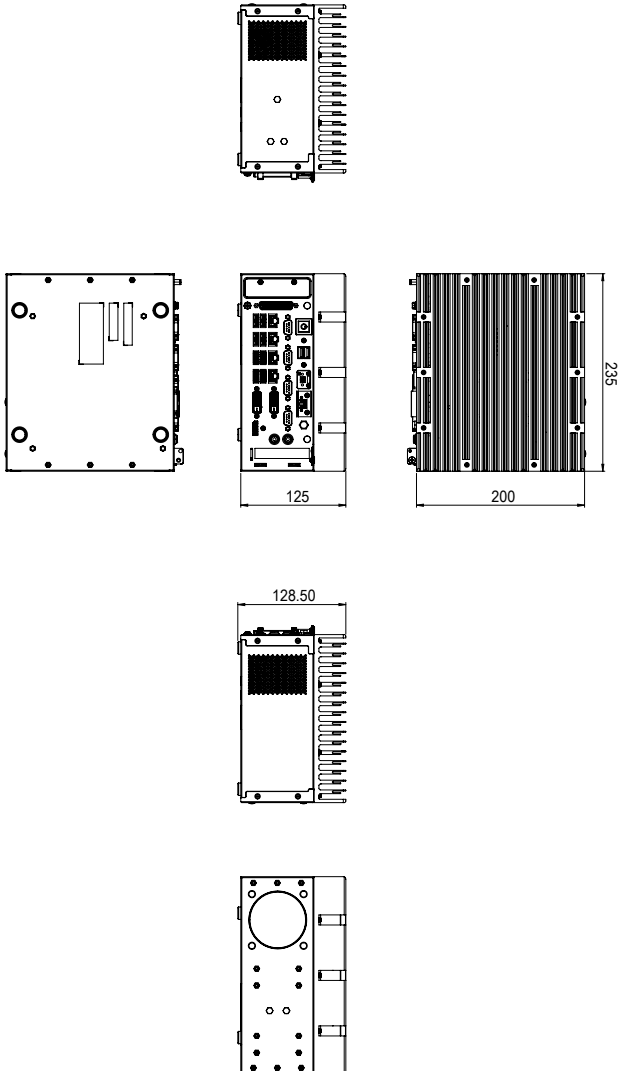

► System Dimensions with Wall Mount (Desktop)

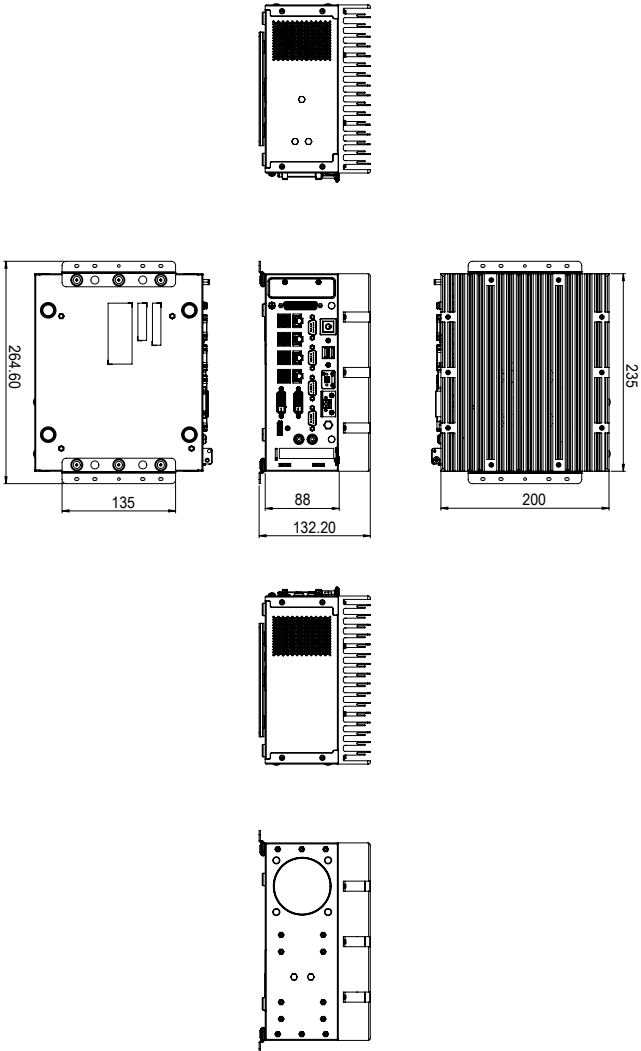

► System Dimensions with Wall Mount (Vertical)

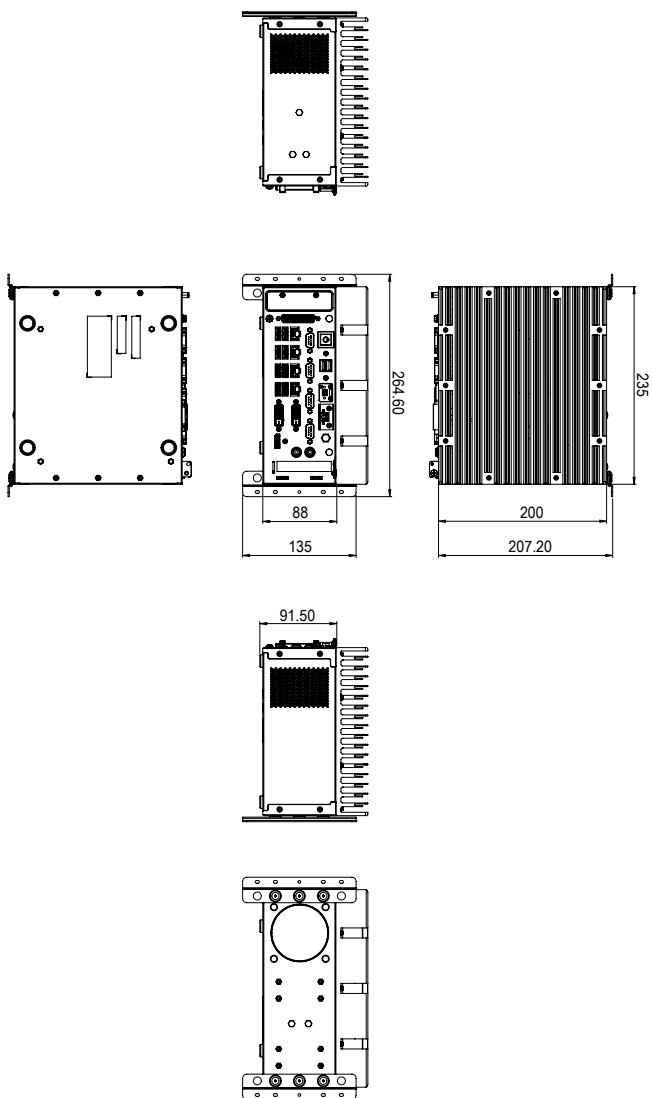

Mechanical Overview (MS-9B11-S2)

► System Dimensions

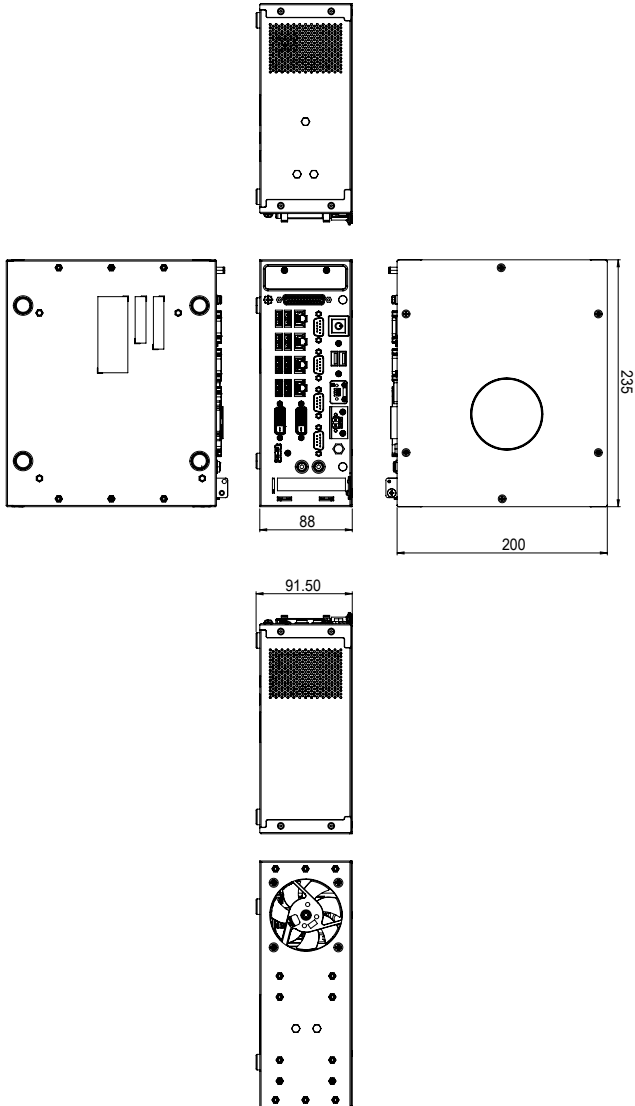

► System Dimensions with Wall Mount (Desktop)

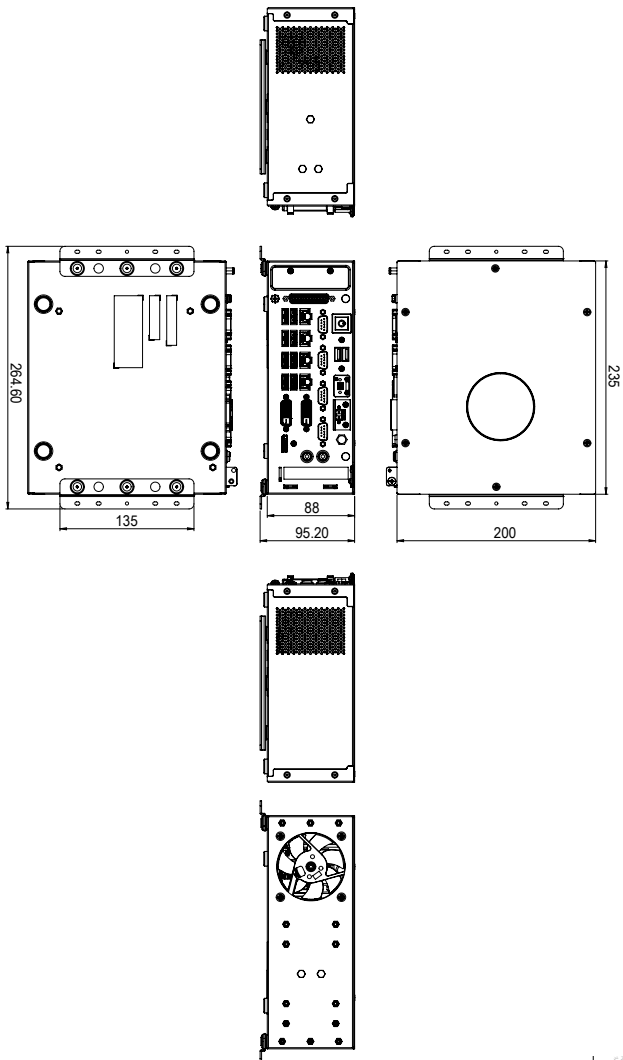

2 Getting Started



This chapter provides you with the information on hardware setup procedures. While connecting peripheral devices, be careful in holding the devices and use a grounded wrist strap to avoid static electricity.

Top Cover (MS-9B11-S1)

Important

Turn off the system and unplug the power cord before installing or replacing system components.

1. Locate and loosen the screws on the top panel of the system to release the top cover.



2. Remove the top cover from the system.

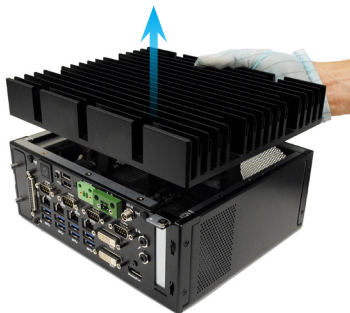

Top Cover (MS-9B11-S2)

Important

Turn off the system and unplug the power cord before installing or replacing system components.

1. Locate and loosen the screws on the top panel of the system to release the top cover.

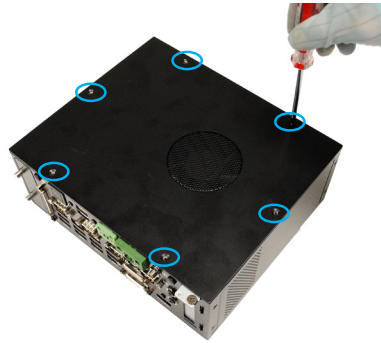

2. Remove the top cover from the system.

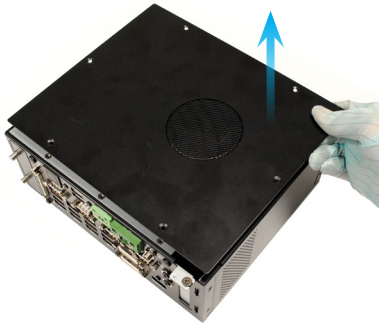

CPU

When installing the CPU, make sure that you install the cooler to prevent overheating. If you do not have the CPU cooler, consult your dealer before turning on the computer.

Important

Overheating

Overheating will seriously damage the CPU and system. Always make sure the cooling fan can work properly to protect the CPU from overheating. Make sure that you apply an even layer of thermal paste (or thermal tape) between the CPU and the heatsink to enhance heat dissipation.

Replacing the CPU

While replacing the CPU, always turn off the power supply or unplug the power supply's power cord from the grounded outlet first to ensure the safety of CPU.

Introduction to LGA 115x CPU

The surface of LGA 115x CPU. Remember to apply some thermal paste on it for better heat dispersion.

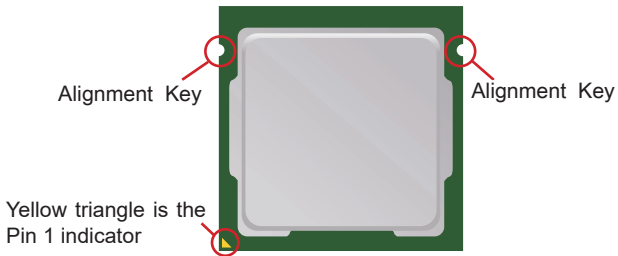

1. Push the load lever down to unclip it and lift to the fully open position.
2. The load plate will automatically lift up as the load lever is pushed to the fully open position.

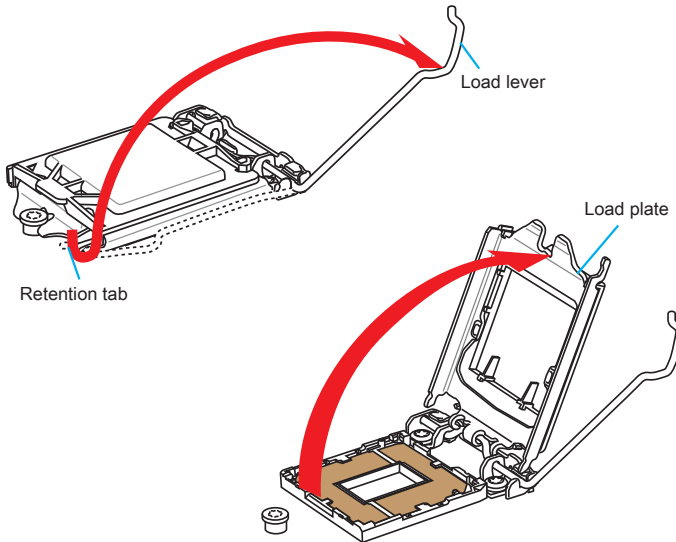

 *Important*

Do not touch the socket contacts or the bottom of the CPU.

3. Align the notches with the socket alignment keys. Lower the CPU straight down, without tilting or sliding the CPU in the socket. Inspect the CPU to check if it is properly seated in the socket.
4. Close and slide the load plate under the retention knob. Close and engage the load lever.

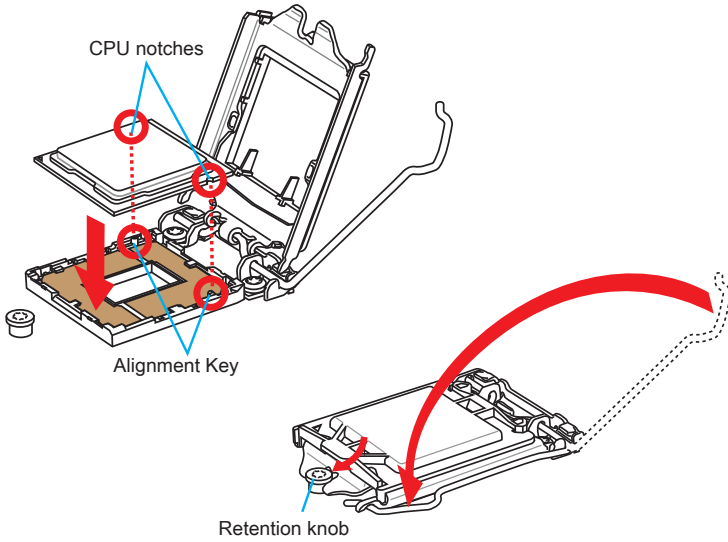

- When you press down the load lever the PnP cap will automatically pop up from the CPU socket. Do not discard the PnP cap. Always replace the PnP cap if the CPU is removed from the socket.

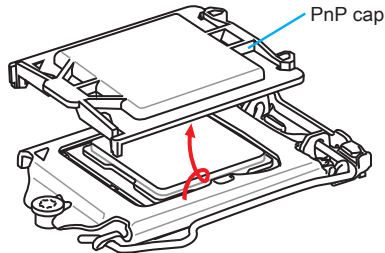

 **Important**

- Whenever the CPU is not installed, always protect the CPU socket pins by covering the socket with the plastic cap.

Installing Heatsink (MS-9B11-S1)

- Peel off the transparent protective film of the thermal pad. Remove the protective cap from the heatsink.

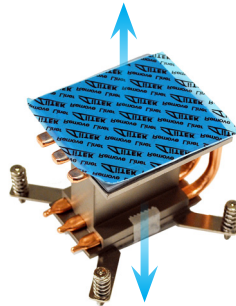

2. Align the holes on the motherboard with the heatsink.



3. Lock the screws in the assigned diagonal sequences.

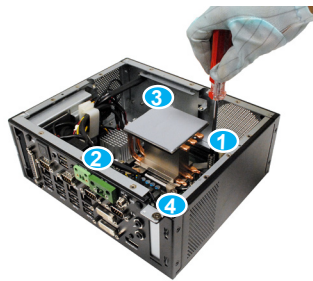

4. Align the copper plate under the top cover with the thermal pad on the heatsink.



5. Place the top cover and lock the screws.



Installing Cooler (MS-9B11-S2)

1. Remove the protective cap from the cooler.

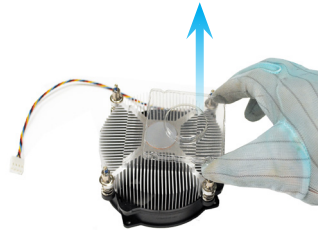

2. Connect the cooler power.



3. Align the holes on the motherboard with the cooler.



4. Align the holes on the motherboard with the heatsink. Lock the screws in the assigned diagonal sequences.



-
5. Align the ventilator on the top cover with the cooler.

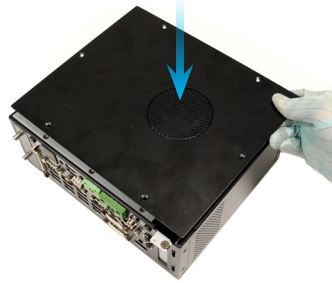

-
6. Place the top cover and lock the screws.

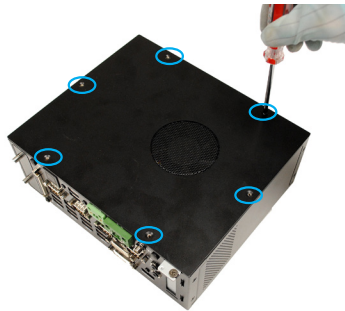

Memory

1. Locate the memory slot. Push the clips outwards.

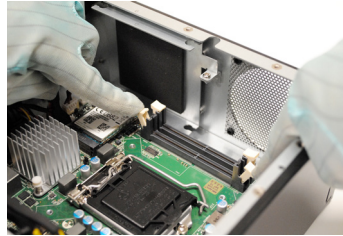

2. Align the notch on the memory with the key on the slot and insert the memory into the slot.



3. Push the memory gently downwards until the slot clips click and lock the memory in place.



Hard Disk Drive (Internal)

1. Unlock the HDD bracket screw.



2. Follow the direction to slide HDD bracket.

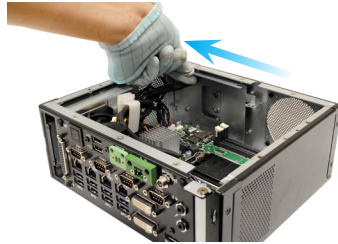

3. Take the HDD bracket out.

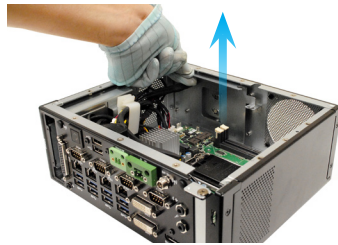

4. Find the thermal pad in the accessory box. Peel off one side of the transparent protective film and paste it to the HDD barcket.

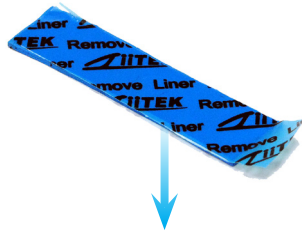

-
5. Insert the rubber pad to the HDD bracket.

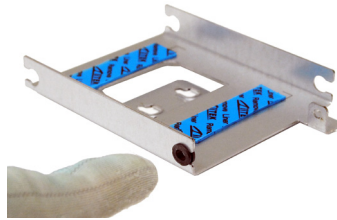

-
6. Insert other rubber pads as well.

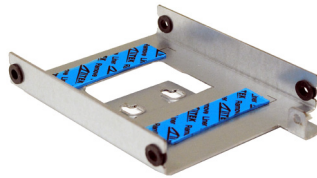

-
7. Peel off the transparent protective film of the thermal pad.

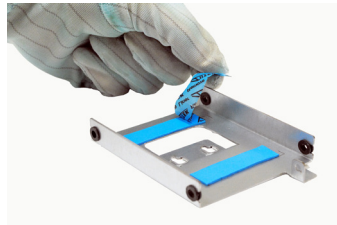

-
8. Fit the HDD into the bracket. Be sure to put the HDD in the correct orientation.



-
9. Fix the HDD to the bracket with screws.



-
10. Connect SATA data cable and power cable to the HDD.

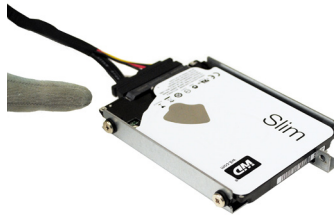

-
11. Connect SATA data cable and power cable to the motherboard.

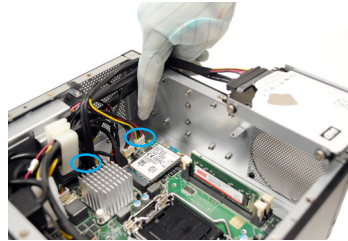

12. Follow the direction to replace the HDD set.



13. Follow the direction to slide HDD set till the marks on the bracket and chassis are aligned.



14. Fix the HDD set to the chassis with screw.



Hard Disk Drive (External)

1. Unlock the HDD bracket screws.



2. Take the HDD bracket out.



3. Insert the rubber pads to the HDD bracket.



-
4. Fit the HDD into the bracket.
Be sure to put the HDD in the correct orientation.



-
5. Fix the HDD to the bracket with screws.



-
6. Follow the direction to replace the HDD set. Push the HDD set gently to secure it in place.



-
7. Lock the HDD bracket screws.



PCIe Expansion Card

1. Unlock the PCIe slot bracket screws.

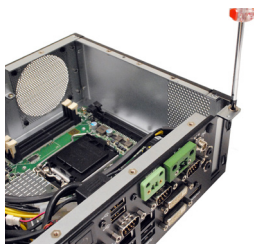

2. Remove the PCIe slot bracket.

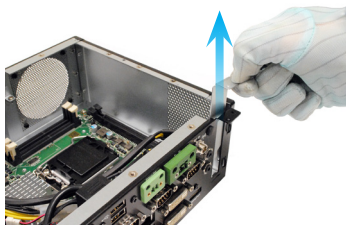

3. Insert the PCIe expansion card into the slot.

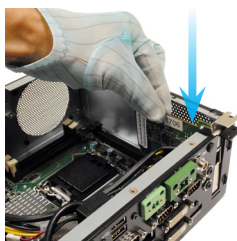

4. Lock the PCIe expansion card with screw.

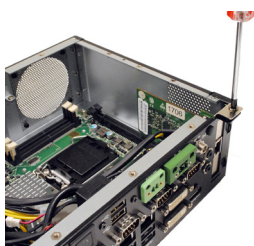

Mini PCIe WiFi Card (Optional)

Important

For Mini PCIe cards that draw power from the motherboard, make sure they operate at exactly the same voltage as the system power source.

1. Remove the rubber protector from the panel.

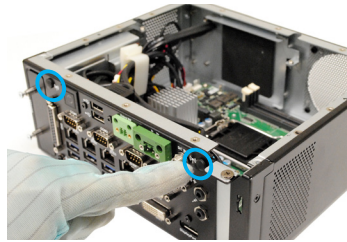

2. Lead the connector of the antenna cable through the hole.

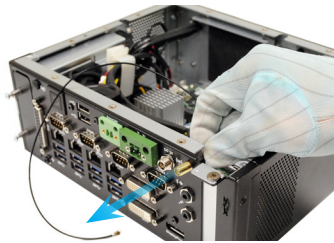

3. Assemble the antenna cable to the panel. Put a washer then a nut and follow the direction to fasten the antenna cable.-



4. Install the other antenna cable as well.



5. Connect the antenna cables to the Mini PCIe WiFi card.

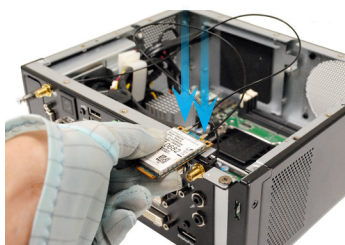

6. Locate the Mini PCIe slot. Remove the Mini PCIe screw preinstalled on the motherboard.

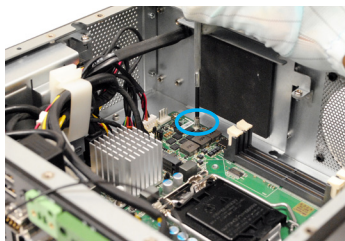

7. Insert the Mini PCIe WiFi card into the slot at a 45-degree angle.

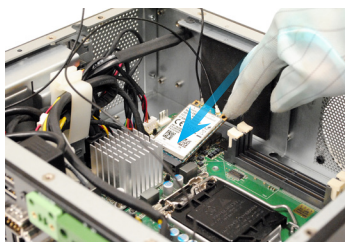

8. Push the card gently downwards and fasten it with a screw.

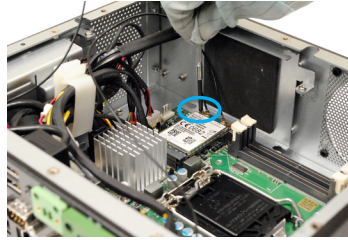

9. Reroute the antenna cables.

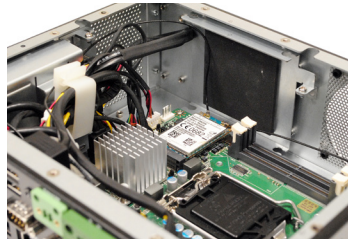

M.2 Slot (Key M, 2280 & 2242)

1. Please install the M.2 solid-state drive (SSD) into the M.2 slot as shown below.

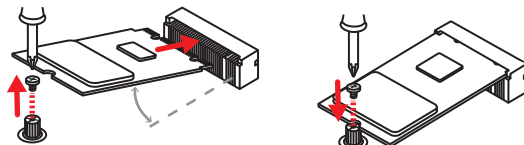

Important

- Intel® RST only supports PCIe M.2 SSD with UEFI ROM and does not support Legacy ROM.
 - When adding or removing expansion cards, make sure that you unplug the power supply first. Meanwhile, read the documentation for the expansion card to configure any necessary hardware or software settings for the expansion card, such as jumpers, switches or BIOS configuration.
-

Mounting Brackets (Desktop)

1. Insert the rubber pad to the mounting bracket.



2. Screw the brackets to the system.

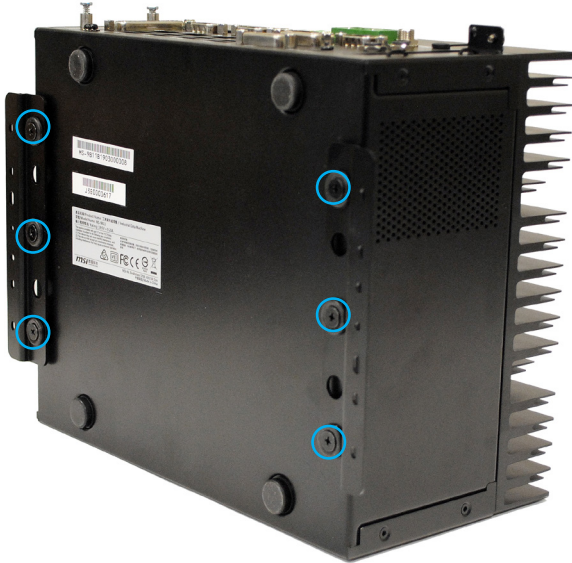

Mounting Brackets (Vertical)

1. Insert the rubber pad to the mounting bracket.



2. Screw the brackets to the system. MS-9B11-S2 doesn't support Mounting Brackets (Vertical).



Power (Optional)

With a redundant power supply solution, users may feed the power through the DC power jack and/or through the 12V~24V Phoenix DC connector.

1. Locate the DC power connector on the system panel.



2. Connect a DC receptacle connector to it.



Extension Power Switch (Optional)

This connector can be used to make an extensive power switch.

1. Locate the connector on the system panel.



2. Connect an extension power switch connector to it.



DIN Rail (Optional)

1. Put the DIN rail on the chassis with the screw holes aligned.

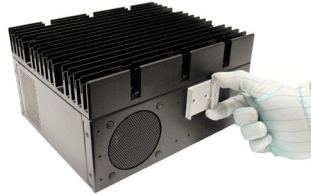

2. Lock the DIN rail with the screws.



3. Install the other DIN rail as well. It is recommended that the machine be 1 cm away from the wall.



4. The other position of DIN rail installation. The distance between the machine and the wall is less than 1 cm.

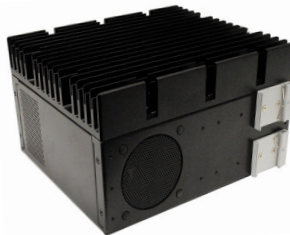

3 BIOS Setup

This chapter provides information on the BIOS Setup program and allows users to configure the system for optimal use.

Users may need to run the Setup program when:

- An error message appears on the screen at system startup and requests users to run SETUP.
- Users want to change the default settings for customized features.

Important

- *Please note that BIOS update assumes technician-level experience.*
- *As the system BIOS is under continuous update for better system performance, the illustrations in this chapter should be held for reference only.*

Entering Setup

Power on the computer and the system will start POST (Power On Self Test) process. When the message below appears on the screen, press or <F2> key to enter Setup.

Press or <F2> to enter SETUP

If the message disappears before you respond and you still wish to enter Setup, restart the system by turning it OFF and On or pressing the RESET button. You may also restart the system by simultaneously pressing <Ctrl>, <Alt>, and <Delete> keys.

Important

The items under each BIOS category described in this chapter are under continuous update for better system performance. Therefore, the description may be slightly different from the latest BIOS and should be held for reference only.

Control Keys

← →	Select Screen
↑ ↓	Select Item
Enter	Select
+ -	Change Option
F1	General Help
F7	Previous Values
F9	Optimized Defaults
F10	Save & Reset
Esc	Exit

Getting Help

After entering the Setup menu, the first menu you will see is the Main Menu.

Main Menu

The main menu lists the setup functions you can make changes to. You can use the arrow keys (↑ ↓) to select the item. The on-line description of the highlighted setup function is displayed at the bottom of the screen.

Sub-Menu

If you find a right pointer symbol appears to the left of certain fields that means a sub-menu can be launched from this field. A sub-menu contains additional options for a field parameter. You can use arrow keys (↑ ↓) to highlight the field and press <Enter> to call up the sub-menu. Then you can use the control keys to enter values and move from field to field within a sub-menu. If you want to return to the main menu, just press the <Esc >.

General Help <F1>

The BIOS setup program provides a General Help screen. You can call up this screen from any menu by simply pressing <F1>. The Help screen lists the appropriate keys to use and the possible selections for the highlighted item. Press <Esc> to exit the Help screen.

The Menu Bar

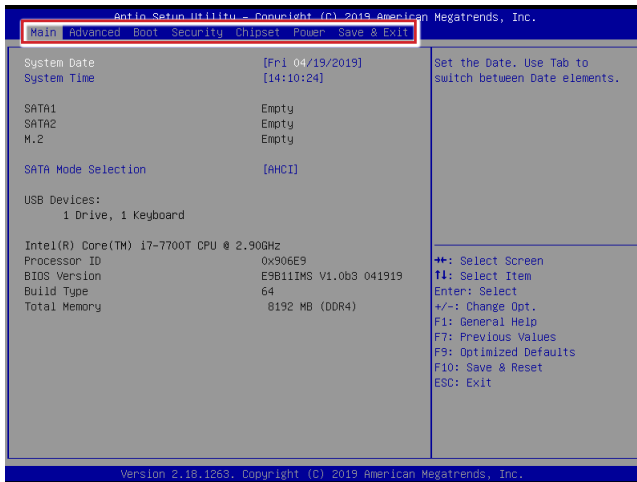

► Main

Use this menu for basic system configurations, such as time, date, etc.

► Advanced

Use this menu to set up the items of special enhanced features.

► Boot

Use this menu to specify the priority of boot devices.

► Security

Use this menu to set supervisor and user passwords.

► Chipset

This menu controls the advanced features of the onboard chipsets.

► Power

Use this menu to specify your settings for power management.

► Save & Exit

This menu allows you to load the BIOS default values or factory default settings into the BIOS and exit the BIOS setup utility with or without changes.

Main

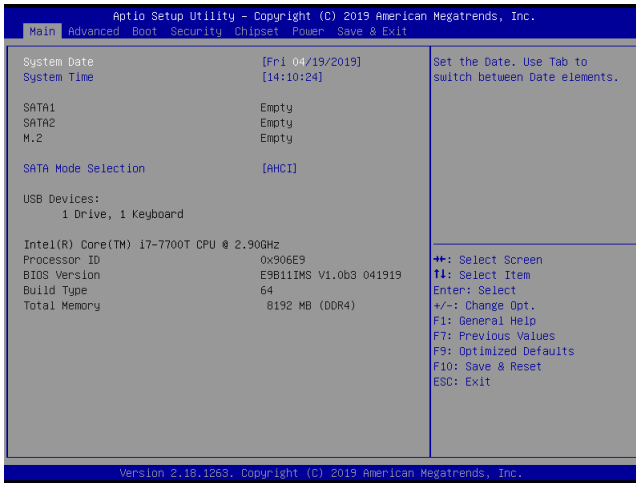

► System Date

This setting allows you to set the system date. The date format is <Day>, <Month> <Date> <Year>.

► System Time

This setting allows you to set the system time. The time format is <Hour> <Minute> <Second>.

► SATA Mode Selection

This setting specifies the SATA controller mode.

Advanced

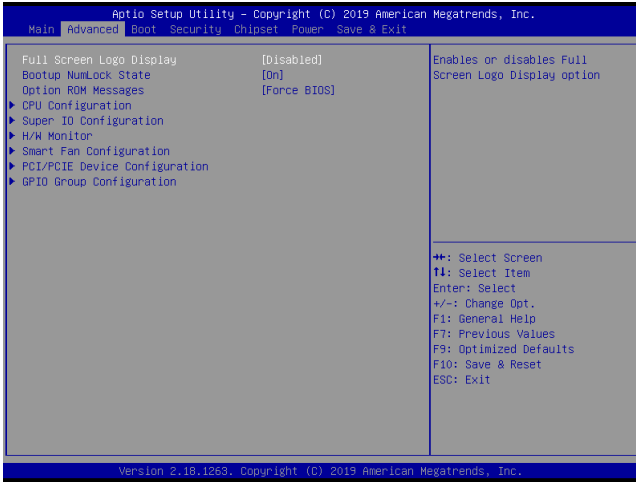

► Full Screen Logo Display

This BIOS feature determines if the BIOS should hide the normal POST messages with the motherboard or system manufacturer's full-screen logo.

When it is enabled, the BIOS will display the full-screen logo during the boot-up sequence, hiding normal POST messages.

When it is disabled, the BIOS will display the normal POST messages, instead of the full-screen logo.

Please note that enabling this BIOS feature often adds 2-3 seconds of delay to the booting sequence. This delay ensures that the logo is displayed for a sufficient amount of time. Therefore, it is recommended that you disable this BIOS feature for a faster boot-up time.

► Bootup NumLock State

This setting is to set the Num Lock status when the system is powered on. Setting to [On] will turn on the Num Lock key when the system is powered on. Setting to [Off] will allow users to use the arrow keys on the numeric keypad.

► Option ROM Messages

This item is used to determine the display mode when an optional ROM is initialized during POST. When set to [Force BIOS], the display mode used by AMI BIOS is used. Select [Keep Current] if you want to use the display mode of optional ROM.

► CPU Configuration

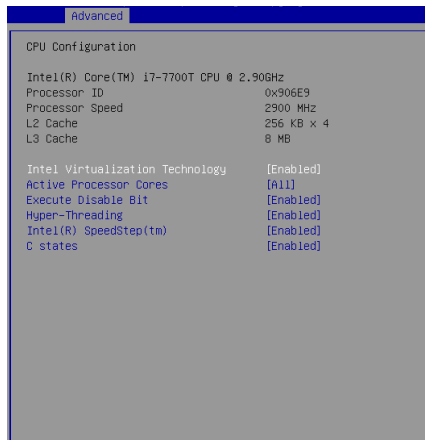

► Intel Virtualization Technology

Virtualization enhanced by Intel Virtualization Technology will allow a platform to run multiple operating systems and applications in independent partitions. With virtualization, one computer system can function as multiple “Virtual” systems.

► Active Processor Cores

This setting specifies the number of active processor cores.

► Execute Disable Bit

Intel’s Execute Disable Bit functionality can prevent certain classes of malicious “buffer overflow” attacks when combined with a supporting operating system. This functionality allows the processor to classify areas in memory by where application code can execute and where it cannot. When a malicious worm attempts to insert code in the buffer, the processor disables code execution, preventing damage or worm propagation.

► Hyper-Threading

The processor uses Hyper-Threading technology to increase transaction rates and reduces end-user response times. The technology treats the two cores inside the processor as two logical processors that can execute instructions simultaneously. In this way, the system performance is highly improved. If you disable the function, the processor will use only one core to execute the instructions. Please disable this item if your operating system doesn’t support HT Function, or unreliability and instability may occur.

► Intel(R) SpeedStep(tm)

EIST (Enhanced Intel SpeedStep Technology) allows the system to dynamically adjust processor voltage and core frequency, which can result in decreased average power consumption and decreased average heat production. When disabled, the processor will return the actual maximum CPUID input value of the processor when queried.

► C States

This setting controls the C-State (CPU Power state). C-State performance indicates the ability to run the processor in lower power states when the PC is idle. This setting enables/disables the C-State Configuration for power saving purposes.

► Super IO Configuration



► Serial Port 1/ 2/ 3/ 4

This setting enables/disables the specified serial port.

► Change Settings

This setting is used to change the address & IRQ settings of the specified serial port.

► Mode Select

Select an operation mode for the specified serial port.

► Watch Dog Timer

You can enable the system watch-dog timer, a hardware timer that generates a reset when the software that it monitors does not respond as expected each time the watch dog polls it.

► FIFO Mode

This setting controls the FIFO data transfer mode.

► Shared IRQ Mode

This setting provides the system with the ability to share interrupts among its serial ports.

► H/W Monitor

These items display the current status of all monitored hardware devices/components such as voltages, temperatures and all fans' speeds.

Advanced	
PC Health Status	
Thermal Shutdown	[Disabled]
CPU temperature	: +75 C
System temperature	: +41 C
CPUFAN1	: 7246 RPM
SYSFAN1	: N/A
VCC_CORE	: +0.896 V
VCC3	: +3.288 V
VCC5	: +4.961 V
+12V	: +11.880 V
VCC3V	: +3.280 V
VSB3V	: +3.296 V
VSB5V	: +4.920 V
VBAT	: +3.104 V

► Thermal Shutdown

This setting enables/disables the thermal shutdown function for system thermal protection.

► Smart Fan Configuration

Advanced	
Configuration Smart FAN	
CPUFAN1	[Disabled]
SYSFAN1	[Disabled]

► CPUFAN1, SYSFAN1

This setting enables/disables the Smart Fan function. Smart Fan is an excellent feature which will adjust the CPU/system fan speed automatically depending on the current CPU/system temperature, avoiding the overheating to damage your system.

► **PCI/PCIE Device Configuration**

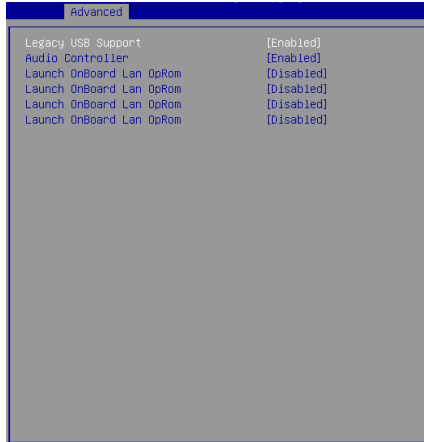

► **Legacy USB Support**

Set to [Enabled] if you need to use any USB 1.1/2.0 device in the operating system that does not support or have any USB 1.1/2.0 driver installed, such as DOS and SCO Unix.

► **Audio Controller**

This setting enables/disables the onboard audio controller.

► **Launch OnBoard LAN OpROM**

These settings enable/disable the initialization of the onboard/onchip LAN Boot ROM during bootup. Selecting [Disabled] will speed up the boot process.

▶ GPIO Group Configuration

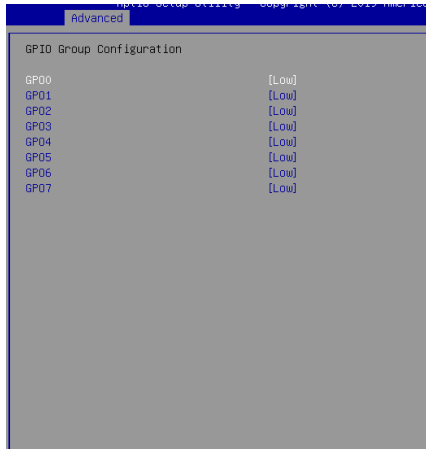

▶ GPIO0 ~ GPIO7

These settings control the operation mode of the specified GPIO.

Boot

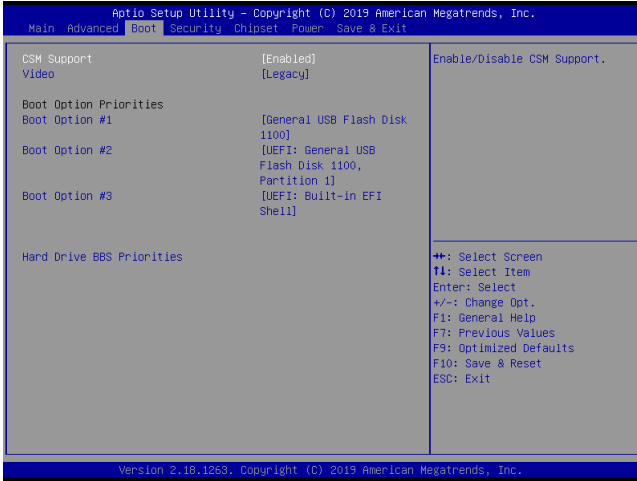

► **CSM Support**

This setting enables/disables the support for Compatibility Support Module, a part of the Intel Platform Innovation Framework for EFI providing the capability to support legacy BIOS interfaces.

► **Video**

This setting selects the video mode.

► **Boot Option Priorities**

This setting allows users to set the sequence of boot devices where BIOS attempts to load the disk operating system.

► **Hard Drive BBS Priorities**

This setting allows users to set the priority of the specified devices. First press <Enter> to enter the sub-menu. Then you may use the arrow keys (↑↓) to select the desired device, then press <+>, <-> or <PageUp>, <PageDown> key to move it up/down in the priority list.

Security

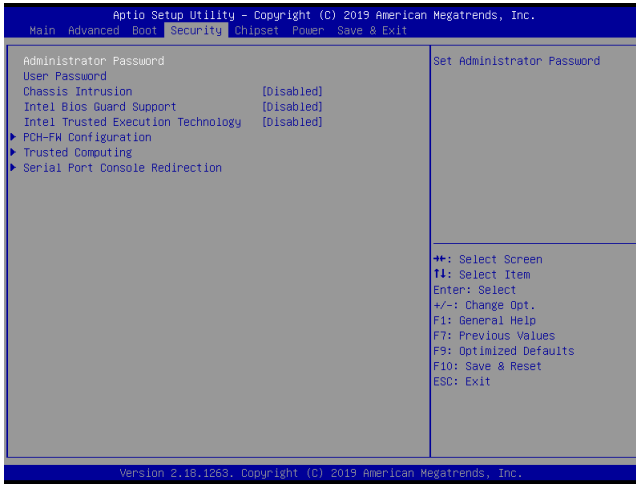

► Administrator Password

Administrator Password controls access to the BIOS Setup utility.

► User Password

User Password controls access to the system at boot and to the BIOS Setup utility.

► Chassis Intrusion

The field enables or disables the feature of recording the chassis intrusion status and issuing a warning message if the chassis is once opened.

► Intel BIOS Guard Support

Intel BIOS Guard Support ensures that updates to system BIOS flash are secure.

► Intel Trusted Execution Technology

Intel Trusted Execution Technology provides highly scalable platform security in physical and virtual infrastructures.

► PCH-FW Configuration

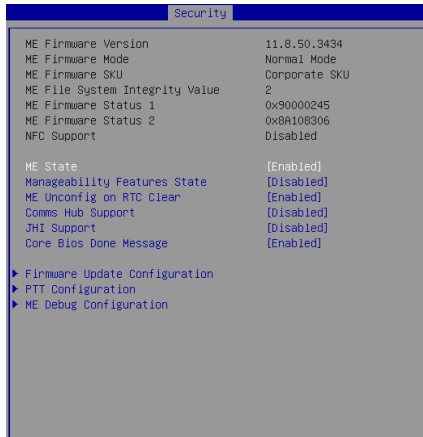

► ME Firmware Version, ME Firmware Mode, ME Firmware SKU, ME File System Integrity Value, ME Firmware Status 1, ME Firmware Status 2, NFC Support

These settings show the firmware information of the Intel ME (Management Engine).

► ME State

This setting enables/disables the ME status.

► Manageability Features State

This setting enables/disables the Manageability Features State.

► ME Unconfig on RTC Clear

This setting enables/disables ME firmware unconfigure on RTC clear.

► Comms Hub Support

This setting enables/disables Communications Hub Support.

► JHI Support

This setting enables/disables support for Intel Dynamic Application Loader Host Interface (JHI).

► Core BIOS Done Message

This setting enables/disables Core BIOS Done Message sent to ME.

► Firmware Update Configuration



► ME FW Image Re-Flash

This setting enables/disables the ME FW image reflash.

► PTT Configuration

Intel Platform Trust Technology (PTT) is a platform functionality for credential storage and key management used by Microsoft Windows.



► ME Debug Configuration

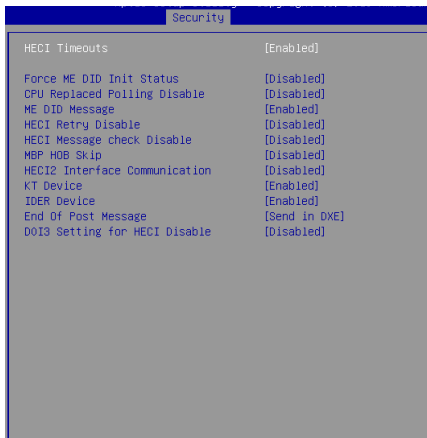

► Trusted Computing

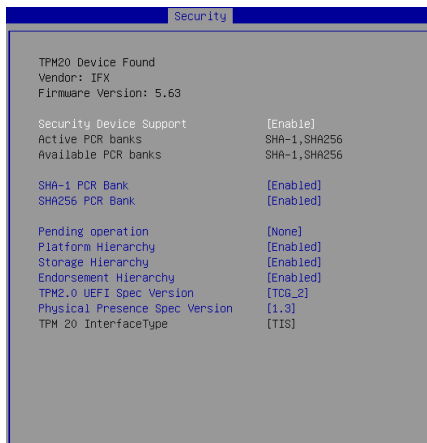

► Security Device Support

This setting enables/disables BIOS support for security device. When set to [Disable], the OS will not show security device. TCG EFI protocol and INT1A interface will not be available.

► SHA-1 PCR Bank, SHA256 PCR Bank

These settings enable/disable the SHA-1 PCR Bank and SHA256 PCR Bank.

► Pending Operation

When **Security Device Support** is set to [Enable], **Pending Operation** will appear. Set this item to [TPM Clear] to clear all data secured by TPM or [None] to discard the selection. It is advised that users should routinely back up their TPM secured data.

► **Platform Hierarchy, Storage Hierarchy, Endorsement Hierarchy**

These settings enable/disable the Platform Hierarchy, Storage Hierarchy and Endorsement Hierarchy.

► **TPM2.0 UEFI Spec Version, Physical Presence Spec Version**

This settings show the TPM2.0 UEFI Spec Version and Physical Presence Spec Version.

► **TPM2.0 Interface Type**

This setting shows the TPM2.0 Interface Type.

► **Serial Port Console Redirection**



COM1

► **Console Redirection**

Console Redirection operates in host systems that do not have a monitor and keyboard attached. This setting enables/disables the operation of console redirection. When set to [Enabled], BIOS redirects and sends all contents that should be displayed on the screen to the serial COM port for display on the terminal screen. Besides, all data received from the serial port is interpreted as keystrokes from a local keyboard.

► **Console Redirection Settings**

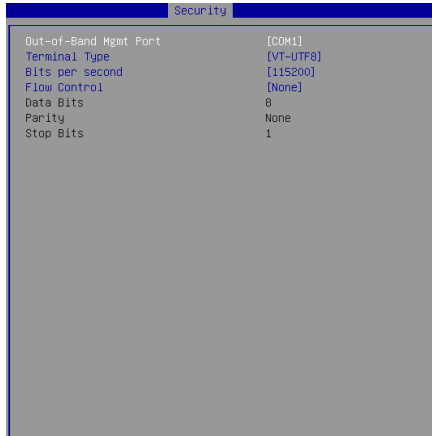

► **Out-of-Band Mgmt Port**

This setting specifies the Out-of-Band Management Port.

► **Terminal Type**

To operate the system's console redirection, you need a terminal supporting ANSI terminal protocol and a RS-232 null modem cable connected between the host system and terminal(s). This setting specifies the type of terminal device for console redirection.

► **Bits per second, Data Bits, Parity, Stop Bits**

This setting specifies the transfer rate (bits per second, data bits, parity, stop bits) of Console Redirection.

► **Flow Control**

Flow control is the process of managing the rate of data transmission between two nodes. It's the process of adjusting the flow of data from one device to another to ensure that the receiving device can handle all of the incoming data. This is particularly important where the sending device is capable of sending data much faster than the receiving device can receive it.

Legacy Console Redirection

▸ Legacy Console Redirection Settings

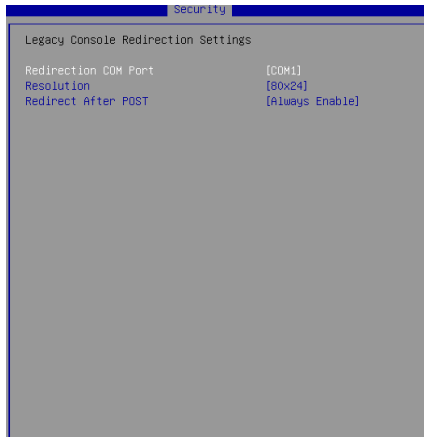

▸ Redirection COM Port

This setting specifies the COM port for redirection.

▸ Resolution

This setting specifies the redirection resolution of legacy OS.

▸ Redirect After POST

This setting determines whether or not to keep terminals' console redirection running after the POST has booted.

Serial Port for Out-of-Band Management/ Windows Emergency Management Services (EMS)

► Console Redirection

Console Redirection operates in host systems that do not have a monitor and keyboard attached. This setting enables/disables the operation of console redirection. When set to [Enabled], BIOS redirects and sends all contents that should be displayed on the screen to the serial COM port for display on the terminal screen. Besides, all data received from the serial port is interpreted as keystrokes from a local keyboard.

► Console Redirection Settings



► Out-of-Band Mgmt Port

This setting specifies the Out-of-Band Management Port.

► Terminal Type

To operate the system's console redirection, you need a terminal supporting ANSI terminal protocol and a RS-232 null modem cable connected between the host system and terminal(s). This setting specifies the type of terminal device for console redirection.

► Bits per second, Data Bits, Parity, Stop Bits

This setting specifies the transfer rate (bits per second, data bits, parity, stop bits) of Console Redirection.

► Flow Control

Flow control is the process of managing the rate of data transmission between two nodes. It's the process of adjusting the flow of data from one device to another to ensure that the receiving device can handle all of the incoming data. This is particularly important where the sending device is capable of sending data much faster than the receiving device can receive it.

Chipset

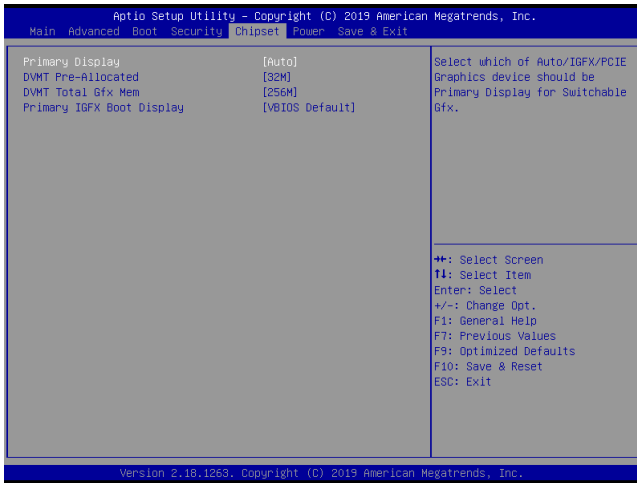

► Primary Display

Use the field to select the type of device you want to use as the display(s) of the system.

► DVMT Pre-Allocated

This setting selects DVMT 5.0 Pre-Allocated (Fixed) Graphics Memory size used by the Internal Graphics Device.

► DVMT Total Gfx Mem

This setting specifies the memory size for DVMT.

► Primary IGFX Boot Display

Use the field to select the primary IGFX boot display of the system.

Power

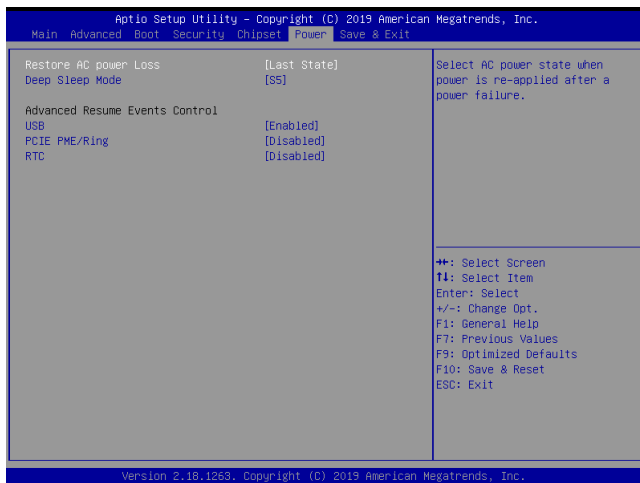

► Restore AC Power Loss

This setting specifies whether your system will reboot after a power failure or interrupt occurs. Available settings are:

[Power Off]	Leaves the computer in the power off state.
[Power On]	Leaves the computer in the power on state.
[Last State]	Restores the system to the previous status before power failure or interrupt occurred.

► Deep Sleep Mode

The setting enables/disables the Deep S5 power saving mode. S5 is almost the same as G3 Mechanical Off, except that the PSU still supplies power, at a minimum, to the power button to allow return to S0. A full reboot is required. No previous content is retained. Other components may remain powered so the computer can “wake” on input from the keyboard, clock, modem, LAN, or USB device.

**** Advanced Resume Events Control ******▶ USB**

The item allows the activity of the USB device to wake up the system from S3/S4 sleep state.

▶ PCIE PME/Ring

This field specifies whether the system will be awakened from power saving modes when activity or input signal of onboard PCIE PME/Ring is detected.

▶ RTC

When [Enabled], you can set the date and time at which the RTC (real-time clock) alarm awakens the system from suspend mode.

Save & Exit

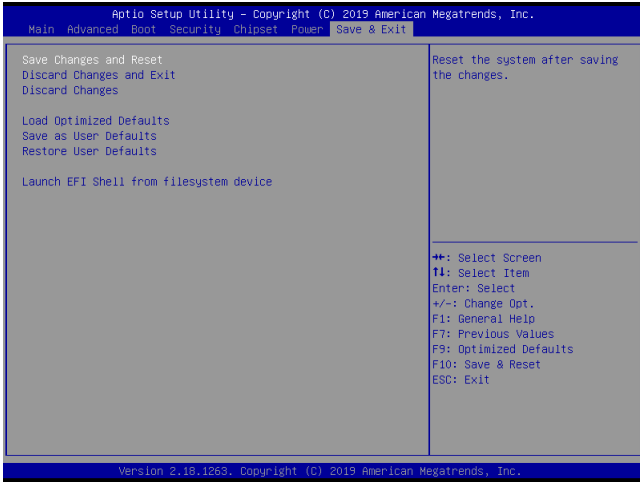

► Save Changes and Reset

Save changes to CMOS and reset the system.

► Discard Changes and Exit

Abandon all changes and exit the Setup Utility.

► Discard Changes

Abandon all changes.

► Load Optimized Defaults

Use this menu to load the default values set by the motherboard manufacturer specifically for optimal performance of the motherboard.

► Save as User Defaults

Save changes as the user's default profile.

► Restore User Defaults

Restore the user's default profile.

► Launch EFI Shell from filesystem device

This setting helps to launch the EFI Shell application from one of the available file system devices.

Appendix

GPIO WDT BKL Programming



This appendix provides WDT (Watch Dog Timer), GPIO (General Purpose Input/ Output) and LVDS Backlight programming guide.

CONTENT

Abstract.....	A-3
General Purposed IO.....	A-4
Watchdog Timer.....	A-5
LVDS Backlight Brightness Control	A-6
SMBus Access.....	A-7

Abstract

In this document, code examples based on C programming language provided for customer interest. **Inportb**, **Outportb**, **Inportl** and **Outportl** are basic functions used for access IO ports and defined as following.

Inportb: Read a single 8-bit I/O port.

Outportb: Write a single byte to an 8-bit port.

Inportl: Reads a single 32-bit I/O port.

Outportl: Write a single long to a 32-bit port.

General Purposed IO

1. General Purposed IO – GPIO/DIO

The GPIO port configuration addresses listed in the following table:

Name	IO Port	IO address	Name	IO Port	IO address
N_GPIO0	0xA05	Bit 3	N_GPO0	0xA04	Bit 0
N_GPIO1	0xA05	Bit 4	N_GPO1	0xA04	Bit 1
N_GPIO2	0xA05	Bit 5	N_GPO2	0xA04	Bit 2
N_GPIO3	0xA05	Bit 6	N_GPO3	0xA04	Bit 3
N_GPIO4	0xA05	Bit 0	N_GPO4	0xA06	Bit 7
N_GPIO5	0xA05	Bit 7	N_GPO5	0xA04	Bit 4
N_GPIO6	0xA05	Bit 2	N_GPO6	0xA06	Bit 5
N_GPIO7	0xA05	Bit 1	N_GPO7	0xA06	Bit 6

1.1 Set output value of GPO

1. Read the value from GPO port.
2. Set the value of GPO address.
3. Write the value back to GPO port.

Example: Set N_GPO0 output “high”

```
val = Inportb (0xA04);           // Read value from N_GPO0 port.
val = val | (1<<0);             // Set N_GPO0 address (bit 0) to 1 (output “high”).
Outportb (0xA04, val);         // Write back to N_GPO0 port.
```

Example: Set N_GPO1 output “low”

```
val = Inportb (0xA04);           // Read value from N_GPO1 port.
val = val & ~(1<<1);            // Set N_GPO1 address (bit 1) to 0 (output “low”).
Outportb (0xA04, val);         // Write back to N_GPO1 port.
```

1.2 Read input value from GPI

1. Read the value from GPI port.
2. Get the value of GPI address.

Example: Get N_GPI2 input value.

```
val = Inportb (0xA05);           // Read value from N_GPI2 port.
val = val & (1<<5);             // Read N_GPI2 address (bit 5).
if (val)    printf (“Input of N_GPI2 is High”);
else       printf (“Input of N_GPI2 is Low”);
```

Watchdog Timer

2. Watchdog Timer – WDT

The base address (WDT_BASE) of WDT configuration registers is 0xA10.

2.1 Set WDT Time Unit

```
val = Inportb (WDT_BASE + 0x05); // Read current WDT setting
val = val | 0x08; // minute mode. val = val & 0xF7 if second mode
Outportb (WDT_BASE + 0x05, val); // Write back WDT setting
```

2.2 Set WDT Time

```
Outportb (WDT_BASE + 0x06, Time); // Write WDT time, value 1 to 255.
```

2.3 Enable WDT

```
val = Inportb (WDT_BASE + 0x0A); // Read current WDT_PME setting
val = val | 0x01; // Enable WDT OUT: WDOUT_EN (bit 0) set to 1.
Outportb (WDT_BASE + 0x0A, val); // Write back WDT setting.
val = Inportb (WDT_BASE + 0x05); // Read current WDT setting
val = val | 0x20; // Enable WDT by set WD_EN (bit 5) to 1.
Outportb (WDT_BASE + 0x05, val); // Write back WDT setting.
```

2.4 Disable WDT

```
val = Inportb (WDT_BASE + 0x05); // Read current WDT setting
val = val & 0xDF; // Disable WDT by set WD_EN (bit 5) to 0.
Outportb (WDT_BASE + 0x05, val); // Write back WDT setting.
```

2.5 Check WDT Reset Flag

If the system has been reset by WDT function, this flag will set to 1.

```
val = Inportb (WDT_BASE + 0x05); // Read current WDT setting.
val = val & 0x40; // Check WDTMOUT_STS (bit 6).
if (val) printf ("timeout event occurred");
else printf ("timeout event not occurred");
```

2.6 Clear WDT Reset Flag

```
val = Inportb (WDT_BASE + 0x05); // Read current WDT setting
val = val | 0x40; // Set 1 to WDTMOUT_STS (bit 6);
Outportb (WDT_BASE + 0x05, val); // Write back WDT setting
```

LVDS Backlight Brightness Control

3. LVDS Backlight Brightness Control

The LVDS controller support 17 level of backlight brightness value from 0 (30%) to 16 (100%) and it is accessible through SMBus. The associated access method (**SMBus_ReadByte**, **SMBus_WriteByte**) provided in part 4.

3.1 Set the Level of LVDS Backlight

1. Write **0xED** into address **0x7F** on SMBus device **0x42**.
2. Write desired backlight level from 0x0 (30%) to 0x10 (100%) into address **0x6E** on SMBus device **0x42**.

Example: Set LVDS backlight level to 0x10 (100%)

```
SMBus_WriteByte (0x42, 0x7F, 0xED);
```

```
SMBus_WriteByte (0x42, 0x6E, 0x10); // Set brightness to 100%
```

3.2 Read the Level of LVDS Backlight

1. Write **0xED** into address **0x7F** on SMBus device **0x42**.
2. Read current backlight level from address **0x6E** on SMBus device **0x42**.

Example: Get LVDS backlight level

```
SMBus_WriteByte (0x42, 0x7F, 0xED);
```

```
BKL_Value = SMBus_ReadByte (0x42, 0x6E);
```

SMBus Access

4. SMBus Access

The base address of SMBus must know before access. The relevant bus and device information are as following.

```
#define IO_SC          0xCF8
#define IO_DA          0xCFC
#define PCIBASEADDRESS 0x80000000
#define PCI_BUS_NUM    0
#define PCI_DEV_NUM    31
#define PCI_FUN_NUM    4
```

4.1 Get SMBus Base Address

```
int SMBUS_BASE;
int DATA_ADDR = PCIBASEADDRESS + (PCI_BUS_NUM<<16) +
                (PCI_DEV_NUM<<11) +
                (PCI_FUN_NUM<<8);
```

```
Outportl (DATA_ADDR + 0x20, IO_SC);
SMBUS_BASE = Inportl (IO_DA) & 0xfffffff0;
```

4.2 SMBus_ReadByte (char DEVID, char offset)

Read the value of OFFSET from SMBus device DEVID.

```
Outportb (LOWORD (SMBUS_BASE), 0xFE);
Outportb (LOWORD (SMBUS_BASE) + 0x04, DEVID + 1); //out Base + 04, (DEVID + 1)
Outportb (LOWORD (SMBUS_BASE) + 0x03, OFFSET); //out Base + 03, OFFSET
Outportb (LOWORD (SMBUS_BASE) + 0x02, 0x48); //out Base + 02, 48H
mdelay (20); //delay 20ms to let data ready
while ((Inportl (SMBUS_BASE) & 0x01) != 0); //wait SMBus ready
SMB_DATA = Inportb (LOWORD (SMBUS_BASE) + 0x05); //input Base + 05
```

4.3 SMBus_WriteByte (char DEVID, char offset, char DATA)

Write DATA to OFFSET on SMBus device DEVID.

```
Outportb (LOWORD (SMBUS_BASE), 0xFE);
Outportb (LOWORD (SMBUS_BASE) + 0x04, DEVID); //out Base + 04, (DEVID)
Outportb (LOWORD (SMBUS_BASE) + 0x03, OFFSET); //out Base + 03, OFFSET
Outportb (LOWORD (SMBUS_BASE) + 0x05, DATA); //out Base + 05, DATA
Outportb (LOWORD (SMBUS_BASE) + 0x02, 0x48); //out Base + 02, 48H
mdelay (20); //wait 20ms
```