

PM-311B

Quick Installation Guide



©2016 RuggON Corporation. All rights reserved.

Accessory

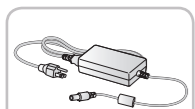

Power Adapter

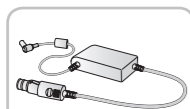

Car Adapter*



Stylus

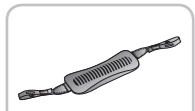

2-Point Carrying Handle

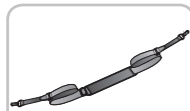

2-Point Shoulder Strap

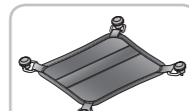

4-Point Handstrap



Extended Battery*



Battery Charger*



MSR with Barcode*

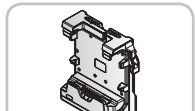

Vehicle Dock*

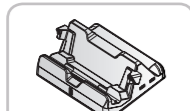

Desktop Dock*

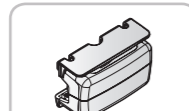

MSR with MRZ*

*Optional, not included in the standard package.

Overview

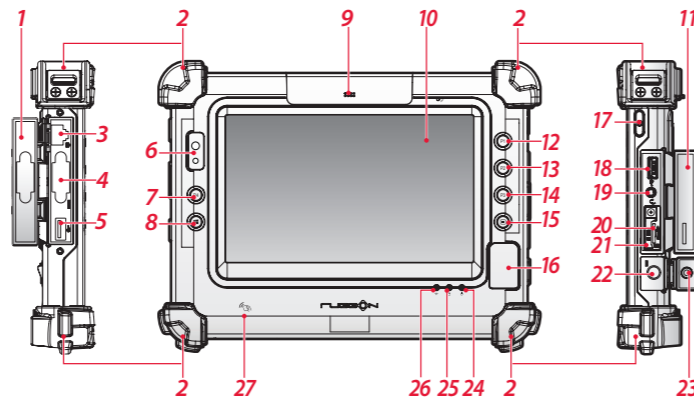

- | | |
|----------------------------------|-----------------------|
| 1 Left I/O compartment cover | 15 Menu button |
| 2 Rubber bumpers | 16 Fingerprint reader |
| 3 LAN | 17 Power button |
| 4 RS-232 | 18 USB 3.0 |
| 5 USB 3.0 | 19 Audio jack |
| 6 Front camera | 20 MicroSD slot |
| 7 P4 button | 21 Micro SIM slot |
| 8 Windows button | 22 DC-IN jack |
| 9 Snap-on module connector cover | 23 DC-IN cover |
| 10 Touch screen | 24 Power LED |
| 11 Right I/O compartment cover | 25 Storage access LED |
| 12 P1 button | 26 Wi-Fi LED |
| 13 P2 button | 27 NFC |
| 14 P3 button | |

SIM Card and SD Card

1. Flip the I/O cover open.

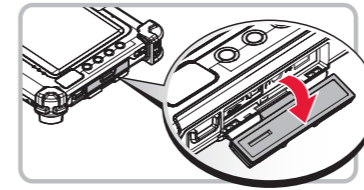

2. Remove the screw securing the SIM slot securing bracket.
3. Remove the securing bracket.

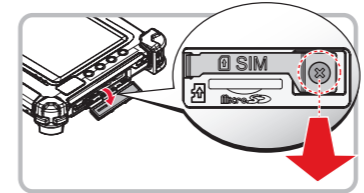

Note: Step 2 and 3 are only applicable when installing a SIM card.

4. The card has a corner missing. Align the card with the slot making sure that the corners match.
5. Insert the card and press it in until an audible click sounds.

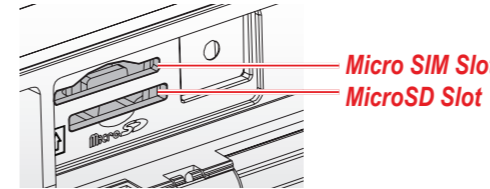

Strap

HandStrap

1. Place the D-rings over the upper and lower positions on the device.
2. Twist the D-rings (clockwise) to secure the handstrap.

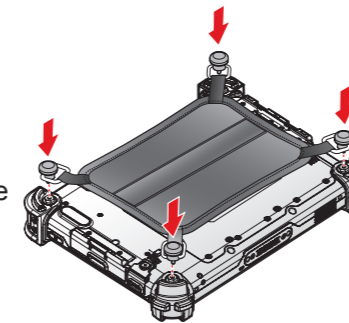

Carrying Handle and Shoulder Strap

1. The handle must be positioned so that the securing post and velcro side are facing outward.
2. Thread one end of the strap through the metal loop on the bumper.
3. Pull the strap end through the loop and insert the post through the slit on the strap.
4. Secure the strap by attaching the two velcro ends together.

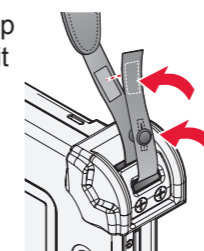
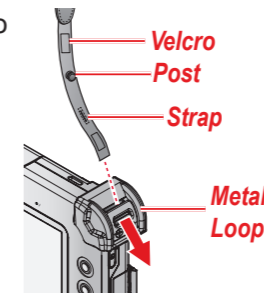

Charging

1. Flip open the DC-IN cover to expose the DC-IN jack.

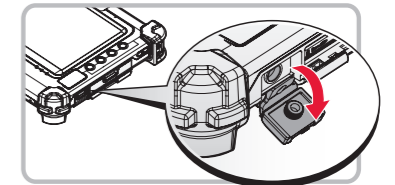

2. Connect the AC adapter to the DC-IN port.

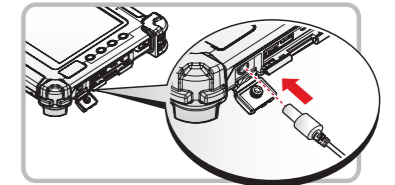

Note: Before first use, fully charge the battery.

Power On

1. Press and hold the power button for at least 1 second to power on the device.

