

www.janitza.com

Janitza electronics GmbH
 Vor dem Polstück 1
 D-35633 Lahnau
 Support tel. 0049 6441 9642-22
 Fax 0049 6441 9642-30
 E-mail: info@janitza.com
 Internet: http://www.janitza.com

Power Analyser

UMG 96 RM-E

Residual current monitoring (RCM)

Operating instructions and technical data

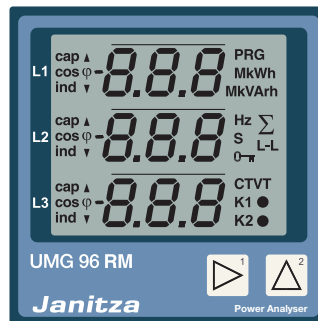

Janitza®

Content

General	4	Configuration	48
Inspection on receipt	6	Connecting the supply voltage	48
Scope of delivery – UMG 96RM-E (RCM)	7	Current and voltage transformers	48
Available accessories	7	Programming the	
Product description	8	current transformer for I1 to I3	50
Proper use	8	Programming the voltage transformer	51
Performance characteristics – UMG 96RM-E	10	Programming parameters	52
Measuring process	11	TCP/IP configuration	53
Operating concept	11	RS485 device address (Addr. 000)	56
GridVis network analysis software	11	RS485 baud rate (Addr. 001)	56
Connection variants	12	MODBUS gateway (Addr. 002)	57
Mounting	13	User password (Addr. 050)	57
Installation	15	Parameter	58
Power supply	15	Mean value	58
Measuring voltage	16	Averaging method	58
Current measurement via I1 to I4	22	Min. and max. values	58
Residual current measurement (RCM) via I5, I6	31	Mains frequency (Addr. 034)	59
Temperature measurement input	33	Energy meter	60
RS485 interface	34	Reset energy meter (Addr. 507)	60
Ethernet interface	37	Harmonics	61
Digital in-/outputs	38	Measured value rotation	62
LED status bar	43	Measured value indications	62
Operation	44	Phase sequence	64
Display mode	44	LCD contrast (Addr. 035)	64
Programming mode	44	Backlight	64
Parameters and measured values	46	Time recording	65

Operating hours meter	66	Error/warning messages	88
Serial number (Addr. 754)	66	Technical data	94
Recordings	67	Function parameters	102
Putting into service	68	Table 1 – Parameter list	104
Connecting the supply voltage	68	Table 2 - Modbus address list	108
Applying the measuring-circuit voltage	68	Number formats	111
Applying the measuring-circuit voltage	68	Dimension diagrams	112
Phase sequence	69	Measured value displays overview	114
Check phase assignment	69	Declaration of conformity	120
Checking the energy measurement	69	Connection example 1	121
Applying the residual current	69	Connection example 2	122
Failure monitoring (RCM) for I5, I6	70	Basic functions quick guide	123
Checking the measurement	72	TCP/IP addressing quick guide	124
Checking the individual outputs	72		
Checking the total power outputs	72		
RS485 interface	74		
Digital outputs	76		
Impulse output	78		
Service and maintenance	84		
Service	84		
Device calibration	84		
Calibration intervals	84		
Firmware update	85		
Battery	85		
Battery monitoring function	86		
Replacing the battery	87		

General

Copyright

This operating manual is subject to the legal requirements for copyright protection and may not be, either in whole or in part, photocopied, reprinted, or reproduced by mechanical or electronic means, or in any other manner be duplicated or redistributed without the legally binding, written agreement of

Janitza electronics GmbH, Vor dem Polstück 1,
D 35633 Lahnu, Germany.

Trademarks

All trademarks and their resulting rights belong to the respective holders of these rights.

Disclaimer

Janitza electronics GmbH takes no responsibility for errors or defects within this operating manual and takes no responsibility for keeping the contents of this operating manual up to date.

Comments on the operating manual

We welcome your comments. In the event that anything in this operating manual seems unclear, please let us know and send us an EMAIL to: info@janitza.de

Meaning of the symbols

The following pictograms are used in the operating manual at hand:



Dangerous voltage!

Danger to life or risk of serious injury. Disconnect system and device from power supply before beginning work.



Caution!

Please follow the documentation. This symbol warns of possible dangers that can arise during installation, commissioning and use.



Note!

Instructions for use

Please read the operating manual at hand as well as all other publications that must be drawn from for working with this product (in particular for the installation, operation or maintenance).

Follow all safety regulations and warning information. If you do not follow the information, it can result in bodily injury and/or damage to the product.

Any unauthorized changes or use of this device, which transcend the mechanical, electrical or otherwise stated operating limitations, can result in bodily injury or/and damage to the product.

Any of such unauthorized changes constitute "misuse" and/or "negligence" in terms of the warranty for the product and therefore eliminates the warranty for covering any potential damage resulting from this.

This device is to be operated and maintained exclusively by specialized personnel.

Specialized personnel are persons, that based on their respective training and experience, are qualified to recognize risks and prevent potential dangers that can be caused by the operation or maintenance of the device.

Additional legal and safety regulations required for the respective application are to be following during the use of the device.



If the device is not operated according to the operating manual, protection is no longer ensured and danger can come from the device.



Conductors made from single wires must be fitted with wire-end ferrules.



Only pluggable screw terminals with the same number of poles and the same type of construction are permitted to be connected together.

Concerning these operating instructions

These operating instructions are a part of the product.

- Read the operating instructions before using the device.
- Keep the operating instructions throughout the entire service life of the product and have them readily available for reference.
- Pass the operating instructions on to each subsequent owner or user of the product.



All screw-type terminals included in delivery are attached to the device.

Inspection on receipt

The prerequisites of faultless, safe operation of this device are proper transport and proper storage, set-up and assembly, as well as careful operation and maintenance. If it can be assumed that risk-free operation is no longer possible, the unit must be immediately put out of operation and secured against being put back into operation again.

The packing and unpacking must be carried out with the customary care without the use of force and only using suitable tools. The devices should be visually checked for flawless mechanical condition.

It can be assumed that risk-free operation is no longer possible if the device, for example,

- has visible damage
- no longer works despite the mains power supply being intact
- has been exposed to long-term adverse conditions (e.g. storage outside the permissible climate limits without being adapted to the room climate, condensation etc.) or rough handling during transportation (e.g. fall from a height, even if there is no visible external damage etc.)
- Please check the delivered items for completeness before you start installing the device.

Scope of delivery – UMG 96RM-E (RCM)

Number	Part no.	Description
1	52.22.036	UMG 96RM-E
2	52.22.251	Mounting clips.
1	33.03.158	Operating instructions.
1	51.00.116	CD with following content. - GridVis programming software - GridVis functional description
1	10.01.855	Screw-type terminal, pluggable, 2-pole (auxiliary power)
1	10.01.849	Screw-type terminal, pluggable, 4-pole (voltage measurement)
1	10.01.871	Screw-type terminal, pluggable, 6-pole (current measurement I1-I3)
1	10.01.875	Screw-type terminal, pluggable, 2-pole (current measurement I4)
1	10.01.865	Screw-type terminal, pluggable, 10-pole (digital/analogue inputs/outputs)
1	10.01.857	Screw-type terminal, pluggable, 2-pole (RS 485)
1	10.01.859	Screw-type terminal, pluggable, 3-pole (Digital/impulse output)
1	08.01.505	Patch cable 2m, coiled, grey (connection UMG 96RM-PC/Switch)
1	52.00.008	RS485, external terminating resistor, 120 ohm

Available accessories

Part no.	Description
21.01.058	Lithium battery CR2032, 3V (approval i.a.w. UL 1642)
29.01.907	Seal, 96 x 96
15.06.015	Interface converter RS485 <-> RS232
15.06.025	Interface converter RS485 <-> USB

Product description

Proper use

The UMG 96RM-E is intended for the measurement and calculation of electrical parameters such as voltage, current, power, energy, harmonics etc. in building installations, on distribution units, circuit breakers and busbar trunking systems.

The UMG 96RM-E is suitable for integration into fixed and weatherproof switch panels. Conductive switch panels must be earthed.

Measured voltage and measured current must derive from the same network.

The measurement results can be displayed and can be read out and further processed via the RS485 interface.

The voltage measurement inputs are designed for measurements in low voltage networks, in which rated voltages of up to 300V relative to earth and surges in overvoltage category III can occur.

The current measurement inputs I1–I4 of the UMG 96RM-E are connected via external $\dots/1A$ or $\dots/5A$ current transformers.

By continuously monitoring the residual currents (RCM) of an electrical system via the inputs I5 and I6, warning pulses can be triggered if a response threshold is exceeded. Using these, the system operator can be alarmed before a protective equipment reacts. The UMG 96RM-E does not provide protection against and electric shock!

The residual current measuring is done via the current measurement inputs I5 and I6 via an external residual current transformer with a rated current of 30 mA.

Measurements in medium and high-voltage networks is always done via current and voltage transformers.



The residual current measuring monitors residual currents via external current transformers and can trigger a warning impulse when a response threshold is exceeded. Thus, the device is **NOT** an independent protective device!

The UMG 96RM-E can be used in industrial and domestic settings.

Device characteristics

- Supply voltage:
20V - 250V (45..65Hz) or DC 20V - 300V
- Frequency range: 45-65Hz

Device functions

- 3 voltage measurements, 300V
- 4 current measurements
(via current transformers ../5A or ../1A)
- 2 residual current measurements
(via residual current transformers ../30mA) or
optionally 2 temperature measurements
- RS485 interface, Ethernet
- 2 digital outputs and additional 3 digital
inputs/outputs
- Clock and memory function

Performance characteristics – UMG 96RM-E

General

- Front panel integration device with dimensions 96x96 mm.
- Connection via pluggable screw terminals
- LCD display with backlighting
- Operation via 2 buttons
- 3 voltage and 4 current measurement inputs
- Optional 2 residual current or temperature measurement inputs
- 2 digital outputs and 3 digital inputs/outputs
- RS485 interface (Modbus RTU, slave, up to 115 kbps)
- Ethernet (web server)
- 256 MB flash memory (200 MB available for records)
- Clock and battery (with battery monitoring function)
- Working temperature range -10°C .. +55°C

Uncertainty in measurement

- Active energy uncertainty in measurement class 0.5 for ../5A transformer
- Active energy uncertainty in measurement class 1 for ../1A transformer
- Reactive energy, class 2

Measurement

- Measurement in IT, TN and TT networks
- Measurement in networks with nominal voltage up to L-L 480V and L-N 277V
- Measuring range current 0 to 5A eff.
- True RMS (TRMS)
- Continuous sampling of the voltage and current measurement inputs
- Continuous monitoring of residual currents with failure monitoring
- Temperature measurement
- Frequency range of the fundamental oscillation 45Hz .. 65Hz
- Measurements of the harmonic components 1st to 40th for ULN and I
- Uln, I, P (reference/del.), Q (ind./cap.)
- Collection of well over 1000 measured values
- Fourier analyses 1st to 40th harmonic component for U and I
- 7 energy counters for active energy (reference), active energy (supply), active energy (without return barrier), reactive energy (ind.), reactive energy (cap.), reactive energy (without return barrier), apparent energy, each for L1, L2, L3 and total

Measuring process

The UMG 96RM-E measures continuously and calculates all effective values over a 10/12 period interval. The UMG 96RM-E measures the real effective value (TRMS) of the voltage and current connected to the measurement inputs.

Operating concept

You can program and call up the measured values via many routes using the UMG 96RM-E.

- Directly on the device via 2 buttons.
- Using the GridVis programming software.
- Through the device's home page.
- Using the Modbus protocol.

You can modify and call up the data using the Modbus address list. The list can be called up via the device's home page and can be found on the enclosed CD.

This manual only describes how to operate the UMG 96RM-E using the two buttons.

The GridVis programming software has its own online help system.

GridVis network analysis software

The UMG 96RM-E can be programmed and read out using the GridVis network analysis software included in the scope of deliverables. For this a PC must be connected to the UMG 96RM-E via a serial interface (RS485) or via Ethernet.

GridVis features

- Programming the UMG 96RM-E
- Graphical representation of measured values

Connection variants

Connection of a UMG 96RM-E to a PC via a interface converter:

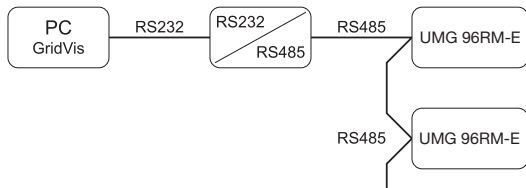

Direct connection of a UMG 96RM-E to a PC via Ethernet.



Connection of a UMG 96RM via a UMG 96RM-E as a gateway.

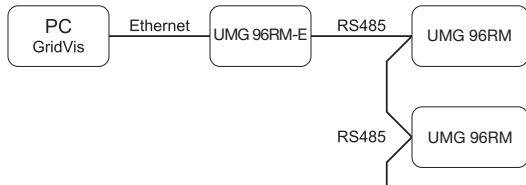

Connecting a UMG 96RM-E to a PC via Ethernet.

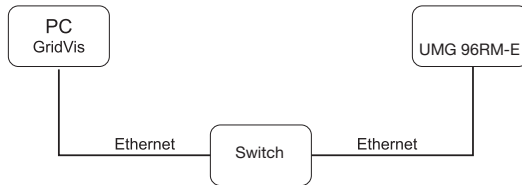

Mounting

Position of installation

The UMG 96RM-E is suitable for integration into fixed and weatherproof switch panels. Conductive switch panels must be earthed.

Mounting position

To ensure adequate ventilation, the UMG 96RM-E must be installed vertically. There should be separation above and below of at least 50mm with 20mm space to the sides.

Front panel section

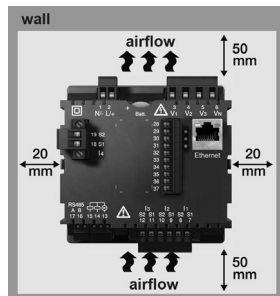

Cut-out size:
 $92^{+0.8} \times 92^{+0.8}$ mm.

*Fig. mounting position
 UMG 96RM-E
 (View from rear)*



Failure to meet the minimum clearances can destroy the UMG 96RM-E at high ambient temperatures!

Mounting

The UMG 96RM-E is fixed using the mounting clips found on the side of the switch panel. Before inserting the device, they should be moved out of the way in a horizontal lever using a screwdriver, for example.

Fig. side view UMG 96RM-E with mounting clips. Loosening the clips is done using a screwdriver and a horizontal lever effect.

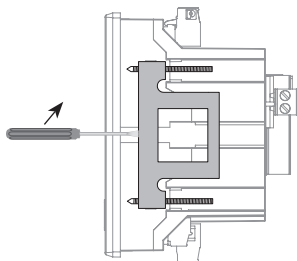

The fastening is then done when the device is pushed in an the clamps lock in place when the screws are tightened.

- Please tight the fixing screws until they contact the mounting plate easily.
- Tighten with two further turns, the clamping screws (are the screws tightened too much, the mounting bracket will be destroyed)

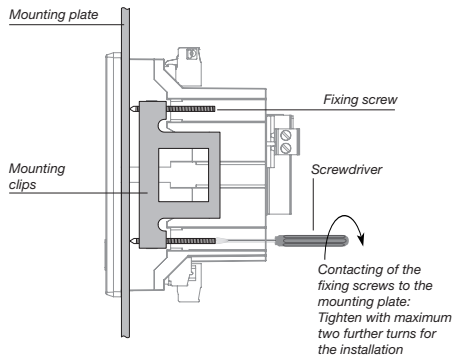

Installation

Power supply

The 96RM-E needs a supply voltage to operate. The supply voltage is connected on the rear of the device via terminal blocks.

Before connecting the supply voltage, ensure that the voltage and frequency correspond to the details on the ratings plate!

The supply voltage must be connected through a UL/IEC approved fuse (6A, type C).



- If installed in a building, a disconnector or circuit-breaker must be provided for the supply voltage.
- The disconnector must be installed near the device and easily accessible to the user.
- The switch must be marked as the circuit breaker for this device.
- Voltages which are over the permitted voltage range can destroy the device.

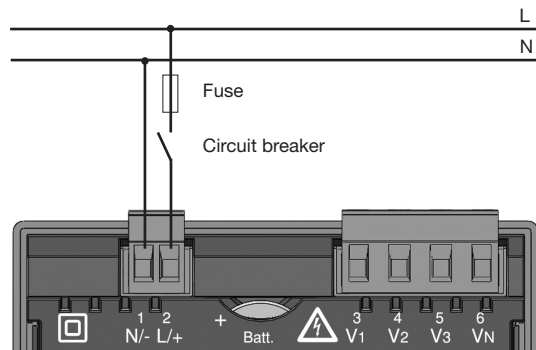

Fig. connection example of the supply voltage to a UMG 96RM

Measuring voltage

You can use the UMG 96RM-E to measure voltage in TN-, TT-, and IT systems.

The voltage measurement in the UMG 96RM-E is designed for the overvoltage category 300V CAT III (rated impulse voltage 4 kV).

In systems without N, the measurements which require an N are to a calculated N.

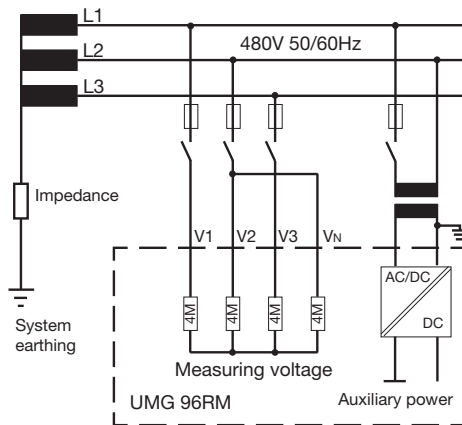
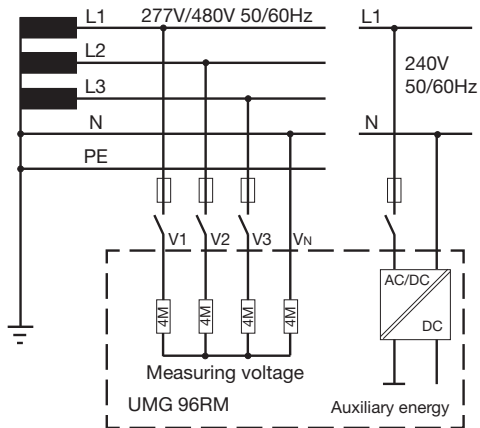

Fig. schematic diagram - measurements in three-phase 4-wire systems.

Fig. schematic diagram - measurements in three-phase 3-wire systems.

Network nominal voltage

Lists of networks and their nominal network voltages in which the UMG 96RM-E can be used.

Three-phase, 4-wire systems with earthed neutral conductor.

U_{L-N} / U_{L-L}
66V / 115V
120V / 208V
127V / 220V
220V / 380V
230V / 400V
240V / 415V
260V / 440V
277V / 480V

Maximum system nominal voltage

Fig. table for network nominal voltages i.a.w. EN60664-1:2003 suitable for the voltage measurement inputs.

Three-phase, 3-wire systems, unearthed.

U_{L-L}
66V
120V
127V
220V
230V
240V
260V
277V
347V
380V
400V
415V
440V
480V

Maximum system nominal voltage

Fig. table for network nominal voltages i.a.w. EN60664-1:2003 suitable for the voltage measurement inputs.

Voltage measurement inputs

The UMG 96RM-E has three voltage measurement inputs (V1, V2, V3).

Surge voltage

The voltage measurement inputs are suitable for use in networks where overvoltages of overvoltage category 300V CATIII (rated impulse voltage 4kV) can occur.

Frequency

For the measurement and calculation of measured values, the UMG 96RM-E needs the network frequency. The UMG 96RM-E is suitable for measurements on systems in a frequency range from 45 to 65Hz.

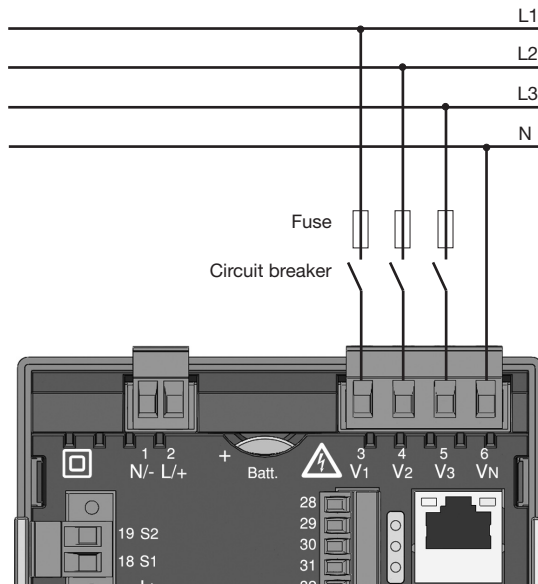

Fig. Example connection for measuring voltage

When connecting the voltage to be measured, the following must be observed:

- A suitable isolation device must be fitted to disconnect and de-energise the UMG 96RM-E.
- The isolation device must be placed in the vicinity of the UMG 96RM-E, be marked for the user and easily accessible.
- Use a UL/IEC approved circuit breaker 10A (Type C) for the over-current protection and isolation device.
- The over-current protection must have a rated value which is suitable for the short circuit current at the connection point.
- Measured voltage and measured current must derive from the same network.

**Caution!**

Voltages which exceed the permitted network rated voltage must be connected via a voltage transformer.

**Caution!**

The UMG 96RM-E is not suitable for measuring DC voltages.

**Caution!**

The voltage measurement inputs on the UMG 96RM-E are dangerous if touched!

Wiring diagrams, voltage measurement

- 3p 4w (Addr. 509= 0), factory setting

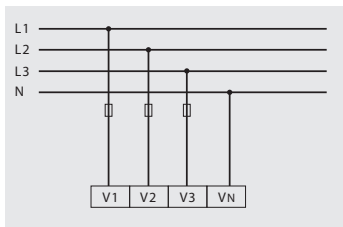

Fig. System with three line conductors and neutral conductor.

- 3p 4u (Addr. 509 = 2)

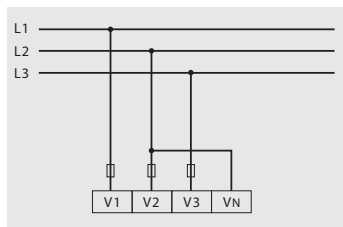

Fig. System with three line conductors without neutral conductor. Measurements which require a N are based on a calculated N.

- 3p 4wu (Addr. 509 = 1)

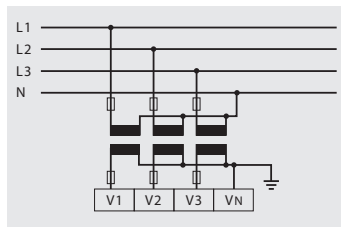

Fig. System with three line conductors and neutral conductor. Measurement using a voltage transformer.

- 3p 2u (Addr. 509 = 5)

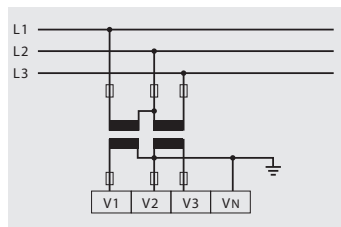

Fig. System with three line conductors without neutral conductor. Measurement using a voltage transformer. Measurements which require a N are based on a calculated N.

- 1p 2w1 (Addr. 509 = 4)

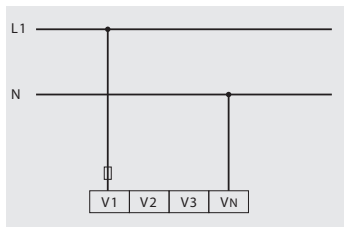

Fig. The values obtained from the voltage measurement inputs V2 and V3 are taken to be null and not calculated.

- 1p 2w (Addr. 509 = 6)

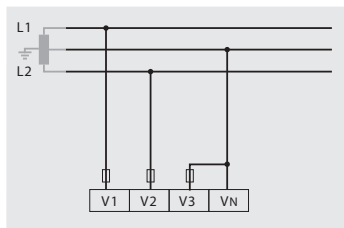

Fig. TN-C system with single-phase three-wire connection. The null is taken from the voltage measurement input V3's measured value and not calculated.

- 2p 4w (Addr. 509 = 3)

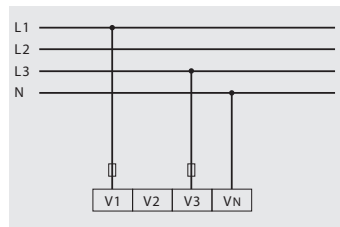

Fig. System with uniform phase loading. The measured values for the voltage measurement input V2 are calculated.

- 3p 1w (Addr. 509 = 7)

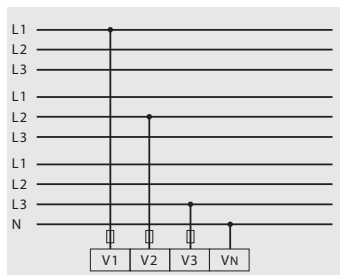

Fig. 3 systems with uniform phase loading. The not connected measured values L2/L3, L1/L3, and L1/L2 of each system are calculated.

Current measurement via I1 to I4

The UMG 96 RM-E is designed to have current transformers with secondary currents from $\dots/1A$ and $\dots/5A$ attached via terminals I1-I4. The factory default for the current transformer ratio is 5/5A and must be adapted to the current transformer employed if necessary.

Direct measurement without a current transformer is not possible using the UMG 96RM-E.

Only AC currents can be measured - DC currents cannot.

Via the **current measurement input I4** only an apparent current measurement is carried out thanks to the lack of a multiplier. Power measurements are therefore not possible using the I4 input.

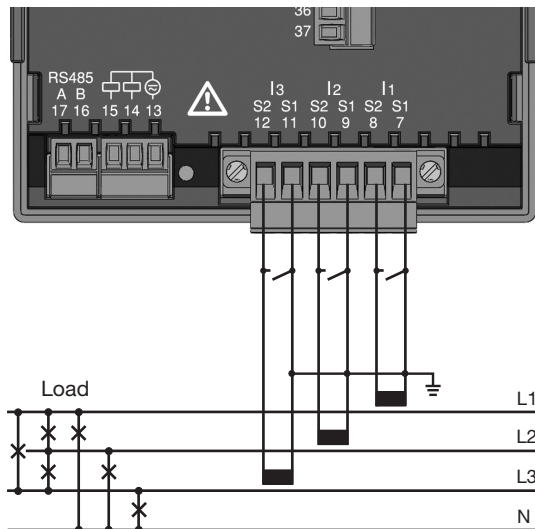

Fig. Current measurement (I1-I3) via current transformers (connection example)



Caution!

The current measurement inputs are dangerous to touch.



The attached screw terminal has to be fixed sufficiently with two screws on the device!



Earthing of current transformers!

If a connection is provided for the earthing of secondary windings then this must be connected to the earth.



Caution!

The UMG 96RM-E is not suitable for measuring DC voltages.



It is not necessary to configure a connection schematic for the I4 measurement input.

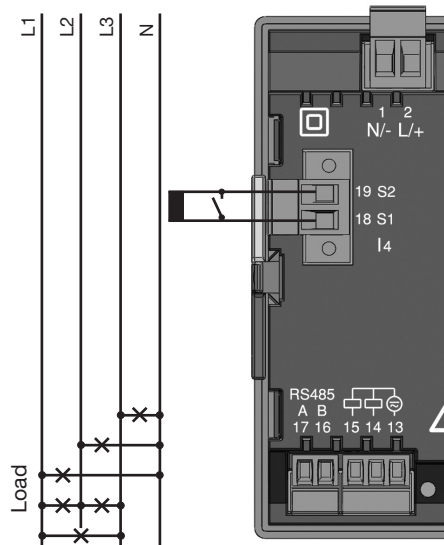

Fig. Current measurement (I4) via current transformer (connection example)

Current direction

The current direction can be individually corrected via the existing serial interface or on the device for each phase.

If incorrectly connected, a subsequent re-connection of the current transformer is not required.

When residual current measurements (RCM) are being carried out, there is no direction sensitive difference in the residual currents on the network or load side (not directionally sensitive).



Caution!

A residual current measurement is done using the terminals I5 and I6 (see page 30). There is **no** directional sensitivity of the residual currents on the network or load sides (not directionally sensitive).



Earthing of current transformers!

If a connection is provided for the earthing of secondary windings then this must be connected to the earth.



Current transformer connections!

The secondary connection of the current transformer must be short-circuited on this before the current feed to the UMG 96RM-E is disconnected!

If a test switch, which automatically short-circuits the secondary wires of the current transformer, is available then it is sufficient to set this to the "Test" position insofar as the short-circuiting device has been checked beforehand.



Open-circuit current transformers!

High voltage spikes that are dangerous to touch can occur on current transformers that are driven with open-circuit secondary windings!

With "safe open-circuit current transformers" the winding insulation is rated such that the current transformer can be driven open. However, even these current transformers are dangerous to touch when they are driven open-circuit.

**Caution!**

The UMG96RM is only approved for a current measurement using the current transformer.

Wiring diagrams, current measurement (I1-I3)

- 3p 4w (Addr. 510=0), factory setting

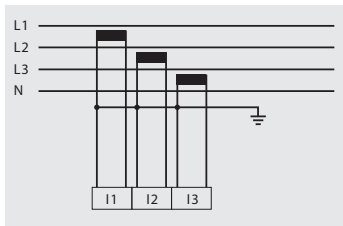

Fig. Measurement in a three-phase network with non-uniform load.

- 3p 2i (Addr. 510 = 1)

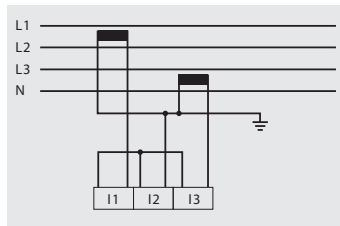

Fig. System with uniform phase loading. The measured values for the current measurement input I2 are measured.

- 3p 2i0 (Addr. 510 = 2)

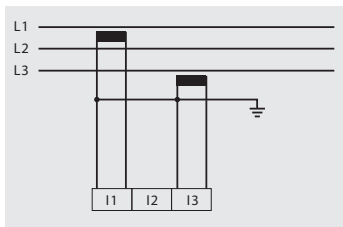

Fig. The measured values for the current measurement input I2 are calculated.

- 3p 3w3 (Addr. 510 = 3)

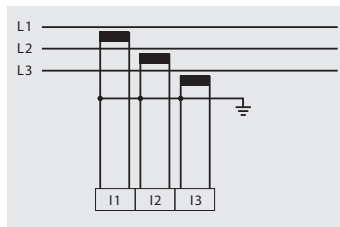

Fig. Measurement in a three-phase network with non-uniform load.

- 3p 3w (Addr. 510 = 4)

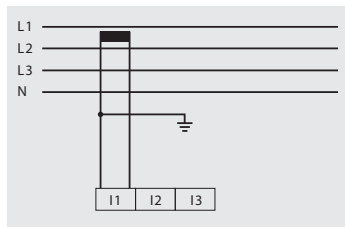

Fig. System with uniform phase loading. The measured values for the current measurement inputs I2 and I3 are calculated.

- 2p 4w (Addr. 510 = 5)

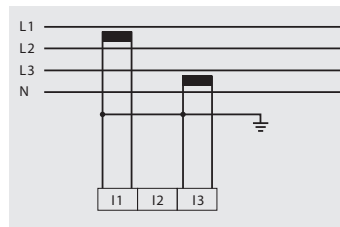

Fig. System with uniform phase loading. The measured values for the current measurement input I2 are calculated.

- 1p 2i (Addr. 510 = 6)

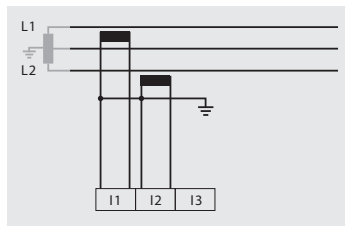

Fig. The null is taken from the current measurement input I3's measured value and not calculated.

- 1p 2w (Addr. 510 = 7)

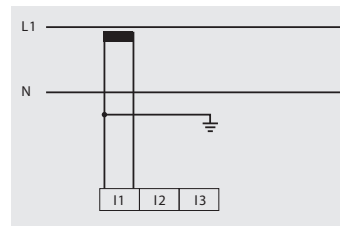

Fig. The null is taken from the current measurement inputs I2 and I3 measured values and not calculated.

Wiring diagrams, current measurement (I1-I3)

- 3p 1w (Addr. 510 = 8)

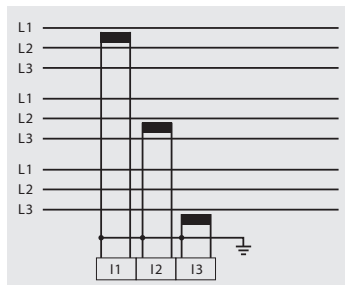

Fig. 3 systems with uniform phase loading. The not connected measured values $I2/I3$, $I1/I3$ and $I1/I2$ of the respective systems are calculated.

Ammeter

If you wish to measure the current not just using the UMG 96RM, rather also with a ammeter, the ammeter must be connected to the UMG 96RM-E in series.

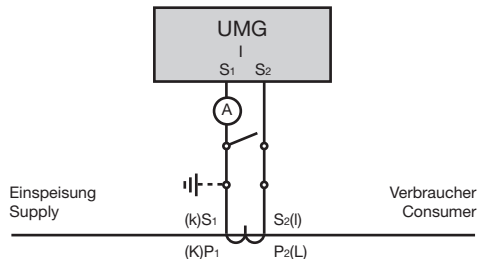

Fig. Current measurement with an additional ammeter (example).

Total current measurement

If the current measurement is done via two current transformers, the overall transformation ratio of the current transformers must be programmed into the UMG 96RM-E.

Example: The current is measured via two current transformers. Both current transformers have a transformation ratio of 1000/5A. The total measurement is done using a total current transformer 5+5/5A.

The UMG 96RM-E must then be setup as follows:

Primary current: $1000\text{A} + 1000\text{A} = 2000\text{A}$

Secondary current: 5A

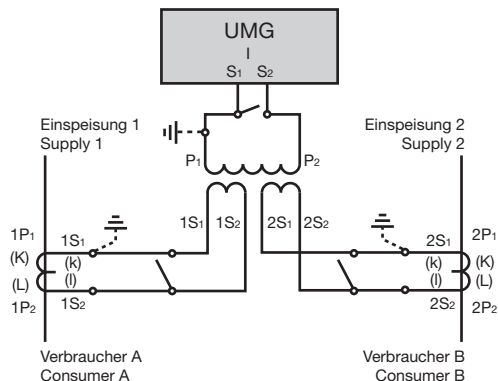

Fig. Current measurement using a total current transformer (example).

Analog inputs

The UMG 96RM-E has 2 analog inputs which can be used for one residual current measurement or one temperature measurement. The measurement is done using terminals 32-34 (input 1) or 35-37 (input 2).

The analog inputs can be used for residual current or temperature measurement in accordance with the following table:

Measurement	Terminal
Temperature	32/34 (input 1) and 35/37 (input 2)
Residual current	32/33/34 (input 1) and 35/36/37 (input 2)



Attention!

Operating equipment connected to the analogue inputs must exhibit reinforced or double insulation from mains supply circuits!

Example - temperature sensor:

A temperature sensor in close proximity to **non**-isolated mains cables should measure within a 300V CAT III network.

Remedy:

The temperature sensor must be equipped with reinforced or double insulation for 300V CAT III. This equates to a test voltage for the temperature sensor of 3000V AC (duration 1 min.).

Example - residual current transformer:

A residual current transformer should measure on isolated mains cables within a 300V CAT III network.

Remedy:

The insulation of the mains cables and the insulation of the residual current transformer must fulfil the basic insulation requirements for 300V CAT III. This equates to a test voltage of 1500V AC (duration 1 min.) for the insulated mains cables and a test voltage of 1500 V AC (duration 1 min.) for the residual current transformer.

Residual current measurement (RCM) via I5, I6

The UMG 96RM-E is for use as a residual current monitoring device (RCM), suitable for monitoring AC, pulsing DC, and DC.

The UMG 96RM-E can measure residual currents in accordance with IEC/TR 60755 (2008-01)

 of type A and

 type B.

The connection from suitable external residual current transformers with a rated current of 30 mA is done via the residual current transformer inputs I5 (terminals 33/34) and I6 (terminals 36/37).



Residual current transformer ratio

The GridVis software included with delivery can be used to individually program the residual current transformer inputs' transformer ratios.

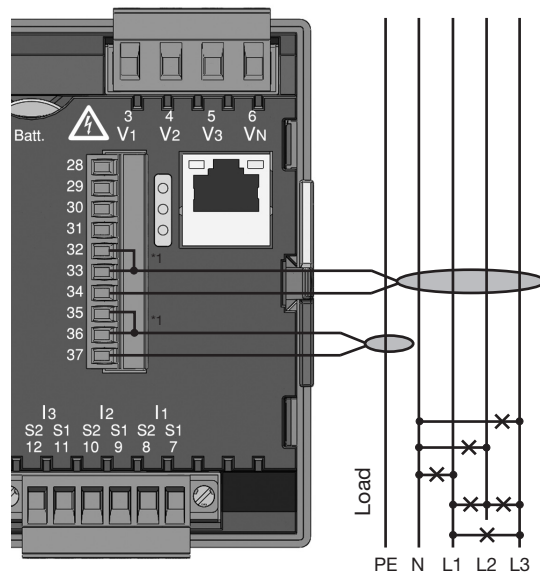

Fig. Connection example residual current measurement via current transformers

*1 Please note: Jumpers between connectors 32-33 respectively 35-36 are only required from hardware-release 104!

Connection example, residual current monitoring

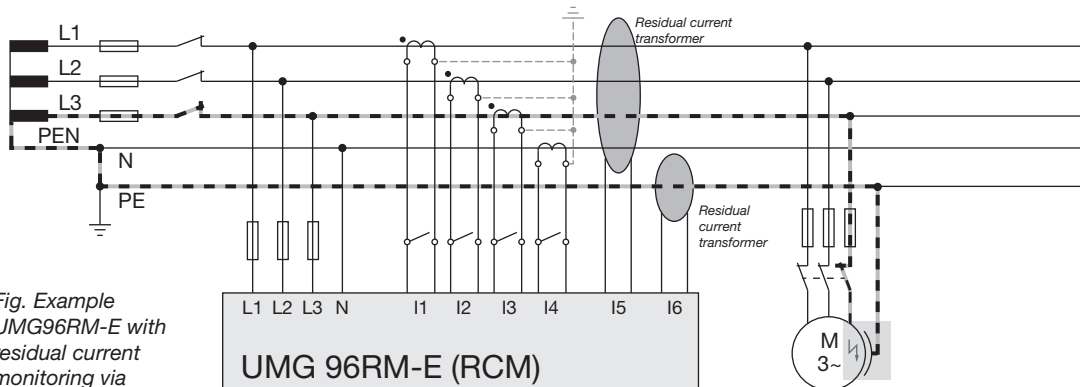

Fig. Example UMG96RM-E with residual current monitoring via measuring inputs i5/i6.



It is not necessary to configure a connection schematic for residual current inputs I5 and I6.

Temperature measurement input

The UMG 96RM-E has two temperature measuring inputs. The temperature is measured via terminals 32/34 (input 1) and 35/37 (input 2).

Do not exceed the total resistance load (sensor + cable) of 4kOhm.

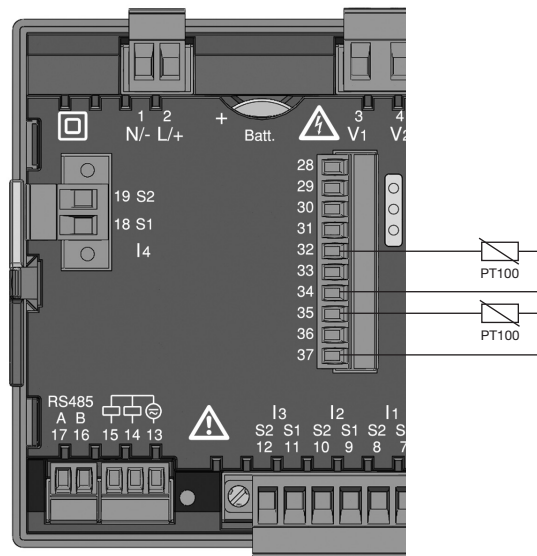

Fig. Example, temperature measurement with a Pt100



Use a shielded cable to connect the temperature sensor.

RS485 interface

In UMG 96RM-E, the RS485 interface is designed as a 2 pin plug contact, which communicates via the Modbus RTU protocol (also see Parameter programming).

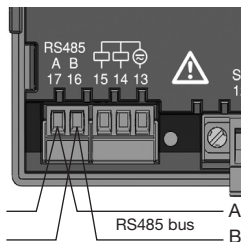

RS485 interface,
2-pole plug contact

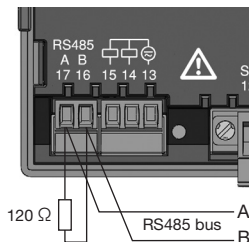

RS485 interface,
2-pole plug contact
with terminating resistor
(Item no. 52.00.008)

Termination resistors

The cable is terminated with resistors (120Ohm, 1/4W) at the beginning and at the end of a segment.

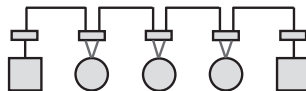

The UMG 96RM-E does not contain any termination resistors.

Correct

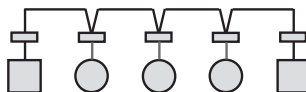

Incorrect



-  Terminal strip in the cabinet.
-  Device with RS485 interface.
(without terminating resistor)
-  Device with RS485 interface.
(with terminating resistor on the device)

Screening

Twisted screened cable should be used for connections via the RS485 interface.

- Earth the screens of all cables that lead to the cabinet, upon entering the cabinet.
- Connect the screens over a generous area and in a manner that will conduct well, to a low-noise earth.
- Gather the cables mechanically above the earthing clamp in order to avoid damage due to cable movements.
- Use suitable cable glands to feed the cables into the cabinet - for example armoured conduit couplings.



For the wiring of the Modbus connection, CAT cables are not suitable. Please use the recommended cables.

Cable type

The cable used must be suitable for an environmental temperature of at least 80°C.

Recommended cable types:

Unitronic Li2YCY(TP) 2x2x0.22 (from Lapp Kabel)

Unitronic BUS L2/FIP 1x2x0.64 (from Lapp Kabel)

Maximum cable length

1200m at a baud rate of 38.4k.

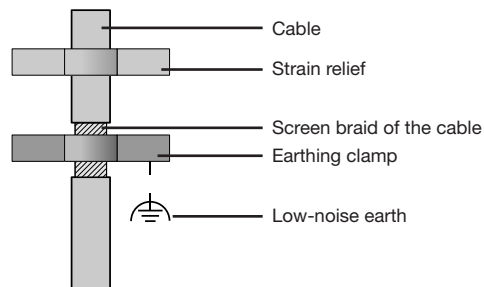

Fig. Screening procedure at cabinet entry.

Bus structure

- All devices are connected in a bus structure (line) and each device has its own address within the bus (see also Parameter programming).
- Up to 32 subscribers can be connected together in a single segment.
- The cable is terminated with resistors (bus termination 120Ohm, 1/4W) at the beginning and at the end of a segment.
- With more than 32 subscribers, repeaters (amplifiers) must be used to connect the individual segments.
- Devices for which the bus connection is switched on must be under current.
- It is recommended that the master be placed at the end of a segment.
- If the master is replaced with a bus connection, the bus must be switched off.
- Replacing a slave with a bus connection that is either switched on or de-energised can destabilise the bus.
- Devices that are not connected to the bus can be replaced without destabilising the bus.

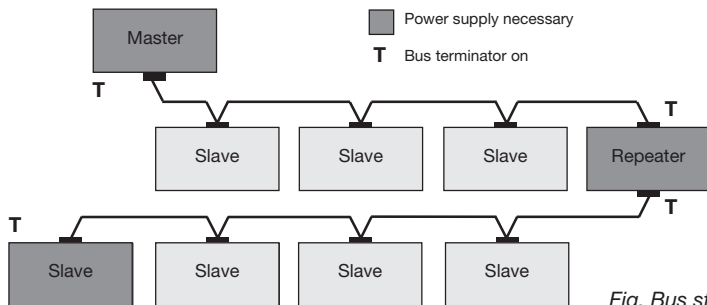
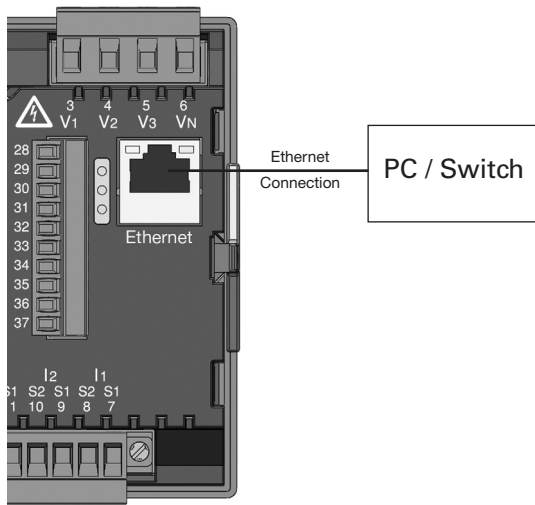

Fig. Bus structure

Ethernet interface

The Ethernet network settings should be specified by the network administrator and set on UMG 96RM-E accordingly.

If the network settings are not known, the UMG 96RM-E may not be integrated into the network through the patch cable.



Caution!

Connection of the UMG96RM-E to the Ethernet may only be carried out after discussion with the network administrator!



Caution!

The UMG 96RM-E is factory-programmed for the dynamic allocation of the IP settings (**DHCP mode**).

Settings can be changed as described in TCP/IP Configuration or, for example, via an appropriate Ethernet connection by means of GridVis software.

Digital in-/outputs

The UMG 96RM-E has 2 digital outputs and 3 optional digital inputs or outputs, which are divided into two groups (see figure). This means that only **entire** group 2 (connection 28 to 31) operate either as input or output; a different allocation within the group is not possible!

Digital outputs, Group 1

- The status indicator appears on the display at K1 or K2
- The status indicator on the display is not dependent on an inversion being activated (NC / NO)

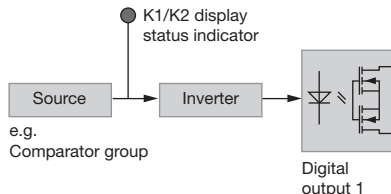

Digital outputs, Group 2

- The status of the inputs and outputs in Group 2 is indicated by the associated LED (cf. chapter LED status bar).

Digital outputs

These outputs are galvanically separated from the analysis electronics using optocouplers. The digital outputs have a joint reference.

- The digital outputs can switch AC and DC loads.
- The digital outputs are **not** short-circuit proof.
- Connected cables that are longer than 30m must be shielded when laid.
- An external auxiliary voltage is required.
- The digital outputs can be used as impulse outputs.
- The digital outputs can be controlled via Modbus.
- The digital outputs can display the results of comparators.

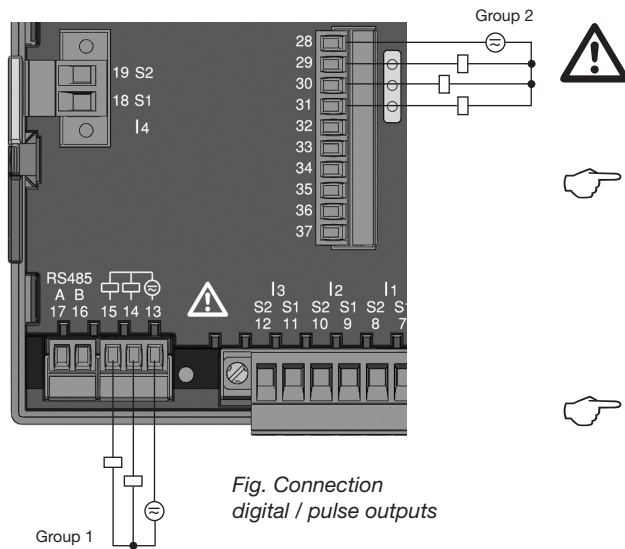

*Fig. Connection
digital / pulse outputs*

Caution!

Digital outputs are not short-circuit proof.

Functions for the digital outputs can be adjusted clearly in the GridVis software provided in the scope of deliverables. A connection between the UMG 96RM-E and the PC via an interface is required for the use of the GridVis software.

When using the digital outputs as pulse outputs the auxiliary voltage (DC) must have a max. residual ripple of 5%.

DC connection example

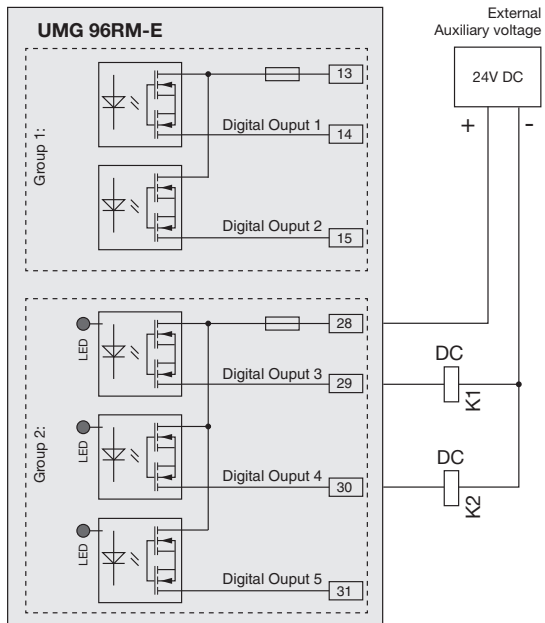

Fig. Example for two relays connected to the digital outputs

Digital inputs

When allocating Group 2 as inputs, the UMG96 RM-E has three digital inputs to each of which you can connect one signal transducer. When a signal is present, the corresponding LED lights up green.

An input signal is detected on a digital input if a voltage of at least 10V and maximum 28V is applied and where a current of at least 1mA and maximum 6mA flows at the same time. Wiring longer than 30m must be screened.

Note the correct polarity of the supply voltage!

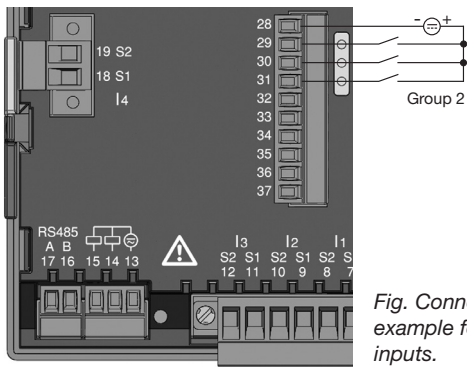

Fig. Connection example for digital inputs.

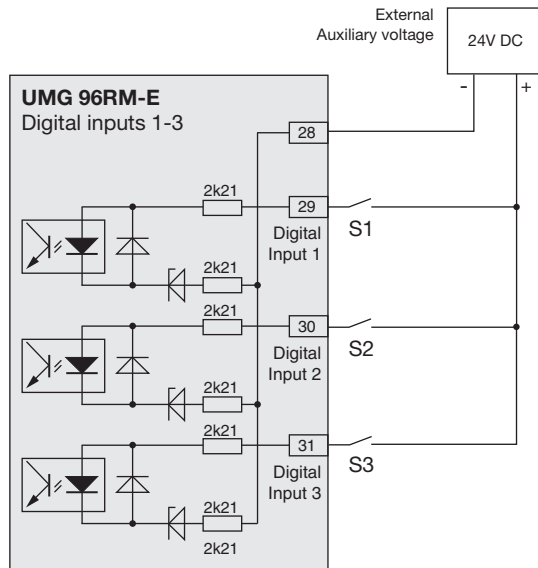

Fig. Example for the connection of external switch contacts S1 and S2 to digital inputs 1 and 2.

S0 pulse input

You can connect an S0 pulse transducer per DIN EN62053-31 to any digital input.

This requires an auxiliary voltage with an output voltage in the range 20 .. 28V DC and a resistor of 1.5kOhm.

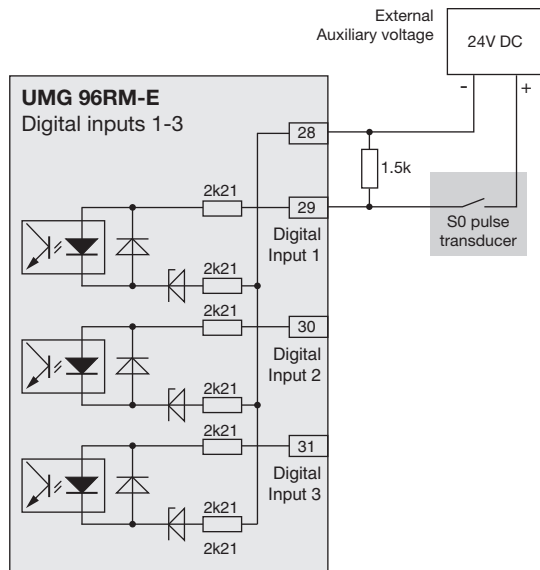

Fig. Example for the connection of an S0 pulse transducer to digital input 1.

LED status bar

The different statuses of the inputs and outputs are displayed via the LED status bar on the rear of the device.

Digital inputs

The LED assigned to a respective input lights up **green** when a signal of at least 1mA flows on this interface.

Digital outputs

The LED assigned to a respective output lights up **red** when the output is set as enabled - regardless of whether there is a continuing connection to this interface.

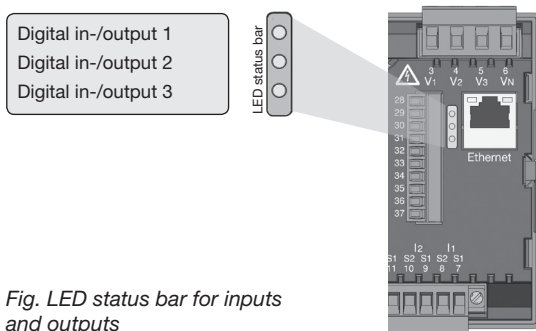

Fig. LED status bar for inputs and outputs

Operation

The UMG 96RM-E is operated via buttons 1 and 2 with the following functions:

- briefly pressing button 1 and 2:
next step (+1)
- pressing and holding button 1 and 2:
previous step (-1)

Measured values and programming data are displayed on an LCD display.

There are *display* and *programming* modes. You can avoid an unintentional change of programming data by entering a password.

Display mode

In display mode, you can scroll through the programmed measured values by pressing buttons 1 and 2. When the device is delivered, all measured value indications of profile 1 can be retrieved. For each measured value, up to three measured values are indicated. The measured value rotation can display selected measured value indications one after the other with a selectable changing time.

Programming mode

You can view and change the necessary settings of the UMG 96RM-E in programming mode. Press button 1 and 2 simultaneously for about 1 second to switch to programming mode after entering the password. If no password is programmed, you get directly to the programming mode menu. Programming mode is marked by the text „PRG“ on the display.

Press button 2 to switch between the following menus:

- Current transformer,
- Voltage transformer,
- Parameter list,
- TCP/IP device address,
- Subnet mask,
- Gateway address,
- Dynamic TCP/IP addressing (in/out).

If no button was pressed for about 60 seconds when you are in programming mode, or button 1 and 2 are pressed simultaneously for about 1 second, the UMG 96RM-E will switch back to display mode.

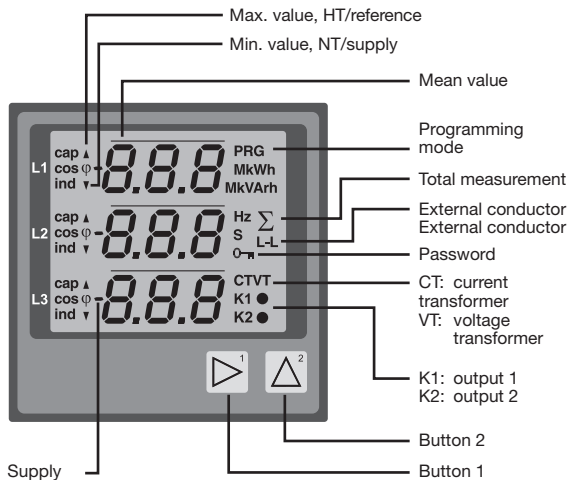

Parameters and measured values

All necessary parameters for the use of UMG 96RM-E, such as current transformer data and frequently required measured values are provided in the table. Use the UMG 96RM-E buttons to retrieve the contents of most of the addresses via serial interface.

You can only enter the first 3 significant digits of a value on the device. Values with more digits can be entered using GridVis. The first 3 significant digits of a value are displayed on the device.

Selected measured values are summarized in measured value profiles and can be indicated in display mode by pressing button 1 and 2.

The current measured value profile, the display change profile, plus date and time can be read and changed via the RS485 interface only.

Parameter indication example

In this example, the contents of address "000" is indicated by the value "001" on display of the UMG 96RM-E. This parameter specifies the device address (in this case "001") according to the list of the UMG 96 RM-E within a bus.



Measured value indication example

In this example, the voltage L-N is indicated by 230V on the display of the UMG 96RM-E. The transistor outputs K1 and K2 are active, which ensures the current flow.



Button functions

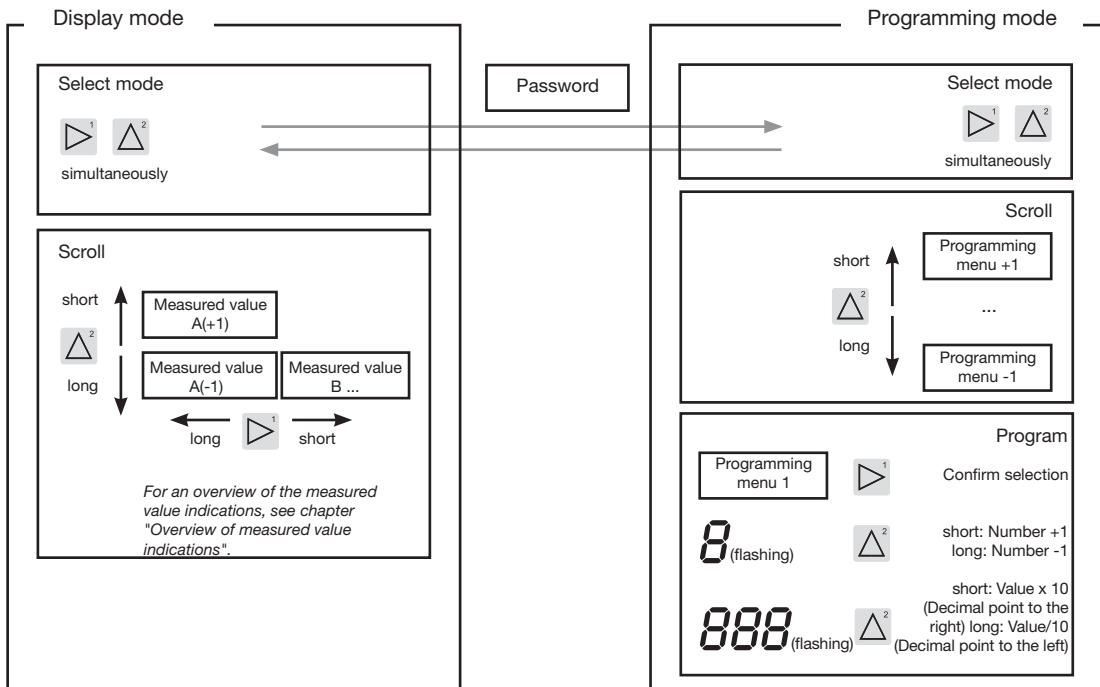

Configuration

Connecting the supply voltage

The supply voltage must be connected for the configuration of the UMG 96RM-E .

The level of the supply voltage for the UMG 96RM-E is specified on the rating plate.

If no display appears, check whether the operating voltage lies within the nominal voltage range.

Current and voltage transformers

When the device is delivered, a current transformer ratio of 5/5A is entered. The voltage transformer ratio must only be changed if a voltage transformer is connected.

When connecting a voltage transformer, please note the measurement voltage of UMG 96RM-E given on the rating plate.



Caution!

If the supply voltage does not correspond to the voltage indicated on the rating plate, this may lead to malfunctions severe damage to the device.



The adjustable value 0 for the primary current transformer does not produce any useful work data, and should not be used.



Devices with an automatic frequency detection require about 5 seconds to determine the mains frequency. In the meantime, measured values do not maintain the guaranteed measurement uncertainty.



Prior to commissioning potential production dependant contents of the energy counter, min/max values and records have to be deleted.



Current and voltage transformers

The GridVis software included with delivery can be used to individually program the current and voltage transformer input transformer ratios.

Only the transformer ratio of the respective group of the current inputs I1-I3 and the voltage measurement inputs V1-V3 can be adjusted on the device.

The transformer ratio of the *current transformer input I4* and the *residual current transformer inputs I5, I6* should be set in the GridVis software.

Current transformer input I4

Thus, with a voltage only an apparent current can be measured at the current converter input I4 due to the multiplier being missing. This input can not be used for power measurements. The transformer ratio can be adjusted in the GridVis software.

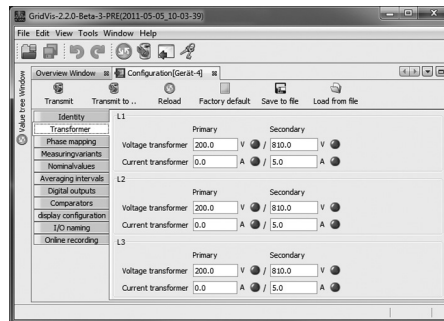

Fig. Indication to configure the current and voltage transformers in the GridVis software.

Programming the current transformer for I1 to I3

Switch to the programming mode

- Press button 1 and 2 simultaneously to switch to the programming mode. If a user password was programmed, the password menu appears in display with the indication „000“. The first digit of the user password is flashing and can be changed by pressing button 2. Press button 2 to select the next digit while it is flashing. You can get to the programming mode after entering the correct code, or if no user password was programmed.
- The symbols for the programming mode PRG and the current transformer mode CT appear on the display.
- Press button 1 to confirm the selection.
- The first digit of the input field for the primary current is flashing.

Input of the current transformer primary current

- Press button 2 to change the flashing digit.
- Press button 1 to select the next digit to be changed. The selected digit to be changed is flashing. If the entire number is flashing, press button 2 to move the decimal point.

Input of the current transformer secondary current

- Only 1A or 5A can be set as secondary current.
- Press button 1 to select the secondary current.
- Press button 2 to change the flashing digit.

Exit programming mode

- Press both buttons simultaneously to exit the programming mode.

Programming the voltage transformer

- Select in the programming mode as described. The symbols for the programming mode PRG and the current transformer mode CT appear on the display.
- Press button 2 to go to the voltage transformer settings.
- Press button 1 to confirm the selection.
- The first digit of the input field for the primary voltage is flashing. The voltage transformer ratio can be set from primary to secondary voltage in a way similar to the allocation of the current transformer ratio.

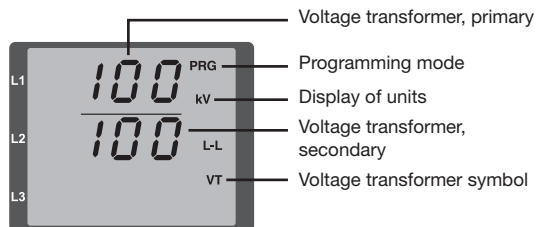
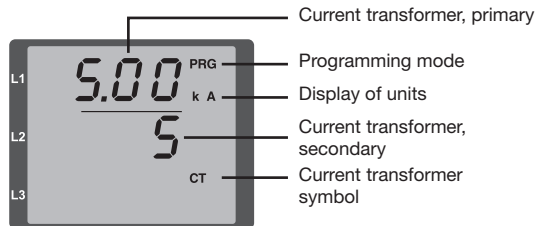

Programming parameters

Switch to the programming mode

- Select in the programming mode as described. The symbols for the programming mode PRG and the current transformer mode CT appear on the display.
- Press button 2 to go to the voltage transformer settings. Press button 2 repeatedly to view the first parameter in the list.

Changing parameters

- Press button 1 to confirm the selection.
- The last selected address and the corresponding value is indicated.
- The first digit of the address is flashing and can be changed by pressing button 2. Press button 1 to select and change the digit with button 2.

Change value

- If the desired address is set, press button 1 to select a number of the value and change it by pressing button 2.

Exit programming mode

- Press both buttons simultaneously to exit the programming mode.



Fig. Password query
Use button 1 and 2 to enter a password (if any).



Fig. Current transformer programming mode
Use button 1 and 2 to change primary and secondary current (see page 50).



Fig. Programming mode Voltage converter
Use button 1 and 2 to change primary and secondary voltage (see page 51).



Fig. Programming mode Parameter indication
Use button 1 and 2 to change individual parameters (see page 46).

TCP/IP configuration

Within an Ethernet, each device has a unique TCP / IP address that can be assigned manually or from a DHCP server. The 4-byte device address (0 to 3 byte) can be extended in the TCP / IP configuration using the subnet mask and gateway data.

Setting the TCP / IP device address (addr) manually

- Select in the programming mode as described. The symbols for the programming mode PRG and the current transformer mode CT appear on the display.
- Press button 2 three times to get to the TCP / IP settings for the device addressing.
- Press button 1 to select the desired digit. The selection is indicated by a flashing digit.
- Press button 2 to adjust the selected digit.
- Use button 1 to select the next digit and set it again by pressing button 2.
- If byte is set to 0, the TCP / IP address can be set from 1 to 3 by pressing button 1. Then the display jumps back to Byte 0 (**no** digit is flashing).

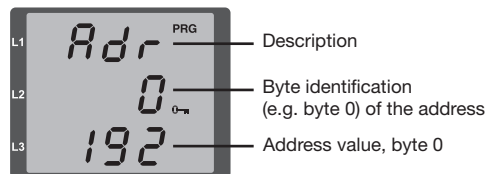

Fig. TCP/IP address, byte 1
A TCP / IP address consists of 4 bytes with the following structure:



Example: 192.168.003.177

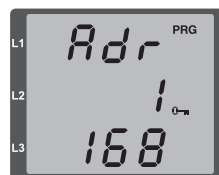

Fig. TCP / IP address,
byte 2, value 003



Fig. TCP / IP address,
byte 3, value 177

Manual setting of the subnet mask (Sub)

- When in the programming mode, press button 2 to get to the subnet mask settings (SUB display).
- Use button 1 to select the desired digit and set it by pressing button 2. Repeat this step for each digit in bytes 0 to 3 in a way similar to setting the TCP / IP device address.
- After repeated display of byte 0 (**no** digit is flashing) one can set the gateway address.

Manual setting of the gateway address (GAt)

- When in the programming mode, press button 2 to get to the gateway address settings (GAt display).
- Press buttons 1 and 2 to set the desired gateway address in bytes 0 to 3 as described above.

Disable the dynamic IP allocation (dYN IP, oFF) to ensure that the manual settings of the TCP / IP device address, subnet mask and gateway address are not overwritten by a DHCP server.



Changes will only take effect after you exit the programming mode.

Dynamic IP allocation (dyn)

The dynamic allocation of the TCP / IP settings (device/gateway address and subnet mask) provides for a fully automated integration of the device into an existing network with a DHCP server. TCP / IP settings do not need to be configured manually as they are automatically assigned by the DHCP server when the device is started.

Addresses are read out in the programming mode the same way as in the manual settings.

- Switch to the programming mode as described. The symbols for the programming mode PRG and the current transformer mode CT appear on the display.
- Press button 2 several times to display the dynamic IP allocation (dYn IP).
- Press button 1 to enable the parameter "on" or "oFF" (parameter is flashing).
- Press button 2 to select the parameter and confirm by pressing button 1. Exit the programming mode or wait about 60 seconds.



If the key symbol is displayed, the dynamic IP allocation is enabled.

Device / gateway address and subnet mask are provided and automatically accepted by the DHCP server.

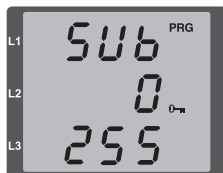

*Fig. Subnet mask (Sub),
byte 0, value 255*



*Fig. Gateway (GAt),
byte 0, value 192*

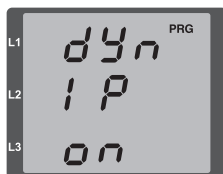

*Fig. Enabled dynamic
allocation (dYn IP)
of the TCP / IP address*

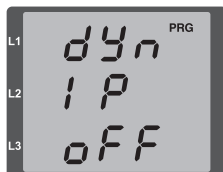

*Fig. Disabled
dynamic allocation (dYn IP)
of the TCP / IP address*



Caution!

Connection of the UMG96RM-E to the Ethernet may only be carried out after discussion with the network administrator!



Caution!

The UMG 96RM-E is factory-programmed for the dynamic allocation of the IP settings (**DHCP mode**).

Settings can be changed as described in TCP/IP Configuration or, for example, via an appropriate Ethernet connection by means of GridVis software.

RS485 device address (Addr. 000)

If multiple devices are connected to each other via the RS485 interface, a master device can only identify the devices by their device address. Within a network, each device must have its own device address. Addresses can be set in the range of 1 to 247.



The adjustable range of the device address is between 0 and 255. Values 0 and 248 through 255 are reserved and may not be used.

RS485 baud rate (Addr. 001)

A common baud rate can be adjusted for the RS485 interfaces. The baud rate must be uniform for all devices on the network. Address 003 can be used to set the number of stop bits (0=1bit, 1= 2bits). Data bits (8) and parity (none) are fixed default values.

Setting	Baud rate
0	9.6kbps
1	19.2kbps
2	38.4kbps
3	57.6kbps
4	115.2kbps (factory setting)

MODBUS gateway (Addr. 002)

Set address 002 as described in the table below to use the UMG 96RM-E Modbus Gateway function:

Setting	Baud rate
0	Modbus Gateway disabled (OFF) (Factory setting)
1	Modbus Gateway enabled (ON)

User password (Addr. 050)

A user password can be programmed to prevent accidental change of the programming data. Changes in the programming menu below can only be made after entering the correct user password.

User password is not factory-programmed. In this case, the password menu is skipped and you get directly to the current transformer menu.

If a user password was programmed, the password menu appears on the display with the indication „000“. The first digit of the user password is flashing and can be changed by pressing button 2. Press button 1 to select the next digit while it is flashing.

You can only get to the current transformer programming menu after entering the correct code.

Forgot my password

If you do not remember your password, you can only delete it using the GridVis PC software.

In order to do so, connect the UMG96RM-E to the PC with a suitable interface. More information can be found in the GridVis assistant.

Parameter

Mean value

Mean values are averaged over an adjustable period for the current, voltage and power measured values. The mean values are indicated by a bar over the measured value.

The averaging time can be selected from a list with 9 fixed averaging times.

Averaging time, current (Addr. 040)

Averaging time, power (Addr. 041)

Averaging time, voltage (Addr. 042)

Setting	Averaging time/sec.
0	5
1	10
2	15
3	30
4	60
5	300
6	480 (factory setting)
7	600
8	900

Averaging method

The applied exponential messaging method reaches at least 95% of the measurement value once the reporting time has run its course.

Min. and max. values

All measured values are measured and calculated during all 10/12 periods. Minimum and maximum values are determined for most measured values.

The min. value is the smallest measured value determined since the last deletion. The max. value is the highest measured value determined since the last deletion. All minimum and maximum values are compared with the corresponding measured values and overwritten when exceeded or fallen short of.

The minimum and maximum values are saved every 5 minutes in an EEPROM without date and time. Thus, the minimum and maximum values of the past 5 minutes may be lost due to an operating voltage failure.

Delete min. and max. values (Addr.506)

If „001“ is set for address 506, all minimum and maximum values can be deleted simultaneously.

Mains frequency (Addr. 034)

For automatic ascertainment of the mains frequency, an L1-N voltage larger than 10V_{eff} must be applied to the voltage measurement input V1.

The sampling frequency is computed for the current and voltage inputs based on the mains frequency.

If the test voltage is missing, neither the network nor the sampling frequency can be computed. An acknowledgeable error message "500" will be displayed.

Voltage, current and all resulting values are calculated and displayed based on the most recent frequency measurement and/or possible power couplings. The measured values that have been determined can no longer guarantee the declared precision.

When another measurement of frequency can be carried out, the error message will automatically disappear in about 5 seconds after the voltage returns.

The error is not displayed when a fixed frequency is set.

Setting range: 0, 45 .. 65

0 = automatic frequency determination.

The mains frequency is determined based on the measurement voltage.

45..65 = fixed frequency

The mains frequency is pre-selected as a fixed value.

Energy meter

The UMG 96RM-E has power meters for active energy, reactive energy and apparent energy.

Reset energy meter (Addr. 507)

The real, apparent and reactive energy meters can only be reset simultaneously.

Set "001" for address 507 to reset the energy meter.

Active energy reading

Total active energy

The active energy given in this example is 12 345 678 kWh

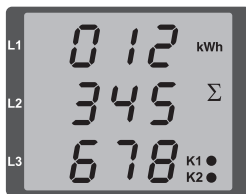

Prior to commissioning potential production dependant contents of the energy counter, min/max values and records have to be deleted.

The active energy given in this example is 134 178 kWh

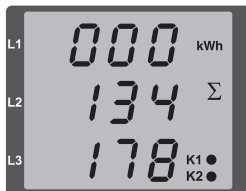

If you reset the energy meter, the data will be lost. To avoid data loss, you should read and save the measured values before deletion using the GridVis software.

Harmonics

Harmonics are integer multiples of a fundamental oscillation.

The fundamental oscillation of the voltage for UMG 96RM-E must range between 45 and 65Hz. The calculated harmonic voltages and currents relate to this fundamental oscillation.

Harmonics up to 40 times the fundamental frequency are detected.

The harmonics of the currents and of the voltages are displayed in amperes and volts, respectively.

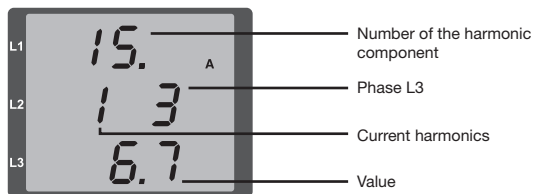

Fig. Indication of the 15th harmonics of the current in phase L3 (example).



Harmonics are not displayed in the default factory setting.

Total harmonic distortion THD

THD is the ratio of the rms value of the harmonics to the rms value of the fundamental oscillation.

Total harmonic distortion of the current THD_I:

$$THD_I = \frac{1}{|I_{fund}|} \sqrt{\sum_{n=2}^M |I_{n.Harm}|^2}$$

Total harmonic distortion of the voltage THD_U:

$$THD_U = \frac{1}{|U_{fund}|} \sqrt{\sum_{n=2}^M |U_{n.Harm}|^2}$$

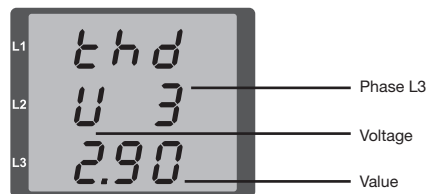

Fig. Indication of the total harmonic distortion THD of the voltage of phase L3 (example).

Measured value rotation

All 10/12 periods the measured values are calculated and the readings are displayed on a per second basis. There are two ways to retrieve the measurement readings:

- The automatically changing indication of the selected measurement readings is referred to herein as measured value rotation.
- Press button 1 and 2 to select measured value indication from a pre-selected display profile.

Both methods are available simultaneously. The measured value rotation is enabled when at least one measured value indication change time is over 0 seconds.

Press a button to scroll the measured value indications of selected display profile. If no button is pressed for about 60 seconds, the device will switch to the measured value rotation to display the programmed measured value indications from the selected rotation profile in succession.

Rotation time (Addr. 039)

Setting range : 0 .. 60 seconds

If 0 seconds are set, the measured value indications selected will not be rotated.

The rotation time set applies to all display rotation profiles.

Display rotation profile (Addr. 038)

Setting range: 0 .. 3

0 - Display rotation profile 1, pre-programmed.

1 - Display rotation profile 2, pre-programmed.

2 - Display rotation profile 3, pre-programmed.

3 - Display rotation profile, customizable.

Measured value indications

Following a power resumption, the UMG 96RM-E displays the first measurement value table in the current display profile. To keep the selection to a manageable size, only a fraction of the available measurement values was preprogrammed in the factory for retrieval in the measured value display. Select another display profile to view other measured values on the UMG 96RM-E display.

Display profile (Addr. 037)

Setting range: 0 .. 3

- 0 - Display profile 1, default value.
- 1 - Display profile 2, default value.
- 2 - Display profile 3, default value.
- 3 - Display profile, customizable.



The customizable profiles (display rotation profile and display profile) can only be programmed using the GridVis software.



Profile setting

Both profiles (display rotation profile and display profile) are illustrated in the GridVis software included in the delivery package. The profiles can be adjusted using the Device Configuration function of the software; customizable display profiles are programmed individually.

A connection between the UMG 96RM-E and the PC via an interface is required for the use of the GridVis software

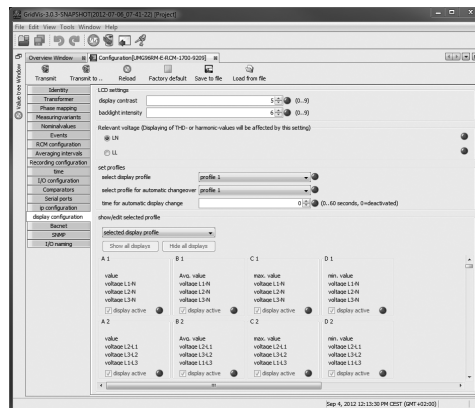

Fig. Profile setting in the GridVis software.

Phase sequence

The voltage phase sequence and the phase L1 frequency are displayed on the screen.

The phase sequence shows the three-phase system sequence. The rotary field usually rotates to the "right". The voltage measurement input phase sequence is checked and displayed in the UMG 96RM-E. If the string moves in a clockwise direction, this means that the rotary field rotates to the "right"; if the string moves in a counter-clockwise direction, this means that the rotary field rotates to the "left".

The field rotation can only be determined when the measurement and operating voltage inputs are fully connected. If a phase is missing or two equal phases are connected, then the phase sequence is not determined and the string is not moving.



Fig. Indication of the supply frequency (50.0) and the phase sequence.

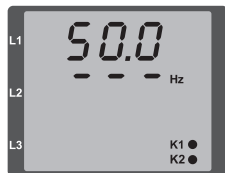

Fig. Rotary field direction can not be determined.

LCD contrast (Addr. 035)

The preferred view for the LCD display is from "below". The LCD display contrast can be adapted by the user. The contrast can be set stepwise in the range from 0 to 9.

0 = very bright
9 = very dark

Factory default setting: 5

Backlight

The LCD backlight allows the display to be read easily even in poor light. The brightness can be controlled by the user in stages from 0 to 9.

The UMG 96RM has two different types of backlight:

- the operation backlight
- the standby backlight

Operation backlight (addr. 036)

The operation backlight is activated by pushing the appropriate button, or with a restart.

Standby backlight (addr. 747)

This backlight is activated after an adjustable period of time (addr. 746). If no button is pressed within this period, then the device switches to the standby backlight.

If buttons 1 - 3 are pressed, the device switches to the operation backlight and the defined period of time begins again.

If the brightness settings for the two backlights are set to the same value, then no change is discernible between the operation and standby backlights.

Addr.	Description	Setting range	Default setting
036	Brightness for operation backlight	0 .. 9	6
746	Period of time after which the backlight will switch to standby	60 .. 9999 Sek.	900 Sek.
747	Brightness for standby backlight	0 .. 9	0

0 = min. brightness, 9 = max. brightness

Time recording

The UMG 96RM-E records the operating hours and the overall runtime of each comparator,

- where the operating period is measured and displayed in hours with a resolution of 0.1 h
- and the overall runtime of the comparators is displayed in seconds (when reaching 999999s is displayed in hours).

The periods are marked by the digits 1 to 6 for the measured value display enquiry:

keine = operating hours meter

1 = Overall runtime, comparator 1A

2 = Overall runtime, comparator 2A

3 = Overall runtime, comparator 1B

4 = Overall runtime, comparator 2B

5 = Overall runtime, comparator 1C

6 = Overall runtime, comparator 2C

In the measured value display, a maximum of 99999.9 h (= 11.4 years) can be displayed.

Operating hours meter

The operating hours meter measures the UMG 96RM-E recording and displaying time.

The operating period is measured and displayed in hours with a resolution of 0.1 h. The operating hours meter cannot be reset.

Overall runtime of comparators

The overall runtime of a comparator is the sum of the runtimes exceeding the comparator result limit value.

The total running time of the comparators can only be reset by the GridVis software. All running times are reset simultaneously.

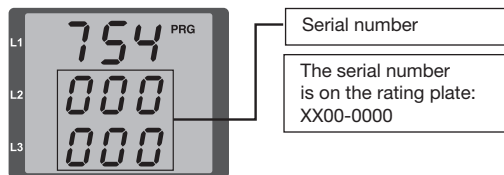

*Fig. Measured value indications
Operating hours meter
The UMG 96RM-E operating
hours meter reading is 140.8h.
This corresponds to 140 hours
and 80 industrial minutes. 100
industrial minutes = 60 minutes.
In this example, 80 industrial
minutes = 48 minutes.*

Serial number (Addr. 754)

The serial number displayed by the UMG 96RM-E consists of 6 digits and is a part of the serial number given on the rating plate.

The serial number cannot be changed.



Software release (Addr. 750)

The UMG 96RM-E software is continuously improved and extended. The software status in the device is identified with a 3 digit number, the software release. The software release cannot be changed by the user.

Recordings

2 recordings are preconfigured in the default factory setting of the UMG 96RM-E. Recordings can be adjusted and extended via GridVis.

- The min. recording time base is 1 minute.
- Maximum 4 recordings, each with 100 measured values, are possible.

Recording 1:

The following measured values are recorded with the time base of 15 minutes:

- Effective voltage L1
- Effective voltage L2
- Effective voltage L3
- Effective current L1
- Effective current L2
- Effective current L3
- Effective current sum L1..L3
- Effective power L1
- Effective power L2
- Effective power L3
- Effective power sum L1..L3
- Apparent power L1
- Apparent power L2
- Apparent power L3
- Apparent power sum L1..L3

- $\cos \phi(\text{math.})$ L1
- $\cos \phi(\text{math.})$ L2
- $\cos \phi(\text{math.})$ L3
- $\cos \phi(\text{math.})$ sum L1..L3
- Reactive power fundamental oscillation harmonic L1
- Reactive power fundamental oscillation harmonic L2
- Reactive power fundamental oscillation harmonic L3
- Reactive power fundamental oscillation harmonic sum L1..L3

The mean value, minimum value and maximum value are also recorded for each measured value.

Recording 2:

The following measured values are recorded with the time base of 1 hour:

- Effective energy sum L1..L3
- Inductive reactive energy sum L1..L3

Putting into service

Connecting the supply voltage

- The power supply voltage level for the UMG 96RM-E is given on the rating plate.
- After applying the power supply voltage the device switches on to display the first measured value.
- If no display appears, check whether the power supply voltage is within the rated voltage range.

Applying the measuring-circuit voltage

- Measurement of voltages in the mains with over 300VAC to earth must be connected via voltage transformers.
- After connecting the measurement-current voltages, the measured values displayed by the UMG 96RM-E for the L-N and L-L voltages must correspond to those at the voltage measurement input.



Caution!

Voltages and currents that are outside the permissible measuring range can lead to personal injury and damage the device.

Applying the measuring-circuit current

The UMG 96RM-E is designed for the connection of .. /1A and .. /5A current transformers.

Only AC currents can be measured via the current measurement inputs - DC currents cannot.

Short circuit all current transformer outputs except for one. Compare the currents displayed by the UMG 96RM with the applied current.

Bearing in mind the current transformer conversion ratio, the current displayed by the UMG 96RM-E must correspond with the input current.

The UMG 96RM-E must display approx. zero amperes in the short-circuited current measurement inputs.

The current transformer ratio is factory set to 5/5A and must be adapted to the current transformer used if necessary.



Caution!

If the supply voltage does not correspond to the voltage indicated on the rating plate, this may lead to malfunctions severe damage to the device.



Caution!

The UMG 96RM is not suitable for measuring DC voltages.

Phase sequence

Check the direction of the voltage rotating field in the measured value display of the UMG 96RM-E. A “right” rotating field usually exists.

Check phase assignment

The assignment of the outer conductors to the current transformer is correct, if a current transformer is short circuited on the secondary, and the current indicated by the UMG 96RM-E drops to 0A in the corresponding phase.

Checking the energy measurement

Short-circuit all current transformer outputs except for one and check the displayed power outputs. The UMG 96RM-E may only display one power output in the phase with a non short-circuited current transformer input. If this is not the case, check the connection of the measuring-circuit voltage and the measuring-circuit current.

If the power output amount is correct but the sign of the power output is negative,

- S1(k) and S2(l) could be inverted at the current transformer
- or they supply active energy back into the network.

Applying the residual current

Connect residual current transformer only to the I5 and I6 inputs with a rated current of 30mA! Both residual current inputs can measure AC currents, pulsing direct currents and DC currents.

Bearing in mind the current transformer conversion ratio, the residual current displayed by the UMG96RM-E must correspond with the input current.

The current transformer ratio is factory set to 5/5A and must be adapted to the residual current transformer used if necessary.



The UMG 96RM-E requires the mains frequency to measure the residual current. For this purpose, the measuring-circuit voltage should be applied or a fixed frequency should be set.



It is not necessary to configure a connection schematic for residual current inputs I5 and I6.

Failure monitoring (RCM) for I5, I6

The UMG96RM-E enables continuous monitoring of the connection to the residual current transformer on inputs I5 and I6.

Activation of failure monitoring is performed by setting address 21264 for the residual-current measurement input I5 and 21265 for I6.

If there is an interruption in the connection to the current transformer, this state is recorded in certain registers or indicated in the GridVis software:



The failure monitoring is only available from firmware-ver. 202 and hardware-release 104!



Monitoring of the connection to the residual current transformer is only available in AC mode!

Modbus addr.	Value / Function
21264 (I5) 21265 (I6)	Failure monitoring for I5 / I6 0 = Deactivate monitoring 1 = Activate monitoring

Modbus addr.	Value / Function
11623 (I5) 11624 (I6)	0 = Connection to the residual current transformer on to I5 or I6 error-free 1 = Error in the current transformer connection to I5 or I6

Alarm status for I5, I6

Using bit-by-bit coding inside the alarm register (addr. 21095, 21096), it is possible to read out different alarm statuses:

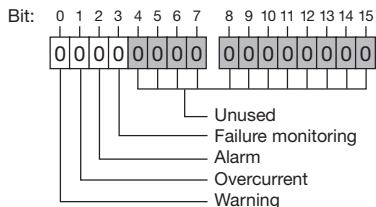

Warning:	The residual current has exceeded the set warning limit value
Overcurrent:	The measurement range has been exceeded
Alarm:	Alarm bit is set for: warning, overcurrent or connection error to the transformer. The alarm bit must be reset or acknowledged manually.
Failure monitoring	Connection error to the transformer

Example:

Interruption of the connection to the residual current transformer. The alarm bit is also set and must be acknowledged!

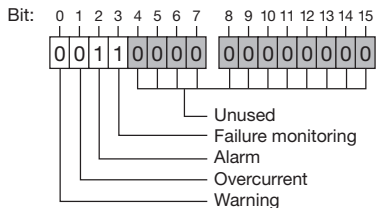

Checking the measurement

If all voltage and current inputs are correctly connected, the individual and cumulative outputs are computed and displayed correctly.

Checking the individual outputs

In case that a current transformer is assigned to the wrong outer conductor, the corresponding power output will be measured and indicated incorrectly.

The assignment of the outer conductor and the UMG 96RM-E current transformer is correct, if no voltage is measured between the outer conductor and the corresponding current transformer (primary).

In order to ensure that an outer conductor at the voltage measurement input is assigned to the correct current transformer, the respective current transformer can be short-circuited on the secondary side. The apparent power displayed by the UMG 96RM-E must then be approx. zero in this phase.

If the apparent power is correctly displayed but the active power is displayed with a „-“ sign, then the current transformer terminals are reversed or power is supplied to the power supply company.

Checking the total power outputs

If all voltages, currents and outputs for the respective outer conductors are correctly displayed, the total power outputs measured by the UMG 96RM must also be correct. To confirm this, the total outputs measured by the UMG 96RM should be compared with the work of the active and reactive power meters located in the incoming supply.

RS485 interface

The MODBUS RTU protocol with CRC check on the RS485 interface can be used to access the data from the parameter and the measured value lists.

Address range: 1 .. 247

Factory default setting: 1

The device is factory set to address 1 and the baud rate of 115,2 kbps.

Modbus functions (slave)

04 Read input registers

06 Preset single register

16 (10Hex) Preset multiple registers

23 (17Hex) Read/write 4X registers

The sequence of bytes is high before low byte (Motorola format).

Transmission parameters:

Data bits: 8

Parity: no

Stop bits (UMG 96RM): 2

External stop bits: 1 or 2

Number format: short 16 bit ($-2^{15}.. 2^{15} - 1$).

float 32 bit (IEEE 754)



Broadcast (address 0) is not supported by the device.



The message length must not exceed 256 bytes.

Example: Reading the L1-N voltage

The L1-N voltage is saved in the measured value list at address 19000. The L1-N voltage is available in the FLOAT format.

Address = 01 is approved as the UMG 96RM-E device address.

The Query Message appears as follows:

Description	Hex	Note
Device address	01	UMG 96RM, address= 1
Function	03	„Read Holding Reg.“
Start Addr. Hi	4A	19000dez = 4A38hex
Start Addr. Lo	38	
Ind. Value Hi	00	2dez = 0002hex
Ind. Value Lo	02	
Error Check	-	

The Response of the UMG96 RM-E can appear as follows:

Description	Hex	Note
Device address	01	UMG 96RM, address= 1
Function	03	
Byte meter	06	
Data	00	00hex = 00dez
Data	E6	E6hex = 230dez
Error Check (CRC)	-	

The L1-N voltage read by address 19000 is 230V.

Digital outputs

The UMG 96RM-E features two digital outputs in group 1. Three further outputs can be used in group 2.

The User can allocate different functions to the digital outputs

The functions can be programmed by using the configuration menu of the GridVis software.

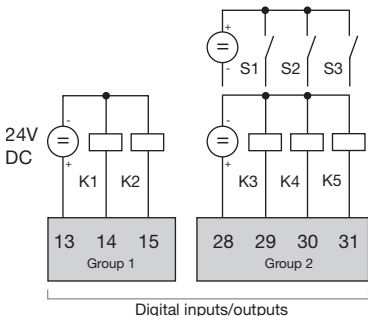

Fig.: Digital inputs of group 1 and digital in- / outputs of group 2

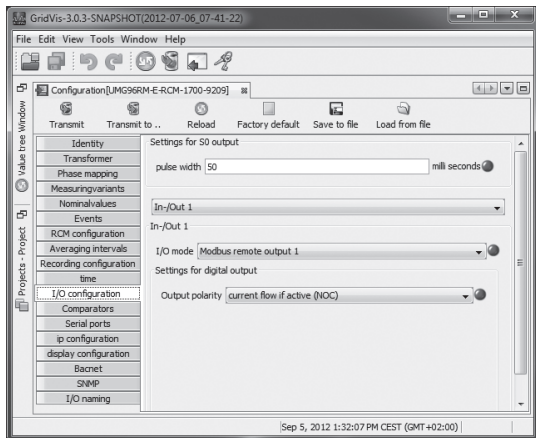

Fig.: Software GridVis, configuration menu

Digital outputs - Status displays

The status of the switching outputs of group 1 is indicated by circular symbols in the display of the UMG 96RM-E.



Since the indication is updated once per second, faster status changes of the outputs can not be displayed.

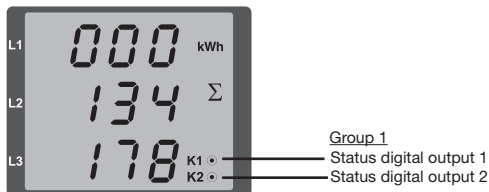

Digital output stati

- The current flow can be $<1\text{mA}$.
Digital output 1: Addr. 608 = 0
Digital output 2: Addr. 609 = 0
- The current flow can up to 50mA .
Digital output 1: Addr. 608 = 1
Digital output 2: Addr. 609 = 1

Impulse output

The digital outputs can be used for the output of pulses for the computation of power consumption. For this purpose, a pulse of defined length is applied on the output after reaching a certain, adjustable amount of power.

You need to make various adjustments in the software GridVis (configuration menu) to use a digital output as a pulse one.

- Digital output,
- Selection of source,
- Selection of measured value,
- Pulse length,
- Pulse value.

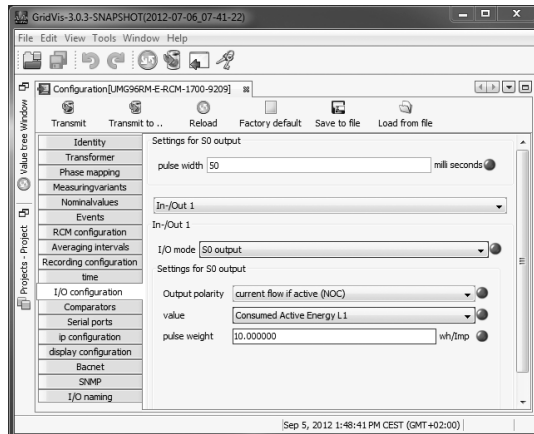

Fig.: Software GridVis, configuration menu

Pulse length

The pulse length applies to both pulse outputs and is set by the software GridVis.

The typical pulse length of S0 pulse is 30ms.

Pulse interval

The pulse interval is at least as large as the selected pulse length.

The pulse interval depends on the measured power, for example, and can take hours or days.

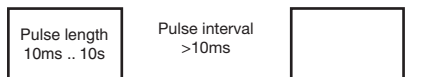

The values in the table are based on the minimum pulse length and the minimum pulse interval for the maximum number of pulses per hour.

Pulse length	Pulse interval	Max. pulse/h
10 ms	10 ms	180 000 pulse/h
30 ms	30 ms	60 000 pulse/h
50 ms	50 ms	36 000 pulse/h
100 ms	100 ms	18 000 pulse/h
500 ms	500 ms	3600 pulse/h
1 s	1 s	1800 pulse/h
10 s	10 s	180 pulse/h

Examples of the maximum possible number of pulses per hour.



Pulse interval

The pulse interval is proportional to the power output within the selected settings.



Measured value selection

When programming with GridVis you have a selection of work values which are derived from the power output values.

Pulse value

The pulse value is used to indicate how much energy (Wh or varh) should correspond to a pulse.

The pulse value is determined by the maximum connected load and the maximum number of pulses per hour.

If you check the pulse value with a positive sign, the pulses will only be emitted when the measured value has a positive sign.

If you check the pulse value with a negative sign, the pulses will only be produced when the measured value has a negative sign.

$$\text{Pulse value} = \frac{\text{max. connected load}}{\text{max. number of pulses/h}} \quad [\text{Pulse/Wh}]$$



Since the active energy meter operates with a backstop, pulses will only be generated when drawing electricity.



Since the reactive energy meter operates with a backstop, pulses will only be generated with inductive load applied.

Determine the pulse value

Set the pulse length

Set the pulse length in accordance with the requirements of the connected pulse receiver.

At a pulse length of 30 ms, for example, the UMG96RM generates a maximum number of 60,000 pulses (see Table "maximum number of pulses" per hour.

Determining the maximum connected load

Example:

$$\begin{aligned} \text{Current transformer} &= 150/5\text{A} \\ \text{Voltage L-N} &= \text{max. } 300\text{ V} \end{aligned}$$

$$\begin{aligned} \text{Power per phase} &= 150\text{ A} \times 300\text{ V} \\ &= 45\text{ kW} \end{aligned}$$

$$\begin{aligned} \text{Power at 3 phases} &= 45\text{kW} \times 3 \\ \text{Max. connected load} &= 135\text{kW} \end{aligned}$$

Calculating the pulse value

$$\text{Pulse value} = \frac{\text{max. connected load}}{\text{max. number of pulses/h}} \quad [\text{Pulse/Wh}]$$

$$\begin{aligned} \text{Pulse value} &= 135\text{kW} / 60,000 \text{ Imp/h} \\ \text{Pulse value} &= 0,00225 \text{ pulse/kWh} \\ \text{Pulse value} &= 2,25 \text{ pulse/Wh} \end{aligned}$$

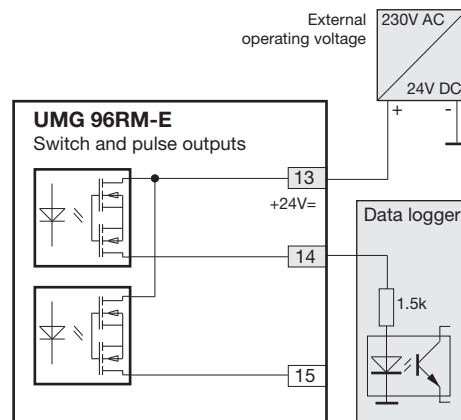

Fig.: Connection example for the circuit as pulse output.



When using the digital outputs as pulse outputs the auxiliary voltage (DC) must have a max. residual ripple of 5%.

Comparators and monitoring threshold values

Five comparator groups (1-5) and 10 comparators per group (A – J) can be selected in order to monitor/control the thresholds. The results of the comparators A to J can be linked with AND or OR operators

The result of the AND and OR operator can be allocated to the respective digital output.

The function “display blinking” can be additionally assigned to every comparator group. The effect is the change of the display backlight between maximum and minimum brightness when the comparator output is active.

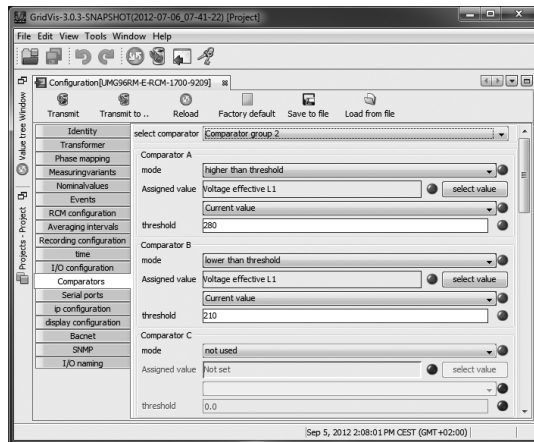

Fig.: Software GridVis, configuration menu

Comparator running times

Comparator running times are time counters, which are added together at a set comparator output. i.e. if the condition of the comparator is fulfilled and the lead time has elapsed, the counter is increased by the corresponding amount of time - this does not take account of the min. switch-on time!

Comparator with set limit value violation

- The set limit value is compared to the measured value.
- If the limit value violation occurs for at least the duration of the lead time, the comparator result is changed.
- The result is retained for at least the duration of the min. switch-on time and for no longer than the duration of the limit value violation. If there is no longer a limit value violation and the min. switch-on time has elapsed, the result is reset.

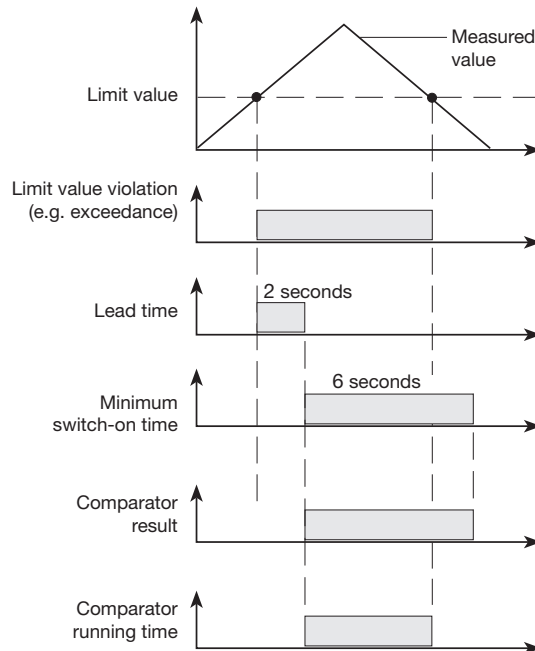

Service and maintenance

The device is subjected to several different safety tests before leaving the factory and is labelled with a seal. If a device is opened then the safety checks must be repeated. Warranty claims will only be accepted if the device is unopened.

Repair and calibration

Repair work and calibration can be carried out by the manufacturer only.

Front film

The front film can be cleaned with a soft cloth and standard household cleaning agent. Do not use acids and products containing acid for cleaning.

Disposal

The UMG 96RM can be reused or recycled as electronic scrap in accordance with the legal provisions. The permanently installed lithium battery must be disposed of separately.

Service

Should questions arise, which are not described in this manual, please contact the manufacturer directly.

We will need the following information from you to answer any questions:

- Device name (see rating plate),
- Serial number (see rating plate),
- Software release (see measured value display),
- Measuring-circuit voltage and power supply voltage,
- Precise description of the error.

Device calibration

The devices are calibrated by the manufacturer at the factory - it is not necessary to recalibrate the device providing that the environmental conditions are complied with.

Calibration intervals

It is recommended to have a new calibration carried out by the manufacturer or an accredited laboratory every 5 years approximately.

Firmware update

If the device is connected to a computer via Ethernet, then the device firmware can be updated via the GridVis software.

Select a suitable update file (menu *Extras / Update device*) and the device and the new firmware will be transferred.

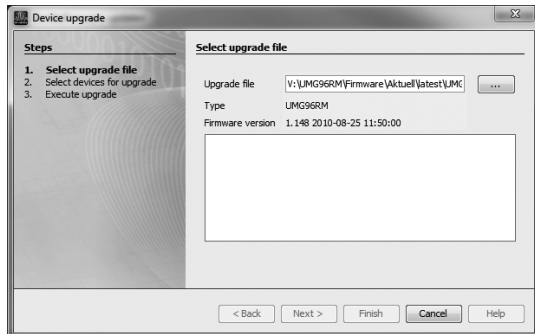

Fig. GridVis firmware update assistant



Firmware may NOT be updated via the RS485 interface.

Battery

The internal clock is fed from the supply voltage. If the supply voltage fails then the clock is powered by the battery. The clock provides date and time information, for the records, min. and max. values and results, for example.

The life expectancy of the battery is at least 5 years with a storage temperature of +45°C. The typical life expectancy of the battery is 8 to 10 years.

The battery is replaced via the battery insert provided on the rear of the device. Make sure that the correct type of battery is used and correct polarity is observed when inserting the battery (positive pole faces the rear of the device; negative pole faces the front).

See chapter "Changing the battery" for more information.

Battery monitoring function

The device indicates the condition of the battery via the "EEE" symbol followed by "bAt" and the status number. Depending on the status number a confirmation of the information by the operator may be required. It is recommended that the battery be replaced.

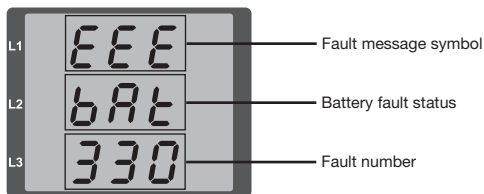

Status	Status description
EEE bAt 321	<ul style="list-style-type: none"> • Battery capacity is <85% • Operator confirmation required • Message appears weekly after confirmation • Battery should be replaced
EEE bAt 322	<ul style="list-style-type: none"> • Battery capacity is <75% • Battery capacity is too low • Can only be detected after resumption of mains power • Battery should be replaced
EEE bAt 330	<ul style="list-style-type: none"> • Battery capacity OK • Message can be acknowledged • Clock is stopped and must be set
EEE bAt 331	<ul style="list-style-type: none"> • Battery capacity is <85% • Clock is stopped and must be set • Operator confirmation required • Message appears weekly after confirmation • Battery should be replaced
EEE bAt 332	<ul style="list-style-type: none"> • Battery capacity is <75% • Clock is stopped and must be set • Operator confirmation required • Message appears daily after confirmation • Battery should be replaced

Replacing the battery

If the battery capacity is shown as < 75 %, we recommend that the battery be replaced.

Procedure

1. Disconnect system and device from power supply before beginning work.
2. Discharge any electrostatic charge in your body, e. g. by touching an earthed cabinet or metal part (radiator) connected to the earth of the building.
3. Remove the battery from the battery compartment, —e.g. using long-nose pliers—. **The device does not need to be opened to do this as the battery compartment can be accessed from the outside (see figure on the right).**
4. Make sure that the polarity is as shown on the insertion opening of the battery compartment and slide the replacement battery into the battery compartment. For this, use a battery compliant with the description in the technical data. The battery must fulfil the safety requirements of UL1642. Otherwise, there is a risk of combustion or explosion.
5. Dispose of the old battery according to the legal regulations.
6. Start up the system and the device again and check the functionality of the UMG 96-RM. Set the date and time.



Fig. Battery insertion on the rear



Grease or dirt on the contact surfaces form a transfer resistance that will shorten the life of the battery. Only touch the battery at the edges.



Dangerous voltage!

Danger to life or risk of serious injury. Disconnect system and device from power supply before beginning work.



Make sure that the correct type of battery is used and observe correct polarity when changing it.

Error/warning messages

The UMG 96RM-E can display four different error messages:

- warnings,
- clock/battery errors,
- fatal errors and
- overranges.

In the case of warnings and fatal errors, the error message is followed by the "EEE" symbol and an error number.

The three-digit error number consists of the error description and - if set from the UMG 96RM - one or more error causes.

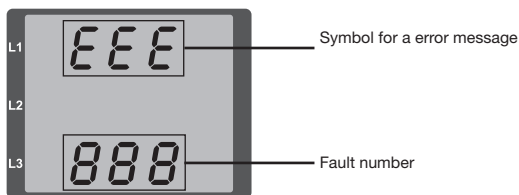

Fig. Error message

Warnings

Warnings are minor errors that can be acknowledged by buttons 1 or 2. The measured values continue to be retrieved and displayed. This error is displayed after each voltage return.



Fig. Warning message with number 500 (mains frequency)

Errors	Error description
EEE 500	<p>The mains frequency could not be determined.</p> <p>Possible causes:</p> <ul style="list-style-type: none"> The voltage at L1 is too small. The mains frequency does not range between 45 and 65Hz. <p>Remedy:</p> <ul style="list-style-type: none"> Check the mains frequency. Select fixed frequency on the device.

Clock/battery errors

Clock or battery errors are displayed together with the "EEE" symbol followed by "bAt" and a status number. For a more detailed description please refer to "Battery control function" and "Replacing the battery".



Fig. Clock / battery error number 330 (clock does not run and has to be set).

Major errors

When a major error occurs, the device must be sent to the manufacturer's service center for inspection and adjustment.

Errors	Error description
EEE 910	Error while reading the calibration.

Internal causes:

The UMG 96RM-E sometimes determines the cause of a major internal error with the following error code.

Errors	Error description
0x01	EEPROM does not respond.
0x02	Address overrange.
0x04	Checksum error.
0x08	Error in the internal I2C bus.

Example, error message 911:

The error number consists of major error 910 and internal error cause 0x01.

In this example an error occurred while reading the calibration data from EEPROM. The device has to be returned to the manufacturer for inspection and adjustment.

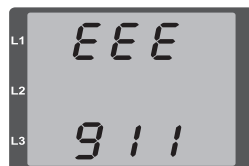

Overranges

Overranges are displayed as long as they exist and cannot be acknowledged. An overrange exists if at least one of the four voltage or current measurement inputs lies outside their specified measuring range.

The "upwards" arrow indicates the phase where the overrange occurred. The appropriate error message for current path I4 is generated as shown below.

The "V" and "A" symbols indicate whether the overrange occurred in the current or in the voltage path.

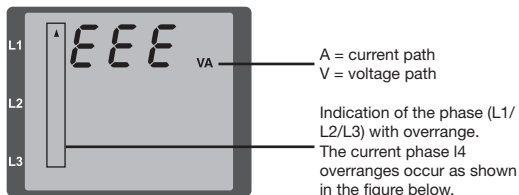

Overrange limits:

$$I = 7 A_{eff}$$

$$U_{L-N} = 520 V_{L-N}$$

Examples

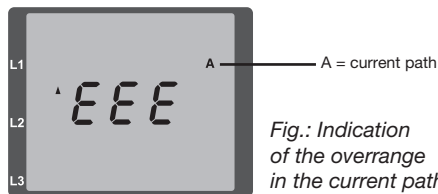

Fig.: Indication of the overrange in the current path of phase 2 (I2).

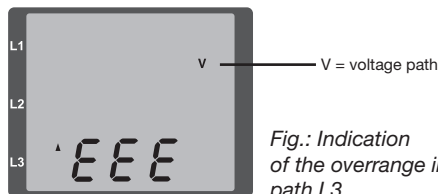

Fig.: Indication of the overrange in voltage path L3.

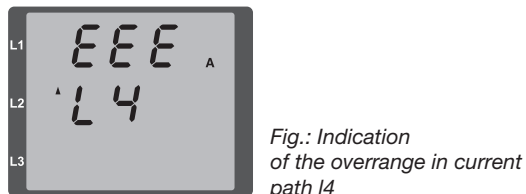

Fig.: Indication of the overrange in current path I4

Parameter overrange

A detailed description of the error is coded in the parameter overrange (Addr. 600) in the following format:

0x	F	F	F	F	F	F	F	F	F
Phase 1:		1			1				
Phase 2:		2			2				
Phase 3:		4			4				
Phase 4 (I4):		8			8				
		Current:			U _{L-N}				

Example: Error in phase 2 in the current path:

0xF2FFFFFF

Example: Error in phase 3 in the voltage path U_{L-N}:

0xFFF4FFFF

Procedure in the event of faults

Possible fault	Cause	Remedy
No display	External fusing for the power supply voltage has tripped.	Replace fuse.
No current display	Measurement voltage is not connected.	Connect the measuring-circuit voltage.
	Measurement current is not connected.	Connect measuring-circuit current.
Current displayed is too large or too small.	Current measurement in the wrong phase.	Check connection and correct if necessary.
	Current transformer factor is incorrectly programmed.	Read out and program the current transformer transformation ratio at the current transformer.
	The current peak value at the measurement input was exceeded by harmonic components.	Install current transformer with a larger transformation ratio.
	The current at the measurement input fell short of.	Install current transformer with a suitable transformation ratio.
Voltage displayed is too large or too small.	Measurement in the wrong phase.	Check connection and correct if necessary.
	Voltage transformer incorrectly programmed.	Read out and program the voltage transformer transformation ratio at the voltage transformer.
Voltage displayed is too small.	Overrange.	Install voltage transformers.
	The peak voltage value at the measurement input has been exceeded by harmonic components.	Caution! Ensure the measurement inputs are not overloaded.
Phase shift ind/cap.	A current path is assigned to the wrong voltage path.	Check connection and correct if necessary.
Effective power, consumption/supply reversed.	At least one current transformer connection is mixed up/reversed.	Check connection and correct if necessary.
	A current path is assigned to the wrong voltage path.	Check connection and correct if necessary.

Possible fault	Cause	Remedy
Effective power too large or too small.	The programmed current transformer transformation ratio is incorrect.	Read out and program the current transformer transformation ratio at the current transformer
	The current path is assigned to the wrong voltage path.	Check connection and correct if necessary.
	The programmed voltage transformer transformation ratio is incorrect.	Read out and program the voltage transformer transformation ratio at the voltage transformer.
An output is not responding.	The output was incorrectly programmed.	Check the settings and correct if necessary.
	The output was incorrectly connected.	Check connection and correct if necessary.
"EEE" in the display	See error messages.	
"EEE bAt" in the display	Battery capacity is too low	See "Battery control function" and "Replacing the battery"
No connection with the device.	RS485 - Device address is incorrect. - Different bus speeds (Baud rate). - Wrong protocol. - Termination missing.	- Adjust the device address. - Adjust speed (baud rate). - Select the correct protocol. - Close bus with termination resistor.
	Ethernet - IP address is incorrect. - Incorrect addressing mode	- Adjust IP address at the device. - Adjust the IP address assignment mode
Device still does not work despite the above measures.	Device defective.	Send the device to the manufacturer for inspection and testing along with an accurate fault description.

Technical data

General information	
Net weight (with attached connectors)	approx. 370g
Packaging weight (including accessories)	approx. 950g
Battery	Lithium battery CR2032, 3V (approval i.a.w. UL 1642)
Service life of background lighting	40000h (after this period of time the background lighting efficiency will reduce by approx. 50 %)

Transport and storage	
The following information applies to devices which are transported or stored in the original packaging.	
Free fall	1m
Temperature	K55 (-25°C to +70°C)
Relative humidity	0 to 90 % RH

Ambient conditions during operation

The UMG 96RM is intended for weather-protected, stationary use.
Protection class II i.a.w. IEC 60536 (VDE 0106, Part 1).

Operating temperature range	K55 (-10°C .. +55°C)
Relative humidity	0 to 75 % RH
Operating altitude	0 .. 2000m above sea level
Degree of pollution	2
Mounting position	vertical
Ventilation	Forced ventilation is not required.

Protection against ingress of solid foreign bodies and water	
- Front side	IP40 i.a.w. EN60529
- Rear side	IP20 i.a.w. EN60529
- Front with seal	IP42 i.a.w. EN60529

Power supply voltage

Installations of overvoltage category	300V CAT II
Protection of the supply voltage (fusing)	6A, type C (approved i.a.w. UL/IEC)
Nominal range	20V - 250V (45..65Hz) or DC 20V - 300V
Operating range	+/-10% of nominal range
Power consumption	max. 13VA / 5W

Digital outputs

2 and 3 optional digital outputs, semiconductor relays, not short-circuit proof.

Switching voltage	max. 33V AC, 60V DC
Switching current	max. 50mAeff AC/DC
Response time	10/12 periods + 10ms *
Pulse output (energy pulse)	max. 50Hz

* Response time e.g. at 50Hz: 200ms + 10ms = 210 ms

Digital inputs

3 optional digital inputs, semiconductor relays, not short-circuit proof.

Maximum counter frequency	20Hz
Input signal present	18V .. 28V DC (typical 4mA)
Input signal not present	0 .. 5V DC, current less than 0.5A

Temperature measurement input 2 optional inputs.	
Update time	1 second
Connectable sensors	PT100, PT1000, KTY83, KTY84
Total burden (sensor + cable)	max. 4 kOhm

Sensor type	Temperature range	Resistor range	Uncertainty in measurement
KTY83	-55°C ... +175°C	500Ohm ... 2,6kOhm	± 1,5% rng
KTY84	-40°C ... +300°C	350Ohm ... 2,6kOhm	± 1,5% rng
PT100	-99°C ... +500°C	60Ohm ... 180Ohm	± 1,5% rng
PT1000	-99°C ... +500°C	600Ohm ... 1,8kOhm	± 1,5% rng



Cable length (digital inputs and outputs, temperature measurement input)	
Up to 30m	Unshielded
More than 30m	Shielded

Serial interface	
RS485 - Modbus RTU/Slave	9.6kbps, 19.2kbps, 38.4kbps, 57.6 kbps, 115.2kbps
Stripping length	7mm

Measuring voltage	
Three-phase 4-conductor systems with nominal voltages up to	277V/480V (+-10%)
Three-phase 3-conductor systems, unearthed, with nominal voltages up to	IT 480V (+-10%)
Overvoltage category	300V CAT III
Measurement surge voltage	4kV
Measurement range L-N	0 ¹⁾ .. 300Vrms (max. surge voltage 520Vrms)
Measurement range L-L	0 ¹⁾ .. 520Vrms (max. surge voltage 900Vrms)
Resolution	0.01V
Crest factor	2,45 (related to the measurement range)
Impedance	4MΩm/phase
Power consumption	approx. 0,1VA
Sampling frequency	21.33kHz (50Hz); 25.6 kHz (60Hz) per measurement channel
Frequency range of the basic oscillation - Resolution	45Hz .. 65Hz 0.01Hz

¹⁾ The UMG 96RM-E can only determine values, if a voltage L-N greater than 10Veff or a voltage L-L of greater than 18Veff is present at at least one voltage measurement input.

Current measurement I1 - I4	
Rated current	5A
Measurement range	0 .. 6Arms
Crest factor	1.98
Resolution	0.1mA (Display 0.01A)
Overvoltage category	300V CAT II
Measurement surge voltage	2kV
Power consumption	approx. 0.2 VA (Ri=5mOhm)
Overload for 1 sec.	120A (sinusoidal)
Sampling frequency	20kHz

Residual current measurement I5 / I6	
Rated current	30mArms
Measurement range	0 .. 40mArms
Operating current	50μA
Resolution	1μA
Crest factor	1.414 (related to 40mA)
Burden	4 Ohm
Overload for 1 sec.	5A
Sustained overload	1A
Overload for 20 ms	50A
Residual current measurement	i.a.w. IEC/TR 60755 (2008-01), Type A  Type B 

Ethernet connection	
Connection	RJ45
Functions	Modbus gateway, embedded web server (HTTP)
Protocols	TCP/IP, DHCP-Client (BootP), Modbus/TCP (Port 502), ICMP (Ping), NTP, Modbus RTU over Ethernet (Port 8000), FTP, SNMP

Terminal connection capacity (power supply voltage)	
Conductors to be connected. Only one conductor can be connected per terminal!	
Single core, multi-core, fine-stranded	0.2 - 2.5mm ² , AWG 26 - 12
Terminal pins, core end sheath	0.2 - 2.5mm ²
Tightening torque	0.4 - 0.5Nm
Stripping length	7mm

Terminal connection capacity (voltage and current measurement)

Conductors to be connected. Only one conductor can be connected per terminal!

	Current	Voltage
Single core, multi-core, fine-stranded	0.2 - 2.5mm ² , AWG 26-12	0.08 - 4.0mm ² , AWG 28-12
Terminal pins, core end sheath	0.2 - 2.5mm ²	0.2 - 2.5mm ²
Tightening torque	0.4 - 0.5Nm	0.4 - 0.5Nm
Stripping length	7mm	7mm

Terminal connection capacity (residual current or temperature measurement inputs and digital inputs / outputs)

Rigid/flexible	0.14 - 1.5mm ² , AWG 28-16
Flexible with core end sheath without plastic sleeve	0.20 - 1.5mm ²
Flexible with core end sheath with plastic sleeve	0.20 - 1.5mm ²
Tightening torque	0.20 - 0.25Nm
Stripping length	7mm

Terminal connection capacity: serial interface

Single core, multi-core, fine-stranded	0.20 - 1.5mm ²
Terminal pins, core end sheath	0.20 - 1.5mm ²
Tightening torque	0.20 - 0.25Nm
Stripping length	7mm

Function parameters

Function	Symbol	Precision class	Measurement range	Display range
Total effective power	P	0.5 ⁵⁾ (IEC61557-12)	0 .. 5.4 kW	0 W .. 999 GW *
Total reactive power	QA, Qv	1 (IEC61557-12)	0 .. 5.4 kvar	0 varh .. 999 Gvarh *
Total apparent power	SA, Sv	0.5 ⁵⁾ (IEC61557-12)	0 .. 5.4 kVA	0 VA .. 999 GVA *
Total active energy	Ea	0.5S ^{5) 6)} (IEC61557-12)	0 .. 5.4 kWh	0 Wh .. 999 GWh *
Total reactive power	ErA, ErV	1 (IEC61557-12)	0 .. 5.4 kvarh	0 varh .. 999 Gvarh *
Total apparent energy	EapA, EapV	0.5 ⁵⁾ (IEC61557-12)	0 .. 5.4 kVAh	0 VAh .. 999 GVAh *
Frequency	f	0.05 (IEC61557-12)	45 .. 65Hz	45.00Hz .. 65.00Hz
Phase current I1 - I3	I	0.2 (IEC61557-12)	0 .. 6 Arms	0 A .. 999 kA
Measured neutral conductor current I4	IN	1 (IEC61557-12)	0 .. 6 Arms	0 A .. 999 kA
Residual currents I5, I6	IRes	1 (IEC61557-12)	0 .. 30 mArms	0 A .. 999 kA
Computed neutral conductor current	INc	1.0 (IEC61557-12)	0.03 .. 25 A	0.03 A .. 999 kA
Voltage	U L-N	0.2 (IEC61557-12)	10 .. 300 Vrms	0 V .. 999 kV
Voltage	U L-L	0.2 (IEC61557-12)	18 .. 520 Vrms	0 V .. 999 kV
Power factor	PFA, PFV	0.5 (IEC61557-12)	0.00 .. 1.00	0.00 .. 1.00
Short-term flicker, long-term flicker	Pst, Plt	-	-	-
Voltage drops (L-N)	Udip	-	-	-
Voltage increases (L-N)	Uswl	-	-	-
Transient overvoltages	Utr	-	-	-
Voltage drops	Unit	-	-	-
Voltage unbalance (L-N) ¹⁾	Unba	-	-	-
Voltage unbalance (L-N) ²⁾	Unb	-	-	-
Voltage harmonics	Uh	KI. 1 (IEC61000-4-7)	up to 2.5 kHz	0 V .. 999 kV
THD of the voltage ³⁾	THDu	1.0 (IEC61557-12)	up to 2.5 kHz	0 % .. 999 %
THD of the voltage ⁴⁾	THD-Ru	-	-	-

Function	Symbol	Precision class	Measurement range	Display range
Current harmonics	lh	Kl. 1 (IEC61000-4-7)	up to 2.5 kHz	0 A .. 999 kA
THD of the current ³⁾	THDi	1.0 (IEC61557-12)	up to 2.5 kHz	0 % .. 999 %
THD of the current ⁴⁾	THD-Ri	-	-	-
Mains signal voltage	MSV	-	-	-

1) Referred to amplitude.

2) Referred to phase and amplitude.

3) Referred to mains frequency.

4) Referred to root mean square value.

5) Accuracy class 0.5 with ± 5 A transformer.

Accuracy class 1 with ± 1 A transformer.

6) Accuracy class 0.5S according IEC62053-22

* The display returns to 0 W when the maximum total energy values are reached.

Parameter and modbus address list

The following excerpt of the parameter list provides the settings that are necessary for the proper operation of the UMG 96RM-E, such as current transformer and device addresses. The values in the parameter list can be set and read.



A complete overview of the parameters and measured values as well as explanations regarding the selected measured values is filed in the document “Modbus Address List” on the CD or Internet.

The excerpt of the measured value list includes the measured and calculated values, output status data and recorded values to be read.



The addresses contained in the description can be adjusted directly on the device in the range from 0 to 800. The address range above 1000 can only be processed via modbus!

Table 1 – Parameter list

Address	format	RD/WR	Unit	Note	Adjustment range	Default
0	SHORT	RD/WR	-	Device address	0..255 ⁽¹⁾	1
1	SHORT	RD/WR	kbps	Baud rate (0=9.6kbps, 1=19.2kbps, 2=38.4kbps, 3= 57.6kbps, 4=115.2kbps)	0..7 (5..7 only for internal use)	4
2	SHORT	RD/WR	-	Modbus Master 0=Slave, 1=Master (if Ethernet is provided)	0, 1	0
3	SHORT	RD/WR	-	Stop bits (0=1Bit, 1=2Bits)	0, 1	0
10	FLOAT	RD/WR	A	Current transformer I1, primary	0..1000000 ⁽²⁾	5
12	FLOAT	RD/WR	A	Current transformer I1, sec.	1..5	5
14	FLOAT	RD/WR	V	Voltage transformer V1, prim.	0..1000000 ⁽²⁾	400
16	FLOAT	RD/WR	V	Voltage transformer V1, sec.	100, 400	400
18	FLOAT	RD/WR	A	Current transformer I2, primary	0..1000000 ⁽²⁾	5

⁽¹⁾ Values 0 and 248 through 255 are reserved and may not be used.

⁽²⁾ The adjustable value of 0 does not produce any useful work values and must not be used.

Address	format	RD/WR	Unit	Note	Adjustment range	Default
20	FLOAT	RD/WR	A	Current transformer I2, sec.	1..5	5
22	FLOAT	RD/WR	V	Voltage transformer V2, prim.	0..1000000	400
24	FLOAT	RD/WR	V	Voltage transformer V2, sec.	100, 400	400
26	FLOAT	RD/WR	A	Current transformer I3, primary	0..1000000	5
28	FLOAT	RD/WR	A	Current transformer I3, sec.	1..5	5
30	FLOAT	RD/WR	V	Voltage transformer V3, prim.	0..1000000	400
32	FLOAT	RD/WR	V	Voltage transformer V3, sec.	100, 400	400
34	SHORT	RD/WR	Hz	Frequency estimation 0=Auto, 45 .. 65=Hz	0, 45 .. 65	0
35	SHORT	RD/WR	-	Display contrast 0 (low), 9 (high)	0 .. 9	5
36	SHORT	RD/WR	-	Background lighting 0 (dark), 9 (bright)	0 .. 9	6
37	SHORT	RD/WR	-	Display profile 0=preset display profile 1=preset display profile 2=preset display profile 3=customizable display profile	0 .. 3	0
38	SHORT	RD/WR	-	Display rotation profile 0..2=preset display rotation profile 3=customizable display rotation profile	0 .. 3	0
39	SHORT	RD/WR	s	Rotation time	0 .. 60	0
40	SHORT	RD/WR	-	Reporting time, I	0 .. 8*	6
41	SHORT	RD/WR	-	Reporting time, P	0 .. 8*	6
42	SHORT	RD/WR	-	Reporting time, U	0 .. 8*	6
45	USHORT	RD/WR	mA	Response threshold of current measuring I1 .. I3	0 .. 50	5

* 0 = 5sec.; 1 = 10sec.; 2 = 15sec.; 3 = 30sec.; 4 = 1min.; 5 = 5min.; 6 = 8min.; 7 = 10min.; 8 = 15min.

Address	format	RD/WR	Unit	Note	Adjustment range	Default
50	SHORT	RD/WR	-	Password	0 .. 999	0 (No password)
100	SHORT	RD/WR	-	Measured value address, Digital output 1	0..32000	874
101	SHORT	RD/WR	-	Measured value address, Digital output 2	0..32000	882
102	FLOAT	RD/WR	Wh	Pulse value, Digital output 1	-1000000..+1000000	1000
104	FLOAT	RD/WR	Wh	Pulse value, Digital output 2	-1000000..+1000000	1000
106	SHORT	RD/WR	10ms	Min. pulse length (1=10ms) Digital output 1/2	1..1000	5 (=50ms)
500	SHORT	RD/WR	-	Connector pin assignment, I L1	-3..0..+3	+1
501	SHORT	RD/WR	-	Connector pin assignment, I L2	-3..0..+3	+2
502	SHORT	RD/WR	-	Connector pin assignment, I L3	-3..0..+3	+3
503	SHORT	RD/WR	-	Connector pin assignment, U L1	0..3	1
504	SHORT	RD/WR	-	Connector pin assignment, U L2	0..3	2
505	SHORT	RD/WR	-	Connector pin assignment, U L3	0..3	3
506	SHORT	RD/WR	-	Min- und Reset max. values	0..1	0
507	SHORT	RD/WR	-	Reset energy meter	0..1	0
508	SHORT	RD/WR	-	force EEPROM descr.	0..1	0
Note: Energy values and min-max values are recorded into the EEPROM every 5 minutes.						
509	SHORT	RD/WR	-	Voltage connection diagram	0..7	0
510	SHORT	RD/WR	-	Current connection diagram	0..8	0
511	SHORT	RD/WR	-	Relevant voltage for THD and FFT	0, 1	0
The THD and FFT voltages can be displayed as L-N or L-L values. 0=LN, 1=LL						

Address	format	RD/WR	Unit	Note	Adjustment range	Default
512	SHORT	RD/WR	-	Year	0..99 ²	
513	SHORT	RD/WR	-	Month	0..12 ²	
514	SHORT	RD/WR	-	Day	0..31 ²	
515	SHORT	RD/WR	-	Hour	0..24 ²	
516	SHORT	RD/WR	-	Minute	0..59 ²	
517	SHORT	RD/WR	-	Second	0..59 ²	
600	UINT	RD/WR	-	Overrange	0..0xFFFFFFFF	
750	SHORT	RD	-	Software release		
754	SERNR	RD	-	Serial number		
756	SERNR	RD	-	Production no.		
746	SHORT	RD/WR	s	Period of time after which the backlight will switch to standby Brightness of the standby backlight	60 .. 9999 0 .. 9	900 0
747	SHORT	RD/WR	s			



Only the first 3 digits (###) of a value are displayed on the screen. Values greater than 1000 are marked with "k". Example: 003k = 3000

Table 2 - Modbus address list

(frequently needed measured values)



The addresses contained in the description can be adjusted directly on the device in the range from 0 to 800.

The address range 800-999 is available for programming comparators on the device. The addresses above 1000 can only be processed via modbus!



A complete overview of the parameters and measured values as well as explanations regarding the selected measured values is filed in the document "Modbus Address List" on the CD or Internet.

Modbus Address	address via Display	Format	RD/WR	Unit	Note
19000	808	float	RD	V	Voltage L1-N
19002	810	float	RD	V	Voltage L2-N
19004	812	float	RD	V	Voltage L3-N
19006	814	float	RD	V	Voltage L1-L2
19008	816	float	RD	V	Voltage L2-L3
19010	818	float	RD	V	Voltage L3-L1
19012	860	float	RD	A	Current, L1
19014	862	float	RD	A	Current, L2
19016	864	float	RD	A	Current, L3
19018	866	float	RD	A	Vector sum; $IN=I1+I2+I3$
19020	868	float	RD	W	Real power L1
19022	870	float	RD	W	Real power L2
19024	872	float	RD	W	Real power L3
19026	874	float	RD	W	Sum; $Psum3=P1+P2+P3$
19028	884	float	RD	VA	Apparent power S L1
19030	886	float	RD	VA	Apparent power S L2

Modbus address	Address via Display	Format	RD/WR	Unit	Note
19032	888	float	RD	VA	Apparent power S L3
19034	890	float	RD	VA	Sum; Ssum3=S1+S2+S3
19036	876	float	RD	var	Fund. reactive power (mains frequ.) Q L1
19038	878	float	RD	var	Fund. reactive power (mains frequ.) Q L2
19040	880	float	RD	var	Fund. reactive power (mains frequ.) Q L3
19042	882	float	RD	var	Sum; Qsum3=Q1+Q2+Q3
19044	820	float	RD	-	Fund.power factor, CosPhi; U L1-N IL1
19046	822	float	RD	-	Fund.power factor, CosPhi; U L2-N IL2
19048	824	float	RD	-	Fund.power factor, CosPhi; U L3-N IL3
19050	800	float	RD	Hz	Measured frequency
19052	-	float	RD	-	Rotation field; 1=right, 0=none, -1=left
19054	-	float	RD	Wh	Real energy L1
19056	-	float	RD	Wh	Real energy L2
19058	-	float	RD	Wh	Real energy L3
19060	-	float	RD	Wh	Real energy L1..L3
19062	-	float	RD	Wh	Real energy L1, consumed
19064	-	float	RD	Wh	Real energy L2, consumed
19066	-	float	RD	Wh	Real energy L3, consumed
19068	-	float	RD	Wh	Real energy L1..L3, consumed, rate 1
19070	-	float	RD	Wh	Real energy L1, delivered
19072	-	float	RD	Wh	Real energy L2, delivered
19074	-	float	RD	Wh	Real energy L3, delivered
19076	-	float	RD	Wh	Real energy L1..L3, delivered
19078	-	float	RD	VAh	Apparent energy L1
19080	-	float	RD	VAh	Apparent energy L2
19082	-	float	RD	VAh	Apparent energy L3
19084	-	float	RD	VAh	Apparent energy L1..L3
19086	-	float	RD	varh	Reactive energy L1
19088	-	float	RD	varh	Reactive energy L2
19090	-	float	RD	varh	Reactive energy L3
19092	-	float	RD	varh	Reactive energy L1..L3

Modbus address	Address via Display	Format	RD/WR	Unit	Note
19094	-	float	RD	varh	Reactive energy, inductive, L1
19096	-	float	RD	varh	Reactive energy, inductive, L2
19098	-	float	RD	varh	Reactive energy, inductive, L3
19100	-	float	RD	varh	Reactive energy L1..L3, ind.
19102	-	float	RD	varh	Reactive energy, capacitive, L1
19104	-	float	RD	varh	Reactive energy, capacitive, L2
19106	-	float	RD	varh	Reactive energy, capacitive, L3
19108	-	float	RD	varh	Reactive energy L1..L3, cap.
19110	836	float	RD	%	Harmonic, THD, U L1-N
19112	838	float	RD	%	Harmonic, THD, U L2-N
19114	840	float	RD	%	Harmonic, THD, U L3-N
19116	908	float	RD	%	Harmonic, THD, I L1
19118	910	float	RD	%	Harmonic, THD, I L2
19120	912	float	RD	%	Harmonic, THD, I L3

Modbus address	Address via display	Format	RD/WR	Unit	Note	Adjustment range	Default
20006	-	float	RD/WR	A	TDD I4, full-load current	0...1000000	150
20008	-	float	RD/WR	A	current transformer I4, primary	0...1000000	5
20010	-	float	RD/WR	A	current transformer I4, secondary	1..5	5
20012	-	float	RD/WR	A	current transformer I5, primary	0..1000000	5
20014	-	float	RD/WR	A	current transformer I5, secondary	0,001...5	5
20016	-	float	RD/WR	A	current transformer I6, primary	0...1000000	5
20018	-	float	RD/WR	A	current transformer I6, secondary	0,001...5	5

Number formats

Type	Size	Minimum	Maximum
short	16 bit	-2^{15}	$2^{15} - 1$
ushort	16 bit	0	$2^{16} - 1$
int	32 bit	-2^{31}	$2^{31} - 1$
uint	32 bit	0	$2^{32} - 1$
float	32 bit	IEEE 754	IEEE 754



Notes on saving measurement values and configuration data:

- The following measurement values are saved at least every 5 minutes:
 - Comparator timer
 - S0 meter readings
 - Minimum / maximum / mean values
 - Energy values
- Configuration data is saved immediately!

Dimension diagrams

All dimensions provided in mm

Rear view

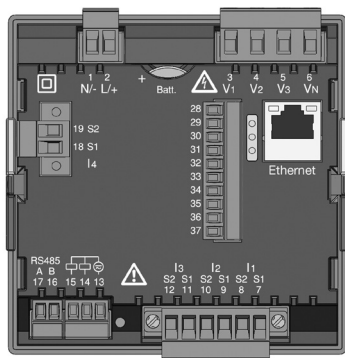

View from below

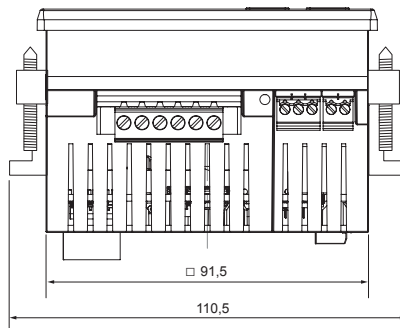

Side view

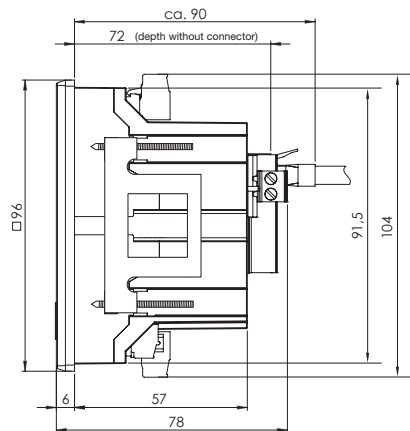

Cut-out size

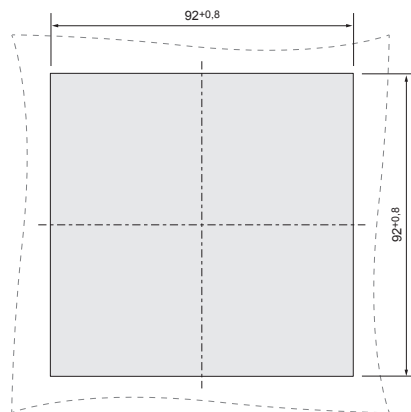

Measured value displays overview

▲ A01 Measured values L1-N voltage L2-N voltage L3-N voltage	▶ B01 Mean values L1-N voltage L2-N voltage L3-N voltage	▶ C01 Maximum values L1-N voltage L2-N voltage L3-N voltage	▶ D01 Minimum values L1-N voltage L2-N voltage L3-N voltage
▲ A02 Measured values L1-L2 voltage L2-L3 voltage L3-L1 voltage	B02 Mean values L1-L2 voltage L2-L3 voltage L3-L1 voltage	C02 Maximum values L1-L2 voltage L2-L3 voltage L3-L1 voltage	D02 Minimum values L1-L2 voltage L2-L3 voltage L3-L1 voltage
▲ A03 Measured values L1 current L2 current L3 current	B03 Mean values L1 current L2 current L3 current	C03 Maximum values L1 current L2 current L3 current	D03 Max. values (mean value) L1 current L2 current L3 current
▲ A04 Measured value Sum Current in the N line	B04 Mean value Sum Current in the N line	C04 Maximum value Measured value sum Current in the N line	D04 Maximum values Sum mean value Current in the N line
▲ A05 Measured values L1 active power L2 active power L3 active power	B05 Mean value L1 active power L2 active power L3 active power	C05 Maximum values L1 active power L2 active power L3 active power	
▲ A06 Measured value Sum Active power	B06 Mean value Sum Active power	C06 Maximum value Sum Active power	D06 Maximum value Sum Active power mean value
▲ A07 Measured values L1 apparent power L2 apparent power L3 apparent power	B07 Mean values L1 apparent power L2 apparent power L3 apparent power	C07 Maximum values L1 apparent power L2 apparent power L3 apparent power	

△	A08	▷	B08	▷	C08	▷
	Measured value Sum Apparent power		Mean value Sum Apparent power		Maximum value Sum Apparent power	
△	A09		B09		C09	
	Measured values L1 reactive power L2 reactive power L3 reactive power		Mean values L1 reactive power L2 reactive power L3 reactive power		Maximum values (ind) L1 reactive power L2 reactive power L3 reactive power	
△	A10		B10		C10	
	Measured value Sum of reactive power		Mean value Sum of reactive power		Maximum value (ind) Sum of reactive power	
△	A11		B11		C11	
	Measured value Distortion factor (THD) U L1		Measured value Distortion factor (THD) U L2		Measured value Distortion factor (THD) U L3	
△	A12		B12		C12	
	Measured value Distortion factor (THD) I L1		Measured value Distortion factor (THD) I L2		Measured value Distortion factor (THD) I L3	
△	A13		B13		C13	
	Maximum value Distortion factor (THD) U L1		Maximum value Distortion factor (THD) U L2		Maximum value Distortion factor (THD) U L3	
△	A14		B14		C14	
	Maximum value Distortion factor (THD) I L1		Maximum value Distortion factor (THD) I L2		Maximum value Distortion factor (THD) I L3	

△	A15						
	Measured value L1 cos(phi) L2 cos(phi) L3 cos(phi)						
△	A16	B16					
	Measured value Sum of cos(phi)	Mean value Sum of cos(phi)					
△	A17						
	Measured value Frequency L1 Rotation field display						
△	A18	B18	C18	D18	E18	F18	G18
	Measured value Total active energy (without a backstop)	Measured value Total active energy (import)	Measured value Total active energy (export)	Measured value Sum Apparent energy	Measured value Active energy L1 Import (tariff 1)	Measured value Active energy L2 Import (tariff 1)	Measured value Active energy L3 Import (tariff 1)
△	A19	B19	C19	D19	E19	F19	
	Measured value (ind) Reactive energy	Measured value Sum Reactive energy cap.	Measured value Sum Reactive energy ind.	Measured value Reactive energy L1 ind. (tariff 1)	Measured value Reactive energy L2 ind. (tariff 1)	Measured value Reactive energy L3 ind. (tariff 1)	
△	A20	B20		G20			
	Operating hours meter 1	Comparator 1A* Total running time	...	Comparator 2C* Total running time			
△	A21	B21		H21			
	Measured value 1st. harmonic U L1	Measured value 3rd. harmonic U L1	...	Measured value 15th. harmonic U L1			

Marked menus are not displayed in the factory presetting.

* Only the first 6 comparators are shown.

△ A22	▷ B22	▷ H22
Measured value 1st. harmonic U L2	Measured value 3rd. harmonic U L2	Measured value 15th. harmonic U L2
...
△ A23	B23	H23
Measured value 1st. harmonic U L3	Measured value 3rd. harmonic U L3	Measured value 15th. harmonic U L3
...
△ A24	B24	H24
Measured value 1st. harmonic I L1	Measured value 3rd. harmonic I L1	Measured value 15th. harmonic I L1
...
△ A25	B25	H25
Measured value 1st. harmonic I L2	Measured value 3rd. harmonic I L2	Measured value 15th. harmonic I L2
...
△ A26	B26	H26
Measured value 1st. harmonic I L3	Measured value 3rd. harmonic I L3	Measured value 15th. harmonic I L3
...
△ A27	B27	H27
Maximum value 1st. harmonic U L1	Maximum value 3rd. harmonic U L1	Maximum value 15th. harmonic U L1
...
△ A28	B28	H28
Maximum value 1st. harmonic U L2	Maximum value 3rd. harmonic U L2	Maximum value 15th. harmonic U L2
...

Marked menus are not displayed in the factory presetting.

A29 Maximum value 1st. harmonic U L3	B29 Maximum value 3rd. harmonic U L3	...	H29 Maximum value 15th. harmonic U L3
A30 Maximum value 1st. harmonic I L1	B30 Maximum value 3rd. harmonic I L1	...	H30 Maximum value 15th. harmonic I L1
A31 Maximum value 1st. harmonic I L2	B31 Maximum value 3rd. harmonic I L2	...	H31 Maximum value 15th. harmonic I L2
A32 Maximum value 1st. harmonic I L3	B32 Maximum value 3rd. harmonic I L3	...	H32 Maximum value 15th. harmonic I L3
A33 Measured values L4 current	B33 Mean values L4 current	C33 Maximum values L4 current	D33 Max. values (mean value) L4 current
A34 Measured values L5 current	B34 Mean values L5 current	C34 Maximum values L5 current	D34 Max. values (mean value) L5 current
A35 Measured values L6 current	B35 Mean values L6 current	C35 Maximum values L6 current	D35 Max. values (mean value) L6 current

Marked menus are not displayed in the factory presetting.

Even and **odd** harmonics up to the **40th order** can be called up via the GridVis software and can be viewed in the software.

Declaration of conformity

The product fulfils the following EC Directives:	
2004/108/EG	Electromagnetic compatibility of electrical equipment.
2006/95/EG	Electrical equipment for use within certain voltage limits.
Considered standards:	
Noise immunity IEC/EN 61326-1:2013 IEC/EN 61000-4-2:2009 IEC/EN 61000-4-3:2011 IEC/EN 61000-4-4:2013 IEC/EN 61000-4-5:2007 IEC/EN 61000-4-6:2009 IEC/EN 61000-4-8:2010 IEC/EN 61000-4-11:2005	Class A: Industrial environment Electrostatic discharge Electromagnetic RF Field 80-2700MHz Burst Surge Conducted disturbances 0,15-80MHz Power frequency magnetic field Voltage dips, short interrupts, voltage variations and frequency changes
Noise emission IEC/EN 61326-1:2013 IEC/CISPR11/EN 55011:2011 IEC/CISPR11/EN 55011:2011	Class B: Residential environment Radio disturbance field strength 30-1000MHz Radio disturbance voltage 0.15-30MHz
Equipment safety IEC/EN 61010-1:2011 IEC/EN 61010-2-030:2011	Safety requirements for electrical equipment for Measurement, control and laboratory use – Part 1: General requirements Particular requirements for testing and measuring circuits

Connection example 1

(with residual current measurement IPE / IRES)

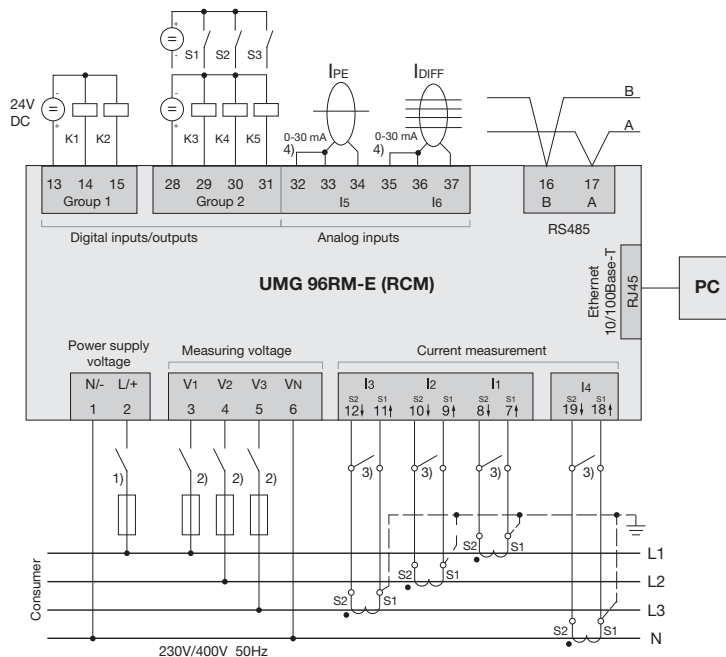

- 1) UL / IEC approved overcurrent protection system (6A type C)
- 2) UL / IEC approved overcurrent protection system (10A type C)
- 3) Jumpers (external)
- 4) Jumpers between connectors 32-33 and 35-36 are only required from hardware-release 104!

Connection example 2

(with temperature and residual current measurement)

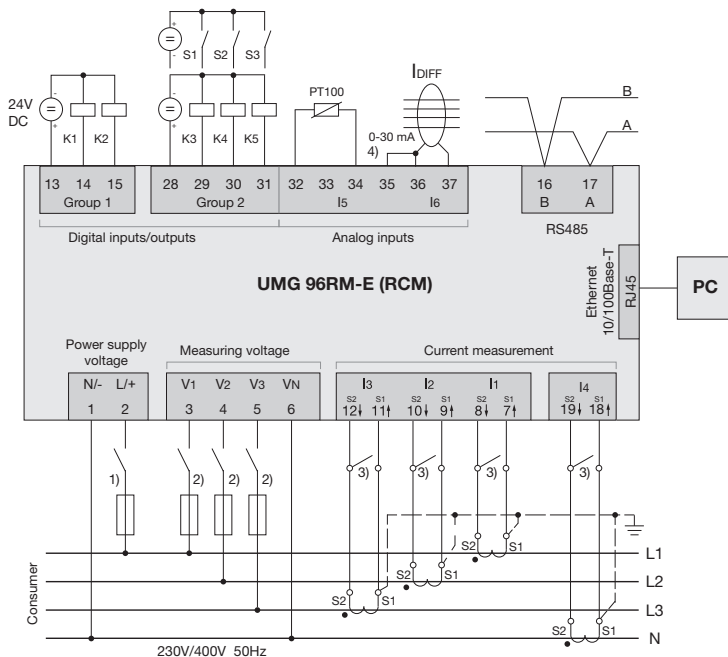

- 1) UL / IEC approved overcurrent protection system (6A type C)
- 2) UL / IEC approved overcurrent protection system (10A type C)
- 3) Jumpers (external)
- 4) Jumpers between connectors 35-36 are only required from hardware-release 104!

Basic functions quick guide

Adjusting the current transformer

Switch to the programming mode:

- Press button 1 and 2 simultaneously for around 1 second to switch to the programming mode. The symbols for the programming mode PRG and the current transformer mode CT appear on the display.
- Press button 1 to confirm the selection.
- The first digit of the input field for the primary current is flashing.

Adjusting the primary current

- Press button 2 to change the flashing digit.
- Press button 1 to select the next digit to be changed. The selected digit to be changed is flashing. If the entire number is flashing, press button 2 to move the decimal point.

Adjusting the secondary current

- Only 1A or 5A can be set as secondary current.
- Press button 1 to select the secondary current.
- Press button 2 to change the flashing digit.

Exit programming mode

- Press button 1 and 2 simultaneously for around 1 second to switch to the display mode.

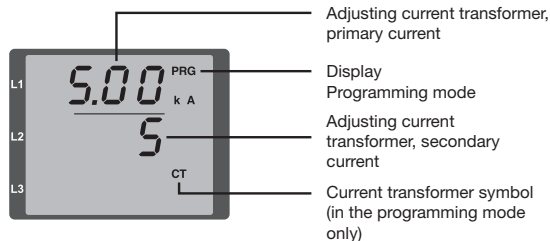

View measured values

Switch to the display mode:

- If you are still in the programming mode (PRG and CT icons displayed on the screen), press button 1 and 2 simultaneously for around 1 second to switch to the display mode.
- A measured value display (e.g. voltage) appears

Button controls

- Press button 2 to change the measured value display for current, voltage, power, etc.
- Press button 1 to change the mean values, max. values etc. associated with the measured value.

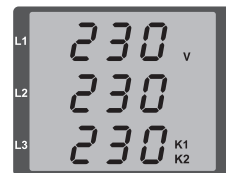

TCP/IP addressing quick guide

Manual TCP/IP settings

Switch to the programming mode:

- Press button 1 and 2 simultaneously for around 1 second to switch to the programming mode. The symbols for the programming mode PRG and the current transformer mode CT appear on the display.

Adjust the TCP/IP address (Adr.)

- Press button 2 to select "Adr"
- Press button 1 to enable the first digit (byte 0) of the address (digit is flashing). Press button 2 to set the digit.
- Press button 1 to select the next digit (flashing) and set the desired digit by pressing button 2.
- If byte is set to 0, the address can be set from 1 to 3 by pressing button 1. Then the display jumps back to Byte 0 (**no** digit is flashing).

Subnet mask (SUB)

- Press button 2 to select the subnet mask and set it in a manner similar to adjusting the address by pressing button 1 and 2.

Adjusting the gateway address (GAt)

- Use button 2 and 1 to set the gateway in a manner similar to adjusting the address.

Exit programming mode

- Press button 1 and 2 simultaneously to exit the mode or wait 60 seconds.

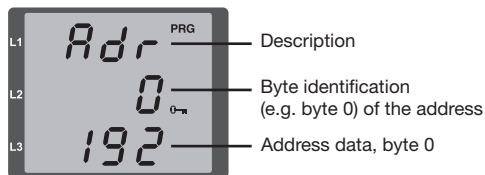
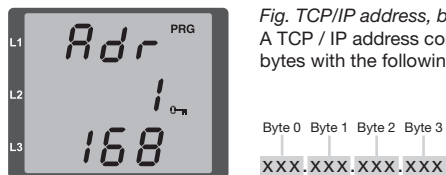

Fig. TCP/IP address, byte 1
A TCP / IP address consists of 4 bytes with the following structure:



Enable dynamic IP allocation (dyn)

Device/gateway address and subnet mask are assigned by a DHCP server and enable automatic integration of the device into the existing mains.

- When in programming mode, press button 2 repeatedly to display the tab labelled "dYn IP".
- Press button 1 to enable the parameter "on" or "off" (parameter is flashing). Press button 2 to set the desired status and press button 1 to confirm the selection.
- Exit programming mode.